

Facade

2026 | 04 |



Products

Legerair / FLAT DESIGN PANEL / Neorock Photocatalytic Ceramic Coating /
FilltectN Photocatalytic Ceramic Coating / FilltectE Photocatalytic Ceramic Coating /
Excellage Photocatalytic Ceramic Coating



Dirt is decomposed by sunlight

Decomposition Power

Dirt is decomposed by the sun (Ultraviolet Rays), weakening adhesion.

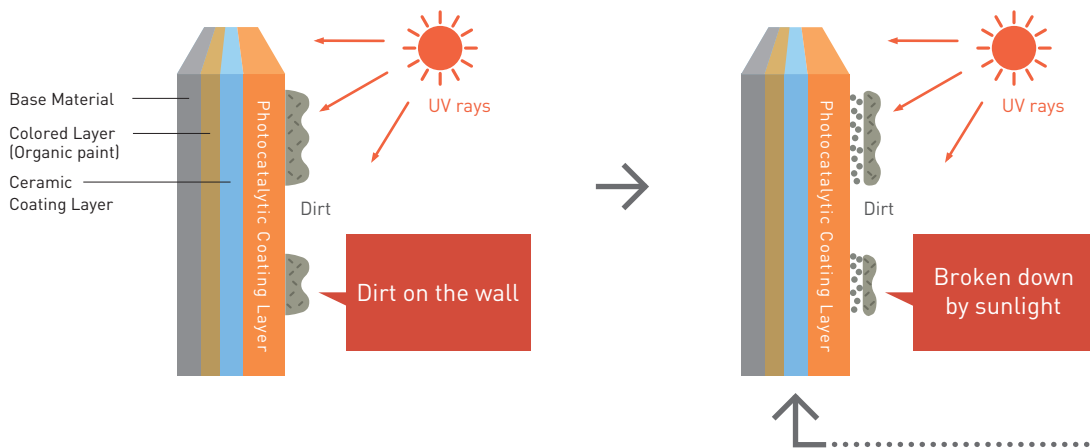

A home that is eco-friendly

Air-purifying Function

Photocatalytic coat decomposes pollutants in the air and exhaust gas (NOx and SOx) into clean air .

The air purification capability of Photocatalytic coat of 165m² is worth 12 poplars.

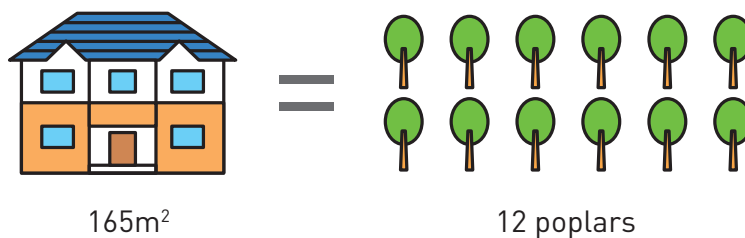

*Assuming a poplar tree's air purifying capability (NO2) is 0.57g / day

Compatibility with water allows for easy cleaning.

Super Hydrophilic Property

Due to the extreme compatibility with water, rainwater rinses off dirt.

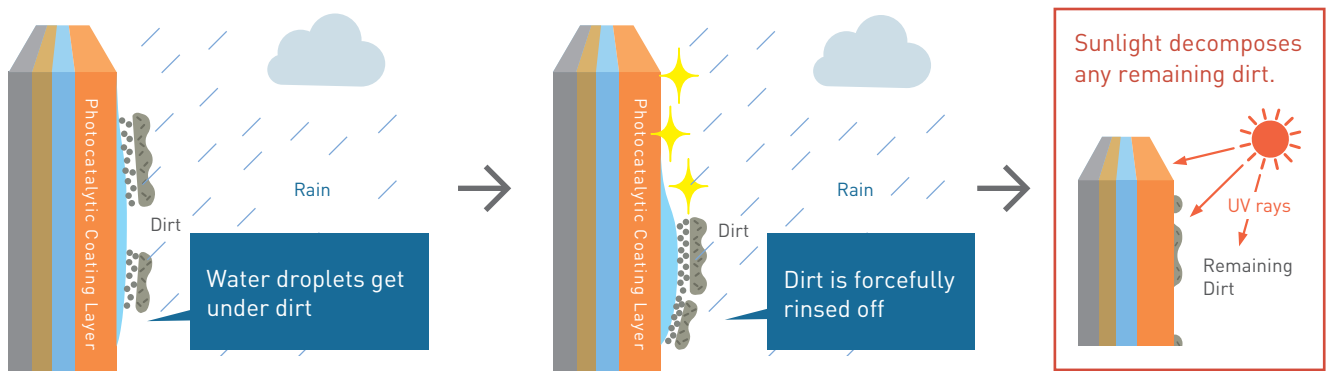

The ceramic coating layer offers strong protection against fading and sunburning

Super Weather Resistance

The double effects of the inorganic resin and the inorganic UV absorber protects against over time and cuts UV rays.

Point 1: Inorganic resin

The main framework is 100% inorganic with bonds that are strengthened by UV energy to prevent deterioration over time.

■ Molecular structure diagram

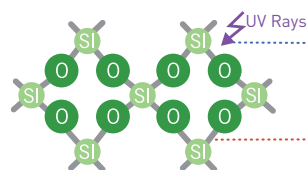

Bonds are not easily broken

Molecular Bonds

413 KJ / mol
Kilo jules per mole

443KJ / mol

Increased strength from UV energy to prevent bonds from being easily broken

Point 2: Inorganic UV absorber

The inorganic construction helps prevent deterioration and is able to cut UV rays.



Products

Neorock Hydrophilic coating / Excellage Hydrophilic coating /
FilltectN Hydrophilic coating / FilltectE Hydrophilic coating /
Ceradir Hydrophilic coating



Compatibility with water
allows for easy cleaning.

Washed away by rainwater. Water gets on the dirt and washes the dirt away

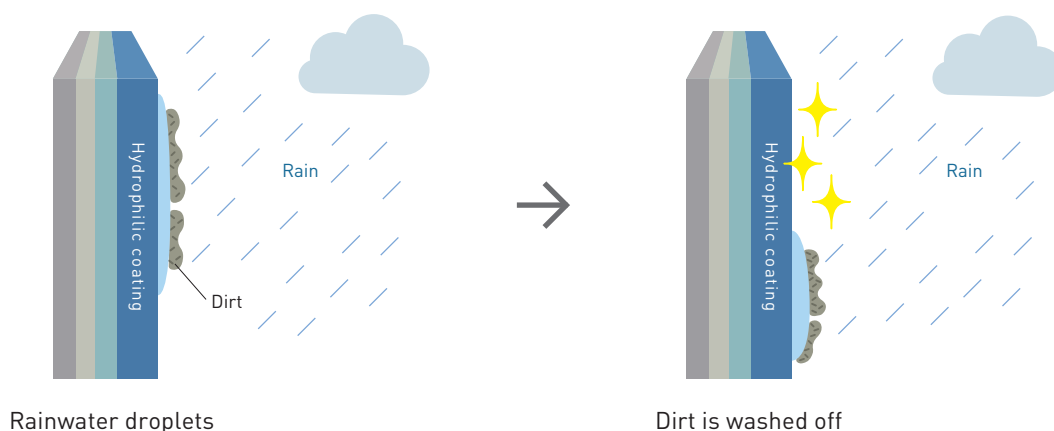

Advanced hydrophilic coating technology helps wash away dirt accumulated on the panel with rainwater. After panel being cleaned with rainwater from dirt, moisture remains on the hydrophilic surface. The color coating is strongly protected from moisture.

Hydrophilic

The panel structure is formed from the substrate, base paint protective clear coating and hydrophilic coating.

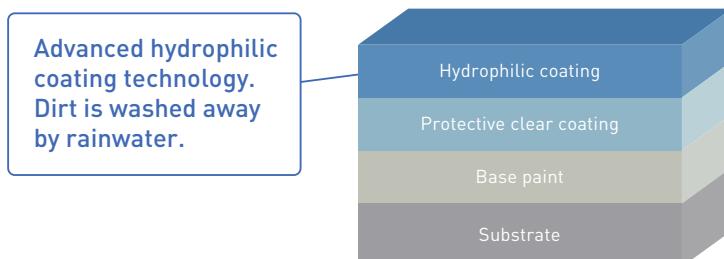





Filltect N Photocatalytic Ceramic Coating 16

Filltect E Photocatalytic Ceramic Coating 16

Filltect N Photocatalytic Ceramic Coating 16 Ceratopia

Gemma FT
 New Inplace FT
 Barn Wood FT
 Brulee Wood FT
 Fierte FT
 Board Formed Concrete FT

Filltect N Photocatalytic Ceramic Coating 16

Ridge Wave FT
 Accurate FT
 New Slim Stone FT
 Natural Brick FT
 Ofen Brick FT
 Tiers Tile FT
 Drawer Tile FT
 Sephiro Wood FT
 Urban Cedar FT
 Sho Sugi Ban FT
 Smash Line FT
 Stripe 10 FT
 Modern Slit FT
 Strahl FT
 Fiotto FT
 Scre Flat FT
 Cast Stripe FT
 Cashmere Smooth FT
 Zen Garden FT
 3 Reveal FT
 8 Reveal FT

■ Joint Alignment & Connection Sections

Joint Alignment with Caulking

- To enhance the natural appearance of the design, the joint width intentionally varies.
 In addition, the joints on both sides of the caulking may be misaligned by approximately 3mm.
- The joint width varies to create a natural design expression.
- The joints on either side of the caulking may be offset by around 3mm.

Connection Sections

A joint is placed every approx. 455mm in the vertical direction.
 Depending on lighting conditions, sunlight, or viewing angle, subtle shadows or slight gaps may appear along the joint lines.

■ Performance List

item	unit	Filltect N Photocatalytic Ceramic Coating 16	Filltect E Photocatalytic Ceramic Coating 16	note
		16mm thickness		
specific gravity	—	1.0*	1.2*	Drying at 105°C for 24 hours
Water content	%	20 or under	20 or under	JISA5422
Water absorption rate	%	50 or under	50 or under	Water absorption 24h→105°C 24h
Bending Failure Load	N	785 or over	785 or over	JISA5422
Impact resistance	—	Passed	Passed	JISA5422

*These are our measured values.

Filltect N Photocatalytic Ceramic Coating 16 Ceratopia

16 mm thickness | Filltect N Photocatalytic Ceramic Coating 16 Ceratopia

16×455×3030(mm) | 11,000JPY/piece 7,980JPY/m²

Photocatalytic
Self-
cleaning

Weather
resistance grade
★★★

Gemma FT

Installation
Horizontal



FH7241A



FH7242A



FH7243A

New Inplace FT

Installation
Horizontal



FH7251A



FH7252A

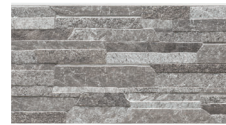

FH7253A

Barn Wood FT

Installation
Horizontal
and
Vertical



HFH7521A



HFH7522A



HFH7523A



HFH7524A



HFH7526A

Brulee Wood FT

Installation
Horizontal
and
Vertical



FH7261A

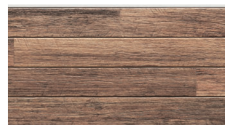

FH7263A



FH7265A

Fierte FT

Installation
Horizontal
and
Vertical



FH7272A



FH7274A

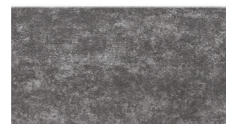

FH7275A

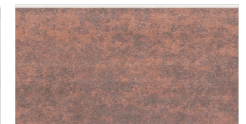

FH7276A



FH7277A

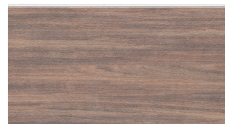

FH7278A



FH7279A

Board Formed Concrete FT

Installation
Horizontal
and
Vertical



HFH7431A



HFH7432A



HFH7433A

Filltect N Photocatalytic Ceramic Coating 16

16 mm thickness | Filltect N Photocatalytic Ceramic Coating 16

16x455x3030(mm) | 10,300JPY/piece 7,470JPY/m²

Photocatalytic
Self-
cleaning

Weather
resistance grade
★★★

Ridge Wave FT

Installation
Horizontal



FH4911U



FH4913U



FH4914U

Accurate FT

Installation
Horizontal



FH7131U



FH7133U



FH7134U

New Slim Stone FT

Installation
Horizontal
and
Vertical



FH4865K



FH4867K



FH4868K



FH4869K

Natural Brick FT

Installation
Horizontal



FH4925U



FH4926U



FH4927U

Ofen Brick FT

Installation
Horizontal



FH7155A



FH7156A



FH7157A



FH7158A

Tiers Tile FT

Installation
Horizontal



FH7141A



FH7142A



FH7143A

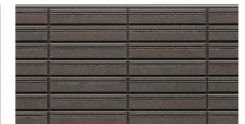

FH7144A



FH7145A



FH7146A

Filltect N Photocatalytic Ceramic Coating 16

16 mm thickness | Filltect N Photocatalytic Ceramic Coating 16

16×455×3030(mm) | 10,300JPY/piece 7,470JPY/m²

Photocatalytic
Self-
cleaning

Weather
resistance grade
★★★

Drawer Tile FT

Installation
Horizontal



FH4935U



FH4937U



FH4938U

Sephiro Wood FT

Installation
Horizontal
and
Vertical



FH4875U



FH4878U



FH4879U



FH48710U



FH48712U



FH48713U

Urban Cedar FT

Installation
Horizontal
and
Vertical



HFH7451U



HFH7452U



HFH7453U



HFH7454U



HFH7455U



HFH7456U

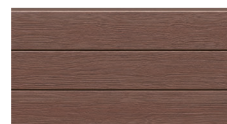

HFH7457U



HFH7458U

16×455×3030(mm) | 10,000JPY/piece 7,250JPY/m²

Sho Sugi Ban FT

Installation
Horizontal
and
Vertical



HFH5481U



HFH5491U

Smash Line FT

Installation
Horizontal



FH4885K



FH4886K



FH4887K



FH4888K

Stripe 10 FT

Installation
Horizontal
and
Vertical



FH7161K



FH7162K



FH7163K



FH7164K

Modern Slit FT

Installation
Horizontal
and
Vertical



HFH9181U



HFH9182U



HFH9183U



HFH9184U



HFH9185U



HFH9186U



HFH9187U



HFH9188U



HFH9189U



HFH91810U

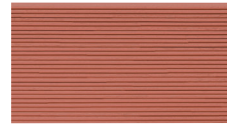

HFH91812U



HFH91814U



HFH91816U



HFH91817U

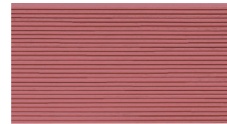

HFH91818U

Strahl FT

Installation
Horizontal

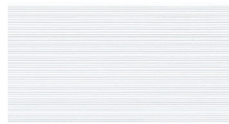

FH7171K



FH7172K



FH7173K



FH7175K

Fiotto FT

Installation
Horizontal
and
Vertical



FH4895U



FH4896U



FH4898U



FH4899U

Scre Flat FT

Installation
Horizontal
and
Vertical

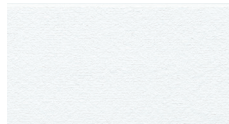

FH7281A

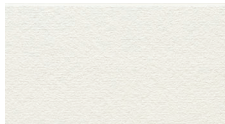

FH7282A

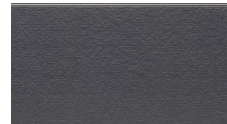

FH7283A

Cast Stripe FT

Installation
Horizontal
and
Vertical



HFH7461U



HFH7462U



HFH7463U



HFH7464U

Filltect N Photocatalytic Ceramic Coating 16

16 mm thickness | Filltect N Photocatalytic Ceramic Coating 16

16×455×3030(mm) | 10,000JPY/piece 7,250JPY/m²

Photocatalytic
Self-
cleaning

Weather
resistance grade
★★★

Cashmere Smooth FT

Installation
Horizontal
and
Vertical



Zen Garden FT

Installation
Horizontal
and
Vertical



3 Reveal FT



8 Reveal FT



Gemma FT

Coating performance	Weather resistance	Installation
Photocatalytic Self-cleaning	Weather resistance grade ★★★	Installation Horizontal



FH7241A



FH7242A



FH7243A

Specifications

Size	16×455(exposed width)×3030mm
Price	11,000 JPY /piece 7,980 JPY/m ²
Number of panel per package	2 pieces
Coverage	1.38m ² /piece
Weight	Approx. 23kg/piece

Outside corner

Outside corner l=455

16×outside:91(inside:75)
×455(exposed width)

Accessories list

Genuine accessories are required to install siding panels

Panel	Accessories	Outside corner l=455	Caulking (Holder set: B80E)
FH7241A		FHD7241A	B8430978
FH7242A		FHD7242A	B8430979
FH7243A		FHD7243A	B84301847
Price		4,800 JPY /piece	6,600 JPY /piece
Number of panel per package		10 pieces/box (Ordering Unit 1piece)	10 pieces/box ^{*1} (Ordering Unit 1piece) Caulking(600ml)10pieces,Primer,brush,nozzle2pieces
*Holder set are sold separately			

*1 The dedicated primer (part number B85AA or B85BB) will be shipped at the same time.

New Inplace FT

Coating performance	Weather resistance	Installation
Photocatalytic Self-cleaning	Weather resistance grade ★★★	Installation Horizontal



FH7251A



FH7252A



FH7253A

Specifications

Size	16×455(exposed width)×3030mm
Price	11,000 JPY /piece 7,980 JPY/m ²
Number of panel per package	2pieces
Coverage	1.38m ² /piece
Weight	Approx. 24kg/piece

Outside corner

Outside corner l=455

16×outside:91(inside:75)
×455(exposed width)

Accessories list

Genuine accessories are required to install siding panels

Panel	Accessories	Outside corner l=455	Caulking (Holder set: B80E)
FH7251A		FHD7251A	B84302999
FH7252A		FHD7252A	B84304013
FH7253A		FHD7253A	B84301843
Price		4,800 JPY /piece	6,600 JPY /piece
Number of panel per package		10 pieces/box (Ordering Unit 1piece)	10 pieces/box ^{*1} (Ordering Unit 1piece) Caulking(600ml)10pieces,Primer,brush,nozzle2pieces
*Holder set are sold separately			

*1 The dedicated primer (part number B85AA or B85BB) will be shipped at the same time.

Barn Wood FT

Coating performance	Weather resistance	Installation
Photocatalytic Self-cleaning	Weather resistance grade ★★	Installation Horizontal and Vertical



HFH7521A



HFH7522A



HFH7523A



HFH7524A



HFH7526A

Specifications

Size	16×455(exposed width)×3030mm
Price	11,000JPY/piece 7,980JPY/m ²
Number of panel per package	2pieces
Coverage	1.38m ² /piece
Weight	Approx. 25kg/piece

Outside corner

Outside corner l=455	Outside corner l=3030
16×outside:91(inside:75)×455(exposed width)	16×outside:91(inside:75)×3030

Accessories list

Genuine accessories are required to install siding panels

Panel	Accessories	Outside corner l=455	Outside corner l=3030	Through Wall Flashing l=3030	Caulking (Holder set: B80E)
HFH7521A		HFHD7521A	HFHL7521A	B2241557	B84302980
HFH7522A		HFHD7522A	HFHL7522A	B22413113	B84302831
HFH7523A		HFHD7523A	HFHL7523A	B2241W3	B84302982
HFH7524A		HFHD7524A	HFHL7524A	B2241441	B84302864
HFH7526A		HFHD7526A	HFHL7526A	B2241460	B84304099
Price		4,800JPY/piece	21,500JPY/piece	3,200JPY/piece	6,600JPY/piece
Number of panel per package		10 pieces/box (Ordering Unit 1piece)	1piece	5 pieces/box	10 pieces/box [*] (Ordering Unit 1piece) Caulking(600ml)10pieces, Primer,brush,nozzle2pieces
<small>*Holder set are sold separately</small>					

*1 The dedicated primer (part number B85AA or B85BB) will be shipped at the same time.

Brulee Wood FT

Coating performance	Weather resistance	Installation
Photocatalytic Self-cleaning	Weather resistance grade ★★	Installation Horizontal and Vertical



FH7261A



FH7263A



FH7265A

Specifications

Size	16×455(exposed width)×3030mm
Price	11,000JPY /piece 7,980JPY/m ²
Number of panel per package	2pieces
Coverage	1.38m ² /piece
Weight	Approx. 25kg/piece

Outside corner

Shiplap corner

Vertical installation with clips

Outside corner l=455 Outside corner l=3030

16×outside:91(inside:75) ×455(exposed width) 16×outside:91(inside:75) ×3030

Accessories list

Genuine accessories are required to install siding panels

Panel	Accessories	Outside corner l=455	Outside corner l=3030	Through Wall Flashing l=3030	Caulking (Holder set: B80E)
FH7261A		FHD7261A	FHP7261A	B2241557	B84302955
FH7263A		FHD7263A	FHP7263A	B22412606	B84302956A
FH7265A		FHD7265A	FHP7265A	B22413114	B84302415
Price		4,800JPY /piece	21,500JPY /piece	3,200JPY /piece	6,600JPY /piece
Number of panel per package		10 pieces/box (Ordering Unit: 1piece)	1piece	5 pieces/box	10 pieces/box* (Ordering Unit: 1piece) Caulking(600ml)10pieces, Primer,brush, nozzle2pieces
*Holder set are sold separately					

*1 The dedicated primer (part number B85AA or B85BB) will be shipped at the same time.

Fierte FT

Coating performance	Weather resistance	Installation
Photocatalytic Self-cleaning	Weather resistance grade ★★★	Installation Horizontal and Vertical



FH7272A



FH7274A

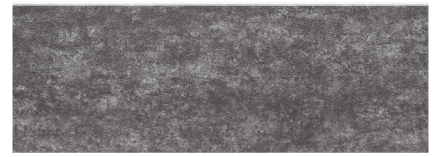

FH7275A



FH7276A



FH7277A



FH7278A



FH7279A

Specifications

Size	16×455(exposed width)×3030mm
Price	11,000JPY /piece 7,980JPY/m ²
Number of panel per package	2pieces
Coverage	1.38m ² /piece
Weight	Approx. 24kg/piece

Outside corner

Outside corner l=455 Outside corner l=3030

Shiplap corner
Vertical installation with clips

16×outside:91(inside:75)×455(exposed width) 16×outside:91(inside:75)×3030

Accessories list

Genuine accessories are required to install siding panels

Panel	Accessories	Outside corner l=455	Outside corner l=3030	Through Wall Flashing l=3030	Caulking (Holder set: B80E)
FH7272A		FHD7272A	FHP7272A	B2241557	B84303887
FH7274A		FHD7274A	FHP7274A	B2241550	B84303891
FH7275A		FHD7275A	FHP7275A	B2241549	B84303892
FH7276A		FHD7276A	FHP7276A	B2241476	B84303939
FH7277A		FHD7277A	FHP7277A	B2241512	B84303937
FH7278A		FHD7278A	FHP7278A	B22413113	B8430442
FH7279A		FHD7279A	FHP7279A	B2241557	B84302949
Price		4,800JPY/piece	21,500JPY/piece	3,200JPY/piece	6,600JPY/piece
Number of panel per package		10 pieces/box (Ordering Unit 1piece)	1piece	5 pieces/box	10 pieces/box*1 (Ordering Unit 1piece) Caulking(600ml)10pieces, Primer,brush,nozzle,2pieces
*Holder set are sold separately					

*1 The dedicated primer (part number B85AA or B85BB) will be shipped at the same time.

Board Formed Concrete FT

Coating performance	Weather resistance	Installation
Photocatalytic Self-cleaning	Weather resistance grade ★★	Installation Horizontal and Vertical



HFH7431A



HFH7432A





HFH7433A

Specifications

Size	16×455(exposed width)×3030mm
Price	11,000JPY /piece 7,980JPY/m ²
Number of panel per package	2pieces
Coverage	1.38m ² /piece
Weight	Approx. 26kg/piece

Outside corner

Outside corner l=455  16×outside:91(inside:75) ×455(exposed width)	Outside corner l=3030  16×outside:91(inside:75) ×3030
---	--

Accessories list

Genuine accessories are required to install siding panels

Panel	Accessories	Outside corner l=455	Outside corner l=3030	Through Wall Flashing l=3030	Caulking (Holder set: B80E)
HFH7431A		HFHD7431A	HFHL7431A	RE224557	B84302879
HFH7432A		HFHD7432A	HFHL7432A	RE224557	B84302880
HFH7433A		HFHD7433A	HFHL7433A	B224550	B84301823
Price		4,800JPY/piece	21,500JPY/piece	3,200JPY/piece	6,600JPY/piece
Number of panel per package		10 pieces/box (Ordering Unit 1piece)	1piece	5 pieces/box	10 pieces/box [*] (Ordering Unit 1piece) Caulking(600ml)10pieces, Primer,brush, nozzle2pieces
<small>*Holder set are sold separately</small>					

*1 The dedicated primer (part number B85AA or B85BB) will be shipped at the same time.

Ridge Wave FT

Coating performance	Weather resistance	Installation
Photocatalytic Self-cleaning	Weather resistance grade ★★★	Installation Horizontal



FH4911U



FH4913U



FH4914U

Specifications

Size	16×455(exposed width)×3030mm
Price	10,300 JPY /piece 7,470 JPY/m ²
Number of panel per package	2pieces
Coverage	1.38m ² /piece
Weight	Approx. 24kg/piece

Outside corner



Accessories list

Genuine accessories are required to install siding panels

Panel	Accessories	Outside corner l=455	Caulking (Holder set: B80E)
FH4911U		FHD4911U	B84303859
FH4913U		FHD4913U	B8430409
FH4914U		FHD4914U	B84303045
Price		4,400 JPY /piece	6,600 JPY /piece
Number of panel per package		10 pieces/box (Ordering Unit 1piece)	10 pieces/box ^{*1} (Ordering Unit 1piece) Caulking(600ml)10pieces,Primer,brush,nozzle2pieces
			*Holder set are sold separately

*1 The dedicated primer (part number B85AA or B85BB) will be shipped at the same time.

Accurate FT

Coating performance	Weather resistance	Installation
Photocatalytic Self-cleaning	Weather resistance grade ★★★	Installation Horizontal



FH7131U



FH7133U



FH7134U

Specifications

Size	16×455(exposed width)×3030mm
Price	10,300 JPY /piece 7,470 JPY/m ²
Number of panel per package	2 pieces
Coverage	1.38m ² /piece
Weight	Approx. 25kg/piece

Outside corner

Outside corner l=455

16×outside:91(inside:75)
×455(exposed width)

Accessories list

Genuine accessories are required to install siding panels

Panel	Accessories	Outside corner l=455	Caulking (Holder set: B80E)
FH7131U		FHD7131U	B84302491C
FH7133U		FHD7133U	B84303045
FH7134U		FHD7134U	B84303045
Price		4,400 JPY /piece	6,600 JPY /piece
Number of panel per package		10 pieces/box (Ordering Unit 1 piece)	10 pieces/box ^{*1} (Ordering Unit 1 piece) Caulking(600ml)10 pieces,Primer,brush,nozzle2 pieces
<small>*Holder set are sold separately</small>			

*1 The dedicated primer (part number B85AA or B85BB) will be shipped at the same time.

New Slim Stone FT

Coating performance	Weather resistance	Installation
Photocatalytic Self-cleaning	Weather resistance grade ★★★	Installation Horizontal and Vertical



FH4865K



FH4867K



FH4868K



FH4869K

Specifications

Size	16×455(exposed width)×3030mm
Price	10,300JPY /piece 7,470JPY/m ²
Number of panel per package	2pieces
Coverage	1.38m ² /piece
Weight	Approx. 24kg/piece

Outside corner

Outside corner l=455



16×outside:91(inside:75)
×455(exposed width)

Outside corner l=3030



16×outside:91(inside:75)
×3030

Shiplap corner



Vertical installation with clips

Accessories list

Genuine accessories are required to install siding panels

Panel	Accessories	Outside corner l=455	Outside corner l=3030	Through Wall Flashing l=3030	Caulking (Holder set: B80E)
FH4865K		FHD4865K	FHP4865K	B2241W2	B84301944
FH4867K		FHD4867K	FHP4867K	B2241W4	B84301937
FH4868K		FHD4868K	FHP4868K	B2241550	B84301935A
FH4869K		FHD4869K	FHP4869K	B22413114	B84303840
Price		4,400JPY/piece	19,800JPY/piece	3,200JPY/piece	6,600JPY/piece
Number of panel per package		10 pieces/box (Ordering Unit: 1piece)	1piece	5 pieces/box	10 pieces/box*1 (Ordering Unit: 1piece) Caulking(600ml)10pieces, Primer,brush,nozzle2pieces
*Holder set are sold separately					

*1 The dedicated primer (part number B85AA or B85BB) will be shipped at the same time.

Natural Brick FT

Coating performance	Weather resistance	Installation
Photocatalytic Self-cleaning	Weather resistance grade ★★	Installation Horizontal



FH4925U



FH4926U



FH4927U

Specifications

Size	16×455(exposed width)×3030mm
Price	10,300 JPY /piece 7,470 JPY/m ²
Number of panel per package	2 pieces
Coverage	1.38m ² /piece
Weight	Approx. 25kg/piece

Outside corner



Accessories list

Genuine accessories are required to install siding panels

Panel	Accessories	Outside corner l=455	Caulking (Holder set: B80E)
FH4925U		FHD4925U	B84302491A
FH4926U		FHD4926U	B8430746
FH4927U		FHD4927U	B8430427
Price		4,400 JPY /piece	6,600 JPY /piece
Number of panel per package		10 pieces/box (Ordering Unit 1 piece)	10 pieces/box ^{*1} (Ordering Unit 1 piece)
			Caulking(600ml)10pieces,Primer,brush,nozzle2pieces
			*Holder set are sold separately

*1 The dedicated primer (part number B85AA or B85BB) will be shipped at the same time.

Ofen Brick FT

Coating performance	Weather resistance	Installation
Photocatalytic Self-cleaning	Weather resistance grade ★★★	Installation Horizontal



FH7155A



FH7156A



FH7157A



FH7158A

Specifications

Size	16×455(exposed width)×3030mm
Price	10,300 JPY /piece 7,470 JPY/m ²
Number of panel per package	2 pieces
Coverage	1.38m ² /piece
Weight	Approx. 25kg/piece

Outside corner

Outside corner l=455

16×outside:91(inside:75)
×455(exposed width)

Accessories list

Genuine accessories are required to install siding panels

Panel	Accessories	Outside corner l=455	Caulking (Holder set: B80E)
FH7155A		FHD7155A	B84304047
FH7156A		FHD7156A	B84301843
FH7157A		FHD7157A	B8430409B
FH7158A		FHD7158A	B84301843
Price		4,400 JPY /piece	6,600 JPY /piece
Number of panel per package		10 pieces/box (Ordering Unit 1 piece)	10 pieces/box ^{*1} (Ordering Unit 1 piece) Caulking(600ml)10 pieces,Primer,brush,nozzle2 pieces
			<small>*Holder set are sold separately</small>

*1 The dedicated primer (part number B85AA or B85BB) will be shipped at the same time.

Tiers Tile FT

Coating performance	Weather resistance	Installation
Photocatalytic Self-cleaning	Weather resistance grade ★★★	Installation Horizontal



FH7141A



FH7142A



FH7143A



FH7144A



FH7145A



FH7146A

Specifications

Size	16×455(exposed width)×3030mm
Price	10,300JPY/piece 7,470JPY/m ²
Number of panel per package	2pieces
Coverage	1.38m ² /piece
Weight	Approx. 24kg/piece

Outside corner

Outside corner l=455

16×outside:91(inside:75)
×455(exposed width)

Accessories list

Genuine accessories are required to install siding panels

Panel	Accessories	Outside corner l=455	Caulking (Holder set: B80E)
FH7141A		FHD7141A	B84301843
FH7142A		FHD7142A	B84301843
FH7143A		FHD7143A	B84302417
FH7144A		FHD7144A	B84303045
FH7145A		FHD7145A	B84304047
FH7146A		FHD7146A	B84301843
Price		4,400JPY/piece	6,600JPY/piece
Number of panel per package		10 pieces/box (Ordering Unit 1piece)	10 pieces/box ^{*1} (Ordering Unit 1piece) Caulking(600ml)10pieces,Primer,brush,nozzle2pieces
			<small>*Holder set are sold separately</small>

*1 The dedicated primer (part number B85AA or B85BB) will be shipped at the same time.

Drawer Tile FT

Coating performance	Weather resistance	Installation
Photocatalytic Self-cleaning	Weather resistance grade ★★★	Installation Horizontal



FH4935U



FH4937U



FH4938U

Specifications

Size	16×455(exposed width)×3030mm
Price	10,300 JPY /piece 7,470 JPY/m ²
Number of panel per package	2 pieces
Coverage	1.38m ² /piece
Weight	Approx. 25kg/piece

Outside corner



Accessories list

Genuine accessories are required to install siding panels

Panel	Accessories	Outside corner l=455	Caulking (Holder set: B80E)
FH4935U		FHD4935U	B84303963
FH4937U		FHD4937U	B84302417B
FH4938U		FHD4938U	B8430713
Price		4,400 JPY /piece	6,600 JPY /piece
Number of panel per package		10 pieces/box (Ordering Unit 1 piece)	10 pieces/box ^{*1} (Ordering Unit 1 piece) Caulking(600ml)10pieces,Primer,brush,nozzle2pieces
			<small>*Holder set are sold separately</small>

*1 The dedicated primer (part number B85AA or B85BB) will be shipped at the same time.

Sephiro Wood FT

Coating performance	Weather resistance	Installation
Photocatalytic Self-cleaning	Weather resistance grade ★★★	Installation Horizontal and Vertical



FH4875U



FH4878U



FH4879U



FH48710U



FH48712U



FH48713U

Specifications

Size	16×455(exposed width)×3030mm
Price	10,300JPY/piece 7,470JPY/m ²
Number of panel per package	2pieces
Coverage	1.38m ² /piece
Weight	Approx. 24kg/piece

Outside corner

Outside corner l=455 Outside corner l=3030

Shiplap corner

Vertical installation with clips

16×outside:91(inside:75) ×455(exposed width) 16×outside:91(inside:75) ×3030

Accessories list

Genuine accessories are required to install siding panels

Panel	Accessories	Outside corner l=455	Outside corner l=3030	Through Wall Flashing l=3030	Caulking (Holder set: B80E)
FH4875U		FHD4875U	FHP4875U	B2241476	B84302833
FH4878U		FHD4878U	FHP4878U	B2241W3	B84302836
FH4879U		FHD4879U	FHP4879U	B22412606	B84302920
FH48710U		FHD48710U	FHP48710U	B2241W2	B8430495
FH48712U		FHD48712U	FHP48712U	B2241W1	B8430709
FH48713U		FHD48713U	FHP48713U	B2241W4	B84302636A
Price		4,400JPY/piece	19,800JPY/piece	3,200JPY/piece	6,600JPY/piece
Number of panel per package		10 pieces/box (Ordering Unit: 1piece)	1piece	5 pieces/box	10 pieces/box ^{*1} (Ordering Unit: 1piece) Caulking(600ml)10pieces, Primer,brush,nozzle2pieces
					*Holder set are sold separately

*1 The dedicated primer (part number B85AA or B85BB) will be shipped at the same time.

Urban Cedar FT

Coating performance	Weather resistance	Installation
Photocatalytic Self-cleaning	Weather resistance grade ★★★	Installation Horizontal and Vertical



HFH7451U



HFH7452U



HFH7453U



HFH7454U



HFH7455U

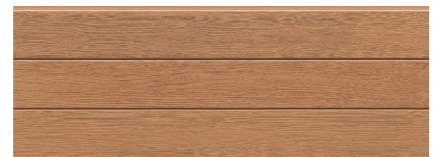

HFH7456U



HFH7457U



HFH7458U

Specifications

Size	16×455(exposed width)×3030mm
Price	10,300JPY /piece 7,470JPY/m ²
Number of panel per package	2pieces
Coverage	1.38m ² /piece
Weight	Approx. 25kg/piece

Outside corner

<p>Outside corner l=455</p> <p>16×outside:91(inside:75) ×455(exposed width)</p>	<p>Outside corner l=3030</p> <p>16×outside:91(inside:75) ×3030</p>
---	--

Accessories list

Genuine accessories are required to install siding panels

Panel	Accessories	Outside corner l=455	Outside corner l=3030
HFH7451U		HFHD7451U	HFHL7451U
HFH7452U		HFHD7452U	HFHL7452U
HFH7453U		HFHD7453U	HFHL7453U
HFH7454U		HFHD7454U	HFHL7454U
HFH7455U		HFHD7455U	HFHL7455U
HFH7456U		HFHD7456U	HFHL7456U
HFH7457U		HFHD7457U	HFHL7457U
HFH7458U		HFHD7458U	HFHL7458U
Price		4,400JPY /piece	19,800JPY /piece
Number of panel per package		10 pieces/box (Ordering Unit 1piece)	1piece

Sho Sugi Ban FT

Coating performance	Weather resistance	Installation
Photocatalytic Self-cleaning	Weather resistance grade ★★ ★	Installation Horizontal and Vertical



HFH5481U



HFH5491U

Specifications

Size	16×455(exposed width)×3030mm
Price	10,000JPY /piece 7,250JPY/m ²
Number of panel per package	2pieces
Coverage	1.38m ² /piece
Weight	Approx. 24kg/piece

Outside corner

Outside corner l=455 Outside corner l=3030

Shiplap corner

Vertical installation with clips

16×outside:91(inside:75) ×455(exposed width) 16×outside:91(inside:75) ×3030

Accessories list

Genuine accessories are required to install siding panels

Panel	Accessories	Outside corner l=455	Outside corner l=3030	Through Wall Flashing l=3030	Caulking (Holder set: B80E)
HFH5481U		HFHD5481U	HFHL5481U	B2241W1	B84303045
HFH5491U		HFHD5491U	HFHL5491U	B2241W1	B84303045
Price		4,400JPY /piece	19,800JPY /piece	3,200JPY /piece	6,600JPY /piece
Number of panel per package		10 pieces/box (Ordering Unit 1piece)	1piece	5 pieces/box	10 pieces/box*1 (Ordering Unit 1piece) Caulking(600ml)10pieces, Primer,brush,nozzle2pieces
*Holder set are sold separately					

*1 The dedicated primer (part number B85AA or B85BB) will be shipped at the same time.

Smash Line FT

Coating performance	Weather resistance	Installation
Photocatalytic Self-cleaning	Weather resistance grade ★★★	Installation Horizontal



FH4885K



FH4886K



FH4887K



FH4888K

Specifications

Size	16×455(exposed width)×3030mm
Price	10,000 JPY /piece 7,250 JPY/m ²
Number of panel per package	2 pieces
Coverage	1.38m ² /piece
Weight	Approx. 25kg/piece

Outside corner

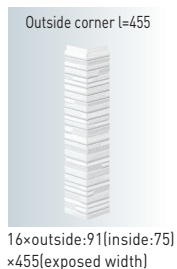

Accessories list

Genuine accessories are required to install siding panels

Panel	Accessories	Outside corner L=455	Caulking (Holder set: B80E)
FH4885K		FHD4885K	B84303044
FH4886K		FHD4886K	B84302491C
FH4887K		FHD4887K	B84301758A
FH4888K		FHD4888K	B84303045
Price		4,400 JPY /piece	6,600 JPY /piece
Number of panel per package		10 pieces/box (Ordering Unit 1 piece)	10 pieces/box ^{*1} (Ordering Unit 1 piece) Caulking(600ml)10 pieces,Primer,brush,nozzle2 pieces
			*Holder set are sold separately

*1 The dedicated primer (part number B85AA or B85BB) will be shipped at the same time.

Stripe 10 FT

Coating performance	Weather resistance	Installation
Photocatalytic Self-cleaning	Weather resistance grade ★★ ★	Installation Horizontal and Vertical



FH7161K



FH7162K



FH7163K



FH7164K

Specifications

Size	16×455(exposed width)×3030mm
Price	10,000JPY /piece 7,250JPY/m ²
Number of panel per package	2pieces
Coverage	1.38m ² /piece
Weight	Approx. 24kg/piece

Outside corner

Outside corner l=455 Outside corner l=3030

Shiplap corner

Vertical installation with clips

16×outside:91(inside:75) ×455(exposed width) 16×outside:91(inside:75) ×3030

Accessories list

Genuine accessories are required to install siding panels

Panel	Accessories	Outside corner l=455	Outside corner l=3030	Through Wall Flashing l=3030	Caulking (Holder set: B80E)
FH7161K		FHD7161K	FHP7161K	B2241W2	B84302491C
FH7162K		FHD7162K	FHP7162K	B2241549	B84303212
FH7163K		FHD7163K	FHP7163K	B2241462	B84301758A
FH7164K		FHD7164K	FHP7164K	B2241W3	B8430713
Price		4,400JPY/piece	19,800JPY/piece	3,200JPY/piece	6,600JPY/piece
Number of panel per package		10 pieces/box (Ordering Unit: 1piece)	1piece	5 pieces/box	10 pieces/box ^{*1} (Ordering Unit: 1piece) Caulking(600ml)10pieces, Primer,brush,nozzle2pieces
*Holder set are sold separately					

*1 The dedicated primer (part number B85AA or B85BB) will be shipped at the same time.

Modern Slit FT

Coating performance	Weather resistance	Installation
Photocatalytic Self-cleaning	Weather resistance grade ★★	Installation Horizontal and Vertical



Specifications

Size	16×455(exposed width)×3030mm
Price	10,000JPY /piece 7,250JPY/m ²
Number of panel per package	2pieces
Coverage	1.38m ² /piece
Weight	Approx. 25kg/piece

Outside corner

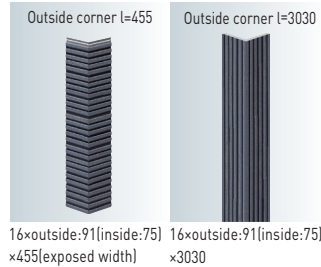

Accessories list

Genuine accessories are required to install siding panels

Panel	Accessories	Outside corner l=455	Outside corner l=3030
HFH9181U		HFHD9181U	HFHL9181U
HFH9182U		HFH9182U	HFHL9182U
HFH9183U		HFHD9183U	HFHL9183U
HFH9184U		HFHD9184U	HFHL9184U
HFH9185U		HFHD9185U	HFHL9185U
HFH9186U		HFH9186U	HFHL9186U
HFH9187U		HFH9187U	HFHL9187U
HFH9188U		HFHD9188U	HFHL9188U
HFH9189U		HFH9189U	HFHL9189U
HFH91810U		HFH91810U	HFHL91810U
HFH91812U		HFH91812U	HFHL91812U
HFH91814U		HFHD91814U	HFHL91814U
HFH91816U		HFH91816U	HFHL91816U
HFH91817U		HFH91817U	HFHL91817U
HFH91818U		HFH91818U	HFHL91818U
Price		4,400JPY /piece	19,800JPY /piece
Number of panel per package		10 pieces/box (Ordering Unit 1piece)	1piece

Strahl FT

Coating performance	Weather resistance	Installation
Photocatalytic Self-cleaning	Weather resistance grade ★★★	Installation Horizontal

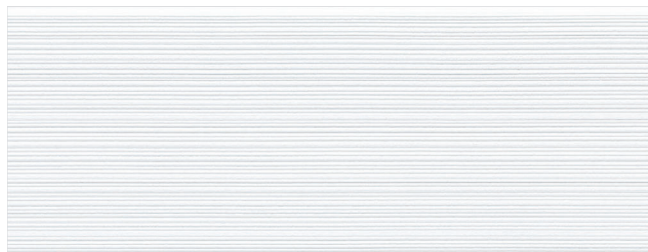

FH7171K

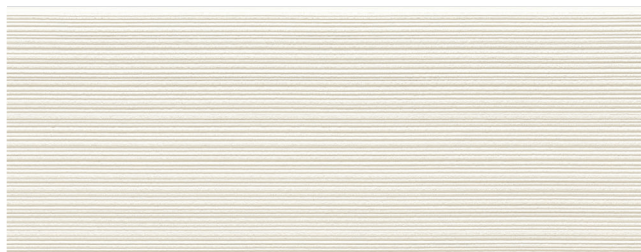

FH7172K



FH7173K



FH7175K

Specifications

Size	16×455(exposed width)×3030mm
Price	10,000 JPY /piece 7,250 JPY/m ²
Number of panel per package	2 pieces
Coverage	1.38m ² /piece
Weight	Approx. 24kg/piece

Outside corner

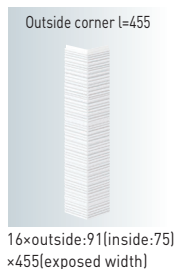

Accessories list

Genuine accessories are required to install siding panels

Panel	Accessories	Outside corner L=455	Caulking (Holder set: B80E)
FH7171K		FHD7171K	B84303051
FH7172K		FHD7172K	B84302491C
FH7173K		FHD7173K	B8430746
FH7175K		FHD7175K	B84303045
Price		4,400 JPY /piece	6,600 JPY /piece
Number of panel per package		10 pieces/box (Ordering Unit 1 piece)	10 pieces/box ^{*1} (Ordering Unit 1 piece) Caulking(600ml)10 pieces,Primer,brush,nozzle2 pieces
			<small>*Holder set are sold separately</small>

*1 The dedicated primer (part number B85AA or B85BB) will be shipped at the same time.

Fiotto FT

Coating performance	Weather resistance	Installation
Photocatalytic Self-cleaning	Weather resistance grade ★★★	Installation Horizontal and Vertical



FH4895U



FH4896U



FH4898U



FH4899U

Specifications

Size	16×455(exposed width)×3030mm
Price	10,000JPY /piece 7,250JPY/m ²
Number of panel per package	2pieces
Coverage	1.38m ² /piece
Weight	Approx. 24kg/piece

Outside corner

Outside corner l=455 Outside corner l=3030 Shiplap corner

Vertical installation with clips

16×outside:91(inside:75) ×455(exposed width) 16×outside:91(inside:75) ×3030

Accessories list

Genuine accessories are required to install siding panels

Panel	Accessories	Outside corner l=455	Outside corner l=3030	Through Wall Flashing l=3030	Caulking (Holder set: B80E)
FH4895U		FHD4895U	FHP4895U	B2241W2	B8430577
FH4896U		FHD4896U	FHP4896U	B2241W2	B8430495
FH4898U		FHD4898U	FHP4898U	B2241W3	B8430713
FH4899U		FHD4899U	FHP4899U	B2241557	B84302546
Price		4,400JPY /piece	19,800JPY /piece	3,200JPY /piece	6,600JPY /piece
Number of panel per package		10 pieces/box (Ordering Unit: 1piece)	1piece	5 pieces/box	10 pieces/box ^{*1} (Ordering Unit: 1piece) Caulking(600ml)10pieces, Primer,brush,nozzle2pieces
<small>*Holder set are sold separately</small>					

*1 The dedicated primer (part number B85AA or B85BB) will be shipped at the same time.

Scree Flat FT

Coating performance	Weather resistance	Installation
Photocatalytic Self-cleaning	Weather resistance grade ★★★	Installation Horizontal and Vertical

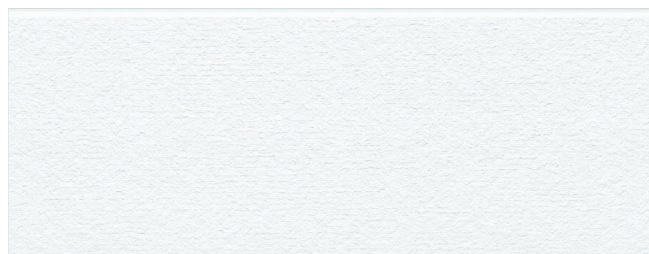

FH7281A

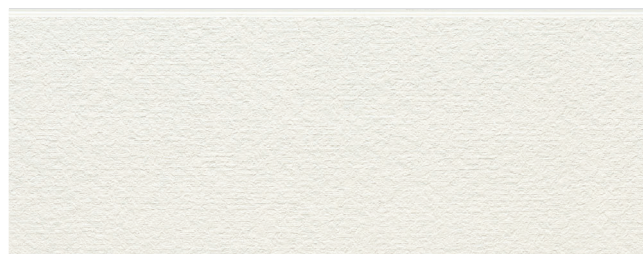

FH7282A



FH7283A

Specifications

Size	16×455(exposed width)×3030mm
Price	10,000JPY /piece 7,250JPY/m ²
Number of panel per package	2pieces
Coverage	1.38m ² /piece
Weight	Approx. 25kg/piece

Outside corner

Outside corner l=455 Outside corner l=3030 Shiplap corner

Vertical installation with clips

16×outside:91(inside:75) ×455(exposed width) 16×outside:91(inside:75) ×3030

Accessories list

Genuine accessories are required to install siding panels

Panel	Accessories	Outside corner l=455	Outside corner l=3030	Through Wall Flashing l=3030	Caulking (Holder set: B80E)
FH7281A		FHD7281A	FHP7281A	B22413058	B84303051
FH7282A		FHD7282A	FHP7282A	B2241W2	B84302491C
FH7283A		FHD7283A	FHP7283A	B2241W1	B84303045
Price		4,400JPY /piece	19,800JPY /piece	3,200JPY /piece	6,600JPY /piece
Number of panel per package		10 pieces/box (Ordering Unit 1piece)	1piece	5 pieces/box	10 pieces/box ^{*)} (Ordering Unit 1piece) Caulking(600ml)10pieces, Primer,brush, nozzle2pieces
*Holder set are sold separately					

*1 The dedicated primer (part number B85AA or B85BB) will be shipped at the same time.

Cast Stripe FT

Coating performance	Weather resistance	Installation
Photocatalytic Self-cleaning	Weather resistance grade ★★	Installation Horizontal and Vertical



HFH7461U



HFH7462U



HFH7463U



HFH7464U

Specifications

Size	16×455(exposed width)×3030mm
Price	10,000JPY /piece 7,250JPY/m ²
Number of panel per package	2pieces
Coverage	1.38m ² /piece
Weight	Approx. 25kg/piece

Outside corner

Outside corner l=455	Outside corner l=3030
16×outside:91(inside:75)×455(exposed width)	16×outside:91(inside:75)×3030

Accessories list

Genuine accessories are required to install siding panels

Panel	Accessories	Outside corner l=455	Outside corner l=3030
HFH7461U		HFHD7461U	HFHL7461U
HFH7462U		HFHD7462U	HFHL7462U
HFH7463U		HFHD7463U	HFHL7463U
HFH7464U		HFHD7464U	HFHL7464U
Price		4,400JPY /piece	19,800JPY /piece
Number of panel per package		10 pieces/box (Ordering Unit 1piece)	1piece

Cashmere Smooth FT

Coating performance	Weather resistance	Installation
Photocatalytic Self-cleaning	Weather resistance grade ★★★	Installation Horizontal and Vertical



Specifications

Size	16×455(exposed width)×3030mm
Price	10,000 JPY /piece 7,250 JPY/m ²
Number of panel per package	2pieces
Coverage	1.38m ² /piece
Weight	Approx. 26kg/piece

Outside corner

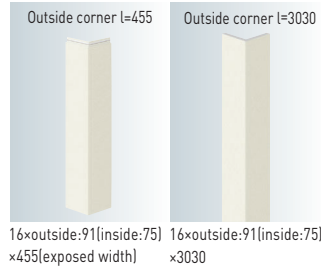

Accessories list

Genuine accessories are required to install siding panels

Panel	Accessories	Outside corner l=455	Outside corner l=3030
HFH9161A		HFHD9161A	HFHL9161A
HFH9162A		HFHD9162A	HFHL9162A
HFH9163A		HFHD9163A	HFHL9163A
HFH9164A		HFHD9164A	HFHL9164A
HFH9165A		HFHD9165A	HFHL9165A
HFH9166A		HFHD9166A	HFHL9166A
HFH9167A		HFHD9167A	HFHL9167A
HFH9168A		HFHD9168A	HFHL9168A
HFH9169A		HFHD9169A	HFHL9169A
HFH91610A		HFHD91610A	HFHL91610A
HFH91612A		HFHD91612A	HFHL91612A
HFH91614A		HFHD91614A	HFHL91614A
HFH91616A		HFHD91616A	HFHL91616A
HFH91617A		HFHD91617A	HFHL91617A
HFH91618A		HFHD91618A	HFHL91618A
Price		4,400 JPY /piece	19,800 JPY /piece
Number of panel per package		10 pieces/box (Ordering Unit 1piece)	1piece

Zen Garden FT

Coating performance	Weather resistance	Installation
Photocatalytic Self-cleaning	Weather resistance grade ★★★	Installation Horizontal and Vertical



Specifications

Size	16×455(exposed width)×3030mm
Price	10,000 JPY /piece 7,250 JPY/m ²
Number of panel per package	2pieces
Coverage	1.38m ² /piece
Weight	Approx. 22kg/piece

Outside corner

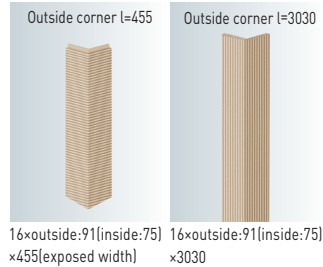

Accessories list

Genuine accessories are required to install siding panels

Panel	Accessories	Outside corner l=455	Outside corner l=3030
HFH9121U		HFHD9121U	HFHL9121U
HFH9122U		HFHD9122U	HFHL9122U
HFH9123U		HFHD9123U	HFHL9123U
HFH9124U		HFHD9124U	HFHL9124U
HFH9125U		HFHD9125U	HFHL9125U
HFH9126U		HFHD9126U	HFHL9126U
HFH9127U		HFHD9127U	HFHL9127U
HFH9128U		HFHD9128U	HFHL9128U
HFH9129U		HFHD9129U	HFHL9129U
HFH91210U		HFHD91210U	HFHL91210U
HFH91212U		HFHD91212U	HFHL91212U
HFH91214U		HFHD91214U	HFHL91214U
HFH91216U		HFHD91216U	HFHL91216U
HFH91217U		HFHD91217U	HFHL91217U
HFH91218U		HFHD91218U	HFHL91218U
Price		4,400 JPY /piece	19,800 JPY /piece
Number of panel per package		10 pieces/box (Ordering Unit 1piece)	1piece

3 Reveal FT

Coating performance	Weather resistance	Installation
Photocatalytic Self-cleaning	Weather resistance grade ★★	Installation Horizontal and Vertical



Specifications

Size	16×455(exposed width)×3030mm
Price	10,000 JPY /piece 7,250JPY/m ²
Number of panel per package	2pieces
Coverage	1.38m ² /piece
Weight	Approx. 25kg/piece

Outside corner



Accessories list

Genuine accessories are required to install siding panels

Panel	Accessories	Outside corner l=455	Outside corner l=3030
HFH9191A		HFHD9191A	HFHL9191A
HFH9192A		HFHD9192A	HFHL9192A
HFH9193A		HFHD9193A	HFHL9193A
HFH9194A		HFHD9194A	HFHL9194A
HFH9195A		HFHD9195A	HFHL9195A
HFH9196A		HFHD9196A	HFHL9196A
HFH9197A		HFHD9197A	HFHL9197A
HFH9198A		HFHD9198A	HFHL9198A
HFH9199A		HFHD9199A	HFHL9199A
HFH91910A		HFHD91910A	HFHL91910A
HFH91912A		HFHD91912A	HFHL91912A
HFH91914A		HFHD91914A	HFHL91914A
HFH91916A		HFHD91916A	HFHL91916A
HFH91917A		HFHD91917A	HFHL91917A
HFH91918A		HFHD91918A	HFHL91918A
Price		4,400 JPY /piece	19,800 JPY /piece
Number of panel per package		10 pieces/box (Ordering Unit 1piece)	1piece

8 Reveal FT

Coating performance	Weather resistance	Installation
Photocatalytic Self-cleaning	Weather resistance grade ★★	Installation Horizontal and Vertical



Specifications

Size	16×455(exposed width)×3030mm
Price	10,000 JPY /piece 7,250 JPY/m ²
Number of panel per package	2pieces
Coverage	1.38m ² /piece
Weight	Approx. 25kg/piece

Outside corner

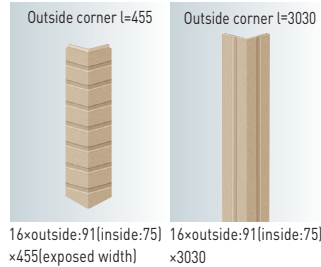

Accessories list

Genuine accessories are required to install siding panels

Panel	Accessories	Outside corner l=455	Outside corner l=3030
HFH9131U		HFHD9131U	HFHL9131U
HFH9132U		HFHD9132U	HFHL9132U
HFH9133U		HFHD9133U	HFHL9133U
HFH9134U		HFHD9134U	HFHL9134U
HFH9135U		HFHD9135U	HFHL9135U
HFH9136U		HFHD9136U	HFHL9136U
HFH9137U		HFHD9137U	HFHL9137U
HFH9138U		HFHD9138U	HFHL9138U
HFH9139U		HFHD9139U	HFHL9139U
HFH91310U		HFHD91310U	HFHL91310U
HFH91312U		HFHD91312U	HFHL91312U
HFH91314U		HFHD91314U	HFHL91314U
HFH91316U		HFHD91316U	HFHL91316U
HFH91317U		HFHD91317U	HFHL91317U
HFH91318U		HFHD91318U	HFHL91318U
Price		4,400 JPY /piece	19,800 JPY /piece
Number of panel per package		10 pieces/box (Ordering Unit 1piece)	1piece





Ceradir V 14

Ceramic Brick
 Erde Flat
 Oak
 Kloof
 Modern Stripe 5
 Modern Stripe 1
 Sottile

■ Joint Alignment & Connection Sections

Joint Alignment Across Joints

- To enhance the natural appearance of the design, the joint width intentionally varies.
 In addition, the joints on both sides of the joint may be misaligned by approximately 3mm.
- The joint width varies to create a natural design expression.
- The joints on either side of the joint may be offset by around 3mm.

Connection Sections

A joint is placed every approx. 455mm in the vertical direction.
 Depending on lighting conditions, sunlight, or viewing angle, subtle shadows or slight gaps may appear along the joint lines.

■ Performance List

item	unit	Ceradir V 14	note
		14mm thickness	
specific gravity	—	1.0*	Drying at 105°C for 24 hours
Water content	%	20 or under	JISA5422
Water absorption rate	%	50 or under	Water absorption 24h→105°C 24h
Bending Failure Load	N	785 or over	JISA5422
Impact resistance	—	Passed	JISA5422

*These are our measured values.

CeradirV14

14 mm thickness | CeradirV14

14×455×3000(mm) | 6,900JPY/piece 5,000JPY/m²

Hydrophilic
Self-
cleaning

Weather
resistance grade
★

Ceramic Brick

Installation
Horizontal



HCW2321GC



HCW2322GC



HCW2323GC



HCW2324GC



HCW2327GC

14×455×3030(mm) | 6,400JPY/piece 4,640JPY/m²

Erde Flat

Installation
Horizontal
and
Vertical

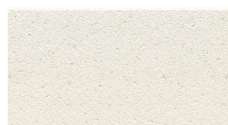

HCW2421GC



HCW2422GC



HCW2423GC

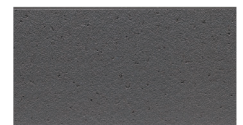

HCW2424GC

Oak

Installation
Horizontal
and
Vertical



HCW9141GC



HCW9142GC



HCW9143GC

Kloof

Installation
Horizontal



HCW1819GC

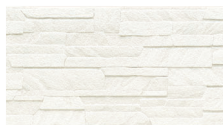

HCW18110GC



HCW18111GC

14 mm thickness | CeradirV14

14x455x3000(mm) | 5,800JPY/piece 4,210JPY/m²

Hydrophilic Self-cleaning
Weather resistance grade ★

Modern Stripe5

Installation
Horizontal
and
Vertical



HCW1567GC



HCW1568GC



HCW1569GC



HCW15610GC



HCW15614GC



HCW15615GC

Modern Stripe1

Installation
Horizontal
and
Vertical

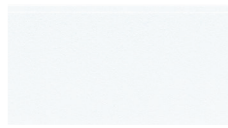

HCW9151GC



HCW9152GC



HCW9154GC



HCW9155GC



HCW9159GC



HCW91510GC



HCW91511GC



HCW91512GC

Sottile

Installation
Horizontal
and
Vertical



HCW1111GC



HCW1112GC



HCW1119GC



HCW11110GC



HCW11124GC



HCW11126GC



HCW11127GC



HCW11128GC



HCW11131GC

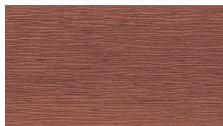

HCW11132GC



HCW11133GC

Ceramic Brick

Coating performance	Weather resistance	Installation
Hydrophilic Self-cleaning	Weather resistance grade ★	Installation Horizontal



HCW2321GC



HCW2322GC



HCW2323GC



HCW2324GC



HCW2327GC

Specifications

Size	14×455(exposed width)×3000mm
Price	6,900JPY /piece 5,000JPY/m ²
Number of panel per package	2pieces
Coverage	1.37m ² /piece
Weight	Approx. 20kg/piece

Accessories list

Genuine accessories are required to install siding panels

Panel	Accessories	Outside Metal Corner l=3030	T-shaped aluminum joiner	L-shaped aluminum joiner
HCW2321GC		B211512	B36F2	B36KF2
HCW2322GC		B211550	B36F4	B36KF4
HCW2323GC		B211476	B36F4	B36KF4
HCW2324GC		B211476	B36F3	B36KF3
HCW2327GC		B211W1	B36F1	B36KF1
Price		4,800JPY /piece	4,200JPY /piece	3,900JPY /piece
Number of packages		 5 pieces/box	15 pieces/box	15 pieces/box

Erde Flat

Coating performance	Weather resistance	Installation
Hydrophilic Self-cleaning	Weather resistance grade ★	Installation Horizontal and Vertical

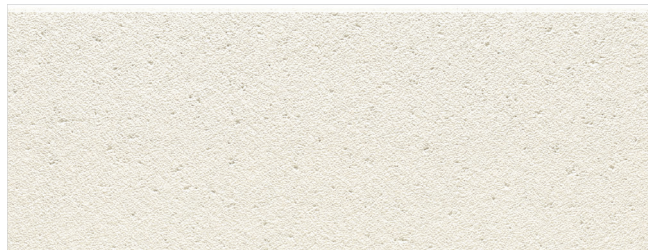

HCW2421GC



HCW2422GC

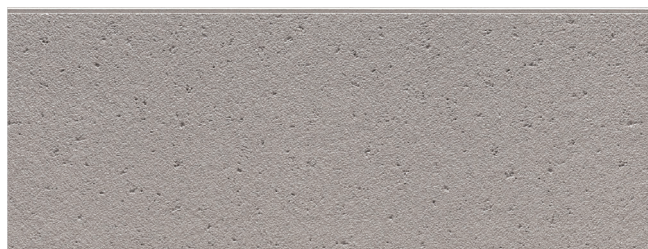

HCW2423GC



HCW2424GC

Specifications

Size	14×455(exposed width)×3000mm
Price	6,900JPY /piece 5,000JPY/m ²
Number of panel per package	2pieces
Coverage	1.37m ² /piece
Weight	Approx. 20kg/piece

Accessories list

Genuine accessories are required to install siding panels

Panel	Accessories	Outside Metal Corner l=3030	T-shaped aluminum joiner	L-shaped aluminum joiner
HCW2421GC		B211W2	B36F2	B36KF2
HCW2422GC		B211557	B36F2	B36KF2
HCW2423GC		B211550	B36F4	B36KF4
HCW2424GC		B211549	B36F1	B36KF1
Price		4,800JPY /piece	4,200JPY /piece	3,900JPY /piece
Number of packages		 5 pieces/box	15 pieces/box	15 pieces/box

Oak

Coating performance	Weather resistance	Installation
Hydrophilic Self-cleaning	Weather resistance grade ★	Installation Horizontal



HCW9141GC



HCW9142GC



HCW9143GC

Specifications

Size	14×455(exposed width)×3000mm
Price	6,400JPY /piece 4,640JPY/m ²
Number of panel per package	2pieces
Coverage	1.37m ² /piece
Weight	Approx. 20kg/piece

Accessories list Genuine accessories are required to install siding panels

Panel	Accessories	Outside Metal Corner l=3030	T-shaped aluminum joiner	L-shaped aluminum joiner
HCW9141GC		B211425	B36F4	B36KF4
HCW9142GC		B211459	B36F4	B36KF4
HCW9143GC		B211W3	B36F3	B36KF3
Price		4,800JPY /piece	4,200JPY /piece	3,900JPY /piece
Number of packages		 5 pieces/box	15 pieces/box	15 pieces/box

Kloof

Coating performance	Weather resistance	Installation
Hydrophilic Self-cleaning	Weather resistance grade ★	Installation Horizontal



HCW1819GC



HCW18110GC



HCW18111GC

Specifications

Size	14×455(exposed width)×3000mm
Price	6,400JPY /piece 4,640JPY/m ²
Number of panel per package	2pieces
Coverage	1.37m ² /piece
Weight	Approx. 19kg/piece

Accessories list

Genuine accessories are required to install siding panels

Panel	Accessories	Outside Metal Corner l=3030	T-shaped aluminum joiner	L-shaped aluminum joiner
HCW1819GC		B211549	B36F3	B36KF3
HCW18110GC		B211512	B36F2	B36KF2
HCW18111GC		B211459	B36F4	B36KF4
Price		4,800JPY /piece	4,200JPY /piece	3,900JPY /piece
Number of packages		 5 pieces/box	15 pieces/box	15 pieces/box

Modern Stripe 5

Coating performance	Weather resistance	Installation
Hydrophilic Self-cleaning	Weather resistance grade ★	Installation Horizontal and Vertical



HCW1567GC

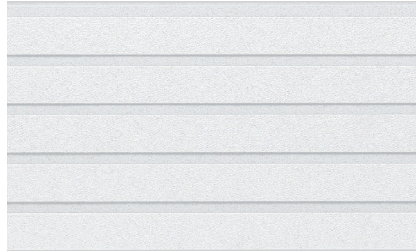

HCW1568GC



HCW1569GC



HCW15610GC



HCW15614GC



HCW15615GC

Specifications

Size	14×455(exposed width)×3000mm
Price	5,800JPY /piece 4,210JPY/m ²
Number of panel per package	2pieces
Coverage	1.37m ² /piece
Weight	Approx. 20kg/piece

Accessories list Genuine accessories are required to install siding panels

Panel	Accessories	Outside Metal Corner l=3030	T-shaped aluminum joiner	L-shaped aluminum joiner
HCW1567GC		B211W1	B36F1	B36KF1
HCW1568GC		B2113058	B36F2	B36KF2
HCW1569GC		B211557	B36F4	B36KF4
HCW15610GC		B2113057	B36F4	B36KF4
HCW15614GC		B211550	B36F4	B36KF4
HCW15615GC		B211476	B36F4	B36KF4
Price		4,800JPY /piece	4,200JPY /piece	3,900JPY /piece
Number of packages		 5 pieces/box	15 pieces/box	15 pieces/box

Modern Stripe 1

Coating performance	Weather resistance	Installation
Hydrophilic Self-cleaning	Weather resistance grade ★	Installation Horizontal and Vertical

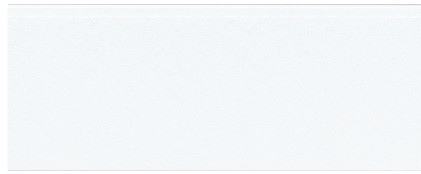

HCW9151GC

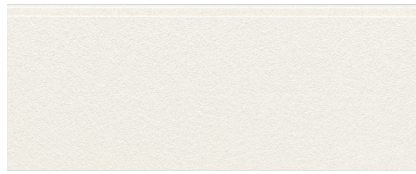

HCW9152GC



HCW9154GC



HCW9155GC



HCW9159GC



HCW91510GC



HCW91511GC



HCW91512GC

Specifications

Size	14×455(exposed width)×3000mm
Price	5,800JPY /piece 4,210JPY/m ²
Number of panel per package	2pieces
Coverage	1.37m ² /piece
Weight	Approx. 20kg/piece



*1 This pattern is a texture that blends well with the striped panels.

Accessories list

Genuine accessories are required to install siding panels

Panel	Accessories	Outside Metal Corner l=3030	T-shaped aluminum joiner	L-shaped aluminum joiner
HCW9151GC		B2113058	B36F2	B36KF2
HCW9152GC		B211512	B36F4	B36KF4
HCW9154GC		B211460	B36F4	B36KF4
HCW9155GC		B211557	B36F4	B36KF4
HCW9159GC		B211550	B36F4	B36KF4
HCW91510GC		B211476	B36F4	B36KF4
HCW91511GC		B211W1	B36F1	B36KF1
HCW91512GC		B211549	B36F4	B36KF4
Price		4,800JPY /piece	4,200JPY /piece	3,900JPY /piece
Number of packages		 5 pieces/box	15 pieces/box	15 pieces/box

Sottile

Coating performance	Weather resistance	Installation
Hydrophilic Self-cleaning	Weather resistance grade ★	Installation Horizontal and Vertical



HCW1111GC



HCW1112GC



HCW1119GC



HCW11110GC



HCW11124GC



HCW11126GC



HCW11127GC



HCW11128GC



HCW11131GC



HCW11132GC



HCW11133GC

Specifications

Size	14×455[Exposed width (length)]×3000
Price	5,800JPY /piece 4,210JPY/m ²
Number of panel per package	2pieces
Coverage	1.37m ² /piece
Weight	Approx. 20kg/piece

Accessories list

Genuine accessories are required to install siding panels

Panel	Accessories	Outside Metal Corner l=3030	T-shaped aluminum joiner	L-shaped aluminum joiner
HCW1111GC		B211512	B36F4	B36KF4
HCW1112GC		B211427	B36F4	B36KF4
HCW1119GC		B211462	B36F1	B36KF1
HCW11110GC		B211460	B36F4	B36KF4
HCW11124GC		B211476	B36F3	B36KF3
HCW11126GC		B211468	B36F4	B36KF4
HCW11127GC		B2113058	B36F2	B36KF2
HCW11128GC		B2113057	B36F4	B36KF4
HCW11131GC		B211550	B36F4	B36KF4
HCW11132GC		B211476	B36F4	B36KF4
HCW11133GC		B211W1	B36F1	B36KF1
Price		4,800JPY /piece	4,200JPY /piece	3,900JPY /piece
Number of packages		 5 pieces/box	15 pieces/box	15 pieces/box



Narrow shaped outside corner

Narrow shaped outside corner

Material: Coated galvanized steel



Narrow shaped outside corner for 18mm thickness panels brown



Narrow shaped outside corner for 16mm thickness panels gray



Installation Procedure 1
Install the Narrow shaped outside corner.



Installation Procedure 2
Cut a 45 degree angle at the siding edge. [Please use a tool which can cut a 45 degree angle at the siding edge.]



Installation Procedure 3
Install siding panel.

Narrow shaped outside corner for 18mm thickness panels				
Color	black	white	brown	gray
Shape				
Item number	B21611W1	B21611W2	B21611W3	B21611W4
Price	8,900JPY/piece			
Number of panel per package	4 pieces/box			

Narrow shaped outside corner for 16mm thickness panels				
Color	black	white	brown	gray
Shape				
Item number	B2151W1	B2151W2	B2151W3	B2151W4
Price	8,900JPY/piece			
Number of panel per package	4 pieces/box			

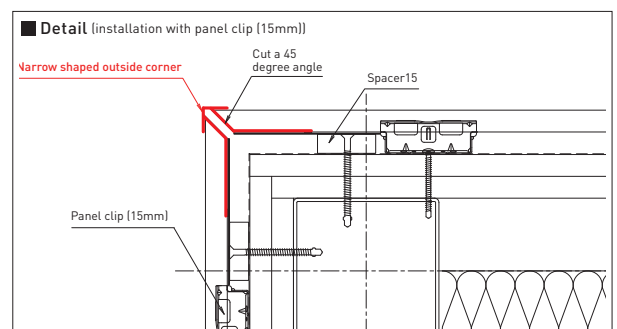

W shaped outside corner

W shaped outside corner

Material: Coated galvanized steel



W shaped outside corner for 18mm thickness panels brown



W shaped outside corner for 14mm thickness panels gray

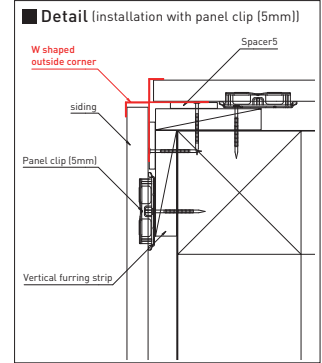

W shaped outside corner for 18mm thickness panels				
Color	black	white	brown	gray
Shape				
Item number	B21711W1	B21711W2	B21711W3	B21711W4
Price	11,400JPY/piece			
Number of panel per package	4 pieces/box			

W shaped outside corner for 16mm thickness panels				
Color	black	white	brown	gray
Shape				
Item number	B21721W1	B21721W2	B21721W3	B21721W4
Price	11,400JPY/piece			
Number of panel per package	4 pieces/box			

W shaped outside corner for 14mm thickness panels				
Color	black	white	brown	gray
Shape				
Item number	B21731W1	B21731W2	B21731W3	B21731W4
Price	7,000JPY/piece			
Number of panel per package	4 pieces/box			

Horizontal Application (for 5mm panel clip)

Products

Legerair

Filltect

Neorock

Excellage

Ceradier

Clip(5mm)				
	Panel Clip		Corner Clip	Starter bar for horizontal application
Shape				
Item number	B1005	B1305	B10053	B101052
Price	11,200JPY/bag	12,000JPY/bag	6,400JPY/bag	2,100JPY/piece
Number of panel per package	70 pieces/bag		50 pieces/bag	4 pieces/box
Material	Hot-dip zinc-aluminum magnesium alloy coated steel		Hot-dip zinc-aluminum magnesium alloy coated steel	Hot-dip zinc-aluminum magnesium alloy coated steel

Clip Fixing Component				
	Clip Screw35 (for wood substructure)	Clip Screw19 (for steel substructure)	Clip Screw16 (for steel substructure)	Clip Screw30 (for steel substructure)
Shape		<p>Sub Structure thickness :1.6 to 2.3mm</p>	<p>Sub Structure thickness :1.2mm</p>	<p>Sub Structure thickness :1.2mm</p>
Item number	B881135	RY8840	B885116	B885130
Price	10,500JPY/box	13,600JPY/box	15,100JPY/box	19,000JPY/box
Number of panel per package	500 pieces/box	500 pieces/box	500 pieces/box	500 pieces/box
Material	Stainless Steel	Stainless Steel	Stainless Steel	Stainless Steel

Spacer		
	Spacer5 (for openings and eaves)	Spacer2 (for land adjustment)
Shape		
Item number	RY82S05	RY82S02
Price	21,700JPY/box	18,000JPY/box
Number of panel per package	20 pieces/box	20 pieces/box
Material	Polypropylene	Polypropylene

Flashing		
Internal Flashing	Sill Flashing50	Through Wall Flashing For 18/16/15mm thickness
RCILK	black B238W1 white B238W2 brown B238W3 gray(metalic) B238W4	
1,400JPY/piece	3,200JPY/piece	3,200JPY/piece
20 pieces/box	5 pieces/box	5 pieces/box
Coated galvanized steel	Coated galvanized steel	Coated galvanized steel

Soffit Flashing		
	For 21/18mm thickness	For 16/15mm thickness
Shape		
Price	4,800JPY/piece	4,200JPY/piece
Number of panel per package	5 pieces/box	5 pieces/box
Material	Coated galvanized steel	Coated galvanized steel

Repair Component
B4901
3,700JPY/piece
1 pieces/350g
Acrylic emulsion

Long Clip	
B10055	
3,800 JPY/piece	
6 pieces/box	
Hot-dip zinc-aluminum magnesium alloy coated steel	

Face Nail / Screw				
Face Nail50(for wood substructure)	Face Nail45(for wood substructure)	Face Screw50 (for steel substructure)	Face Screw45 (for steel substructure)	Face Screw35 (for steel substructure)
For 21/18mm thickness	For 16/15mm thickness			
B8750R400	B8745R400	B88501	B885245	B8852135
790 JPY/bag	580 JPY/bag	9,500 JPY/box	15,600 JPY/box	14,000 JPY/box
40 pieces/bag	40 pieces/bag	200 pieces/box	300 pieces/box	300 pieces/box
Stainless Steel	Stainless Steel	Stainless Steel	Stainless Steel	Stainless Steel

Joint Component			
Metal Caulking Joiner			
For 15mm thickness	For 15mm thickness(one-side)	For 16mm or more thickness	For 16mm or more thickness(one-side)
B2715	B2715K	B2721	B2718K
1,900 JPY/piece	1,800 JPY/piece	2,000 JPY/piece	2,000 JPY/piece
15 pieces/box	15 pieces/box	15 pieces/box	15 pieces/box
Hot-dip zinc-aluminum magnesium alloy coated steel			

Joint Component	
T-shaped joiner	L-shaped joiner
black B3616F1 white B3616F2 brown B3616F3 dark stainless B3616F4	black B3616KF1 white B3616KF2 brown B3616KF3 dark stainless B3616KF4
6,500 JPY/piece	6,100 JPY/piece
15 pieces/box	15 pieces/box
Aluminum	Aluminum

Waterproof Component	
Waterproof Sealer	Waterproof Sealer for Filteck
RM875	LTKBM3103C
3,600 JPY/bottle	23,300 JPY/bottle
1 bottle/100g	1 bottle/1liter
—	—

Virtical Application (for 5mm panel clip)

Products

Filltect

Neorock

Excellage



Ceradier

Clip(5mm)					
	Panel Clip		Corner Clip	Starter bar for vertical application	
				For 16/15mm thickness	For 18mm thickness
Shape					
Item number	B1005	B1305	RE10058	B130571	B1320572
Price	11,200JPY/bag	12,000JPY/bag	4,400JPY/bag	6,500JPY/piece	5,900JPY/piece
Number of panel per package	70 pieces/bag		34 pieces/bag	5 pieces/box	5 pieces/box
Material	Hot-dip zinc-aluminum magnesium alloy coated steel		Hot-dip zinc-aluminum magnesium alloy coated steel	Hot-dip zinc-aluminum magnesium alloy coated steel	Hot-dip zinc-aluminum magnesium alloy coated steel

Face Nail / Screw					
	Face Nail50(for wood substructure)	Face Nail45(for wood substructure)	Face Screw50 (for steel substructure)	Face Screw45 (for steel substructure)	Face Screw60 (for steel substructure)
	For 18mm thickness	For 16/15mm thickness			
Shape					
Item number	B8750R400	B8745R400	B88501	B885245	B885260
Price	790JPY/bag	580JPY/bag	9,500JPY/box	15,600JPY/box	12,500JPY/box
Number of panel per package	40 pieces/bag	40 pieces/bag	200 pieces/box	300 pieces/box	200 pieces/box
Material	Stainless Steel	Stainless Steel	Stainless Steel	Stainless Steel	Stainless Steel

Spacer			Flashing	
	Spacer5 (for openings and eaves)	Spacer2 (for land adjustment)	Internal Flashing	Sill Flashing 50
	Shape			
Item number	RY82S05	RY82S02	RCILK	B238W1 black B238W2 white B238W3 brown B238W4 gray(metalic)
Price	21,700JPY/box	18,000JPY/box	1,400JPY/piece	3,200JPY/piece
Number of panel per package	20 pieces/box	20 pieces/box	20 pieces/box	5 pieces/box
Material	Polypropylene	Polypropylene	Coated galvanized steel	Coated galvanized steel

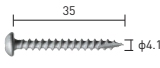
Repair Component		Waterproof Component	
	Repair Putty	Waterproof Sealer	Waterproof Sealer for Filltect
	Shape		
Item number	B4901	RM875	LTKBM3103C
Price	3,700JPY/piece	3,600JPY/bottle	23,300JPY/bottle
Number of panel per package	1 pieces/350g	1 bottle/100g	1 bottle/1liter
Material	Acrylic emulsion	—	—

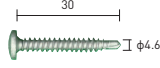
		Clip Fixing Component			
Corner cap for starter bar		Clip Screw35 (for wood substructure)	Clip Screw19 (for steel substructure)	Clip Screw16 (for steel substructure)	Clip Screw30 (for steel substructure)
			 Sub Structure thickness :1.6 to 2.3mm	 Sub Structure thickness :1.2mm	 Sub Structure thickness :1.2mm
	B293W1D	B881135	RY8840	B885116	B885130
	3,900JPY/bag	10,500JPY/box	13,600JPY/box	15,100JPY/box	19,000JPY/box
	10 pieces/bag	500 pieces/box	500 pieces/box	500 pieces/box	500 pieces/box
	Coated galvanized steel	Stainless Steel	Stainless Steel	Stainless Steel	Stainless Steel

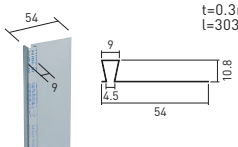
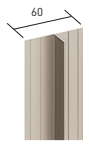
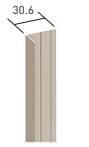
Joint Component		
Metal Caulking Joiner(one-side)	T-shaped joiner	L-shaped joiner
		
B2715K	black B3616F1 white B3616F2 brown B3616F3 dark stainless B3616F4	black B3616KF1 white B3616KF2 brown B3616KF3 dark stainless B3616KF4
1,800JPY/piece	6,500JPY/piece	6,100JPY/piece
15 pieces/box	15 pieces/box	15 pieces/box
Hot-dip zinc-aluminum magnesium alloy coated steel	Aluminum	Aluminum

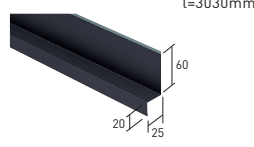
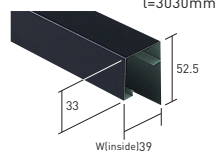
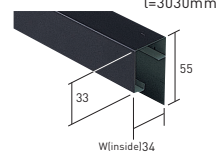
		Soffit Flashing	
Through Wall Flashing For 18/16/15mm thickness		For 21/18mm thickness	For 16/15mm thickness
			
	B257W1 white B257W2 brown B257W3 gray B257W4	black B256W1 white B256W2 brown B256W3 gray B256W4	
	3,200JPY/piece	4,800JPY/piece	4,200JPY/piece
	5 pieces/box	5 pieces/box	5 pieces/box
	Coated galvanized steel	Coated galvanized steel	Coated galvanized steel

Horizontal/Vertical Application (for 5mm panel clip)

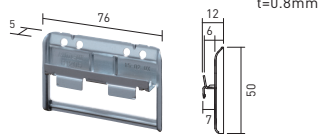
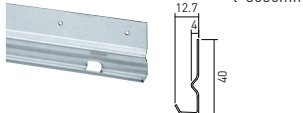
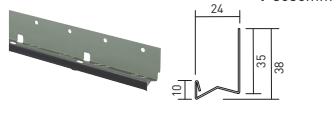

Products

Ceradier V14

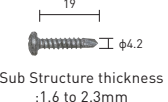
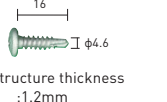
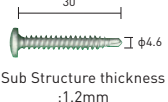
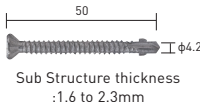
Clip(5mm)				
	Panel Clip	Starter bar for horizontal application	Starter bar for vertical application	
Shape				
Item number	B1205	B101052	B12057	
Price	12,700JPY /bag	2,100JPY /piece	4,100JPY /piece	
Number of panel per package	70 pieces/bag	4 pieces/box	5 pieces/box	
Material	Hot-dip zinc-aluminum magnesium alloy coated steel	Hot-dip zinc-aluminum magnesium alloy coated steel	Hot-dip zinc-aluminum magnesium alloy coated steel	

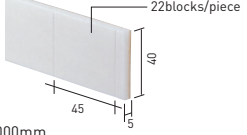
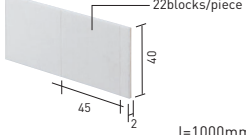
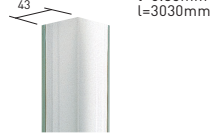
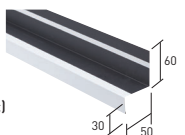
Clip Fixing Component				Face Screw
	Clip Screw19 (for steel substructure)	Clip Screw16 (for steel substructure)	Clip Screw30 (for steel substructure)	Face Screw50 (for steel substructure)
Shape				
Item number	RY8840	B885116	B885130	B88501
Price	13,600JPY /box	15,100JPY /box	19,000JPY /box	9,500JPY /box
Number of panel per package	500 pieces/box	500 pieces/box	500 pieces/box	200 pieces/box
Material	Stainless Steel	Stainless Steel	Stainless Steel	Stainless Steel

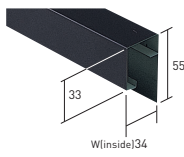

Spacer		Flashing		
	Spacer5 (for openings and eaves)	Spacer2 (for land adjustment)	Internal Flashing	Sill Flashing50
Shape				
Item number	RY82S05	RY82S02	RCILK	
Price	21,700JPY /box	18,000JPY /box	1,400JPY /piece	3,200JPY /piece
Number of panel per package	20 pieces/box	20 pieces/box	20 pieces/box	5 pieces/box
Material	Polypropylene	Polypropylene	Coated galvanized steel	Coated galvanized steel

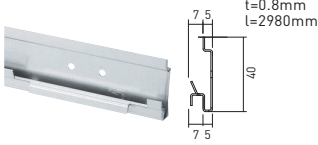
Flashing		Repair Component	Waterproof Component
	Soffit flashing	Repair Putty	Waterproof Sealer
Shape			
Price	4,200JPY /piece	3,700JPY /piece	3,600JPY /bottle
Number of panel per package	5 pieces/box	1 pieces/350g	1 bottle/100g
Material	Coated galvanized steel	Acrylic emulsion	—

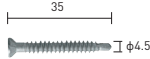
	Corner cap for starter bar	Long clip
		
	B291W1D	B12055
	3,500JPY/bag	6,900JPY/piece
	10 pieces/bag	6 pieces/box
	Coated galvanized steel	Hot-dip zinc-aluminum magnesium alloy coated steel

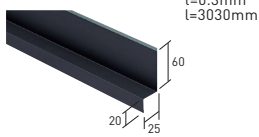
	Face Screw35 (for steel substructure)
	
	Sub Structure thickness :1.2mm
	B8852135
	14,000JPY/box
	300 pieces/box
	Stainless Steel

	Metal outside corner	Through wall flashing
		
	B211***	B224***
	4,800JPY/piece	3,200JPY/piece
	5 pieces/box	5 pieces/box
	Coated galvanized steel	Coated galvanized steel

Joint Component	
T-shaped joiner	L-shaped joiner
black B36F1 white B36F2 brown B36F3 dark stainless B36F4	black B36KF1 white B36KF2 brown B36KF3 dark stainless B36KF4
	
4,200JPY/piece	3,900JPY/piece
15 pieces/box	15 pieces/box
Aluminum	Aluminum

Cutting Blade / Guide Erde Flat



Based on internal testing

	Initial	Approx. 450 cuts	Approx. 3000 cuts
KMEW Blade			
Standard product			

Pattern deviation remains minimal even after 3000 cuts.

Significant pattern deviation has occurred.

Product Specifications

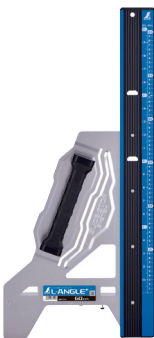
Product Name	KMEW Blade (φ125mm)	Guide
Material	 <p>Outer Diameter 125mm Inner Diameter 20mm Thickness 1.5mm Number of Blades 10</p>	
Part No.	B492	B49311
Suggested Retail Price	48,800 JPY /sheet	33,000 JPY /piece
Packaging Quantity	1 sheet	1 piece
Material	Diamond Chip	Aluminum
Operating Speed	15,000 rpm or less	—

- Always wear appropriate protective equipment such as safety goggles and a dust mask, and ensure that your clothing fits properly while working.
- Use a circular saw equipped with safety features and a dust collection system.
- Do not use this product for materials other than fiber-cement siding.
- Handle the diamond chips with care, as they are vulnerable to impact.
- Before use, make sure that the chip saw has no damage such as missing segments, cracks, warping, or abnormal wear on the blade.



Through Wall Flashing Metal Outside Corner Steel Color Chart

The color of the steel is set with the approximate color of the product.

● Through Wall Flasing

Item number	Color number
B2241400	400
B2241417	417
B2241422	422
B2241423	423
B2241425	425
B2241427	427
B2241441	441
B2241457	457
B2241459	459
B2241460	460
B2241461	461
B2241462	462
B2241468	468
B2241476	476
B2241512	512
B2241525	525
B2241549	549
B2241550	550
B2241557	557
B2241578	578
B22412606	2606
B22413057	3057
B22413058	3058
B22413060	3060
B22413113	3113
B22413114	3114
B2241W1	W1
B2241W2	W2
B2241W3	W3
B2241W4	W4

● Metal Outside Corner

Item number	Color number
B211400	400
B211417	417
B211423	423
B211425	425
B211427	427
B211439	439
B211441	441
B211457	457
B211459	459
B211460	460
B211462	462
B211468	468
B211476	476
B211512	512
B211525	525
B211528	528
B211549	549
B211550	550
B211557	557
B211578	578
B2112606	2606
B2113057	3057
B2113058	3058
B2113060	3060
B2113113	3113
B2113114	3114
B211W1	W1
B211W2	W2
B211W3	W3

Color Chart



Color number 400



Color number 417



Color number 422



Color number 423



Color number 425



Color number 427



Color number 439



Color number 441



Color number 457



Color number 459



Color number 460



Color number 461



Color number 462



Color number 468



Color number 476

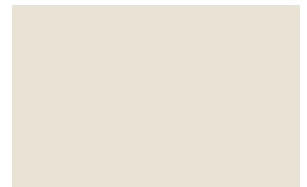

Color number 512



Color number 525



Color number 528



Color number 549

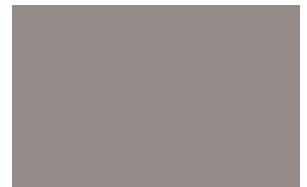

Color number 550

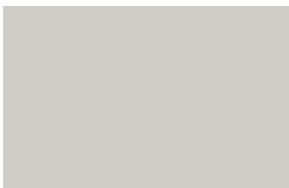

Color number 557

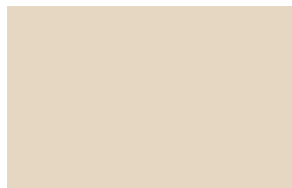

Color number 578



Color number 2606



Color number 3057

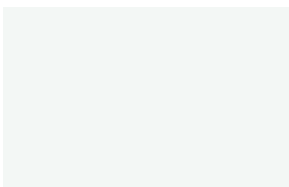

Color number 3058



Color number 3060



Color number 3113



Color number 3114



Color number W1

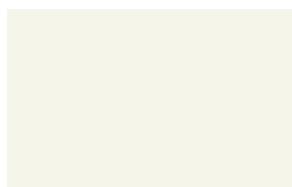

Color number W2



Color number W3



Color number W4

Repair Paint Color Chart

Filltect Photocatalytic Ceramic Coating 16

	Item number	Color number
	B962551BK	2551BK
	B961484EH	1484EH
	B961768CK	1768CK
	B962628BU	2628BU
	B963224AK	3224AK
	B962770BU	2770BU
Price	6,600JPY/box	
Number of package	1 set/box	
	Inorganic ever-drying type Paint Base(10g)1piece,Hardener(7g)1piece, Primer(7.5g)1piece,brush2pieces	

Color Chart

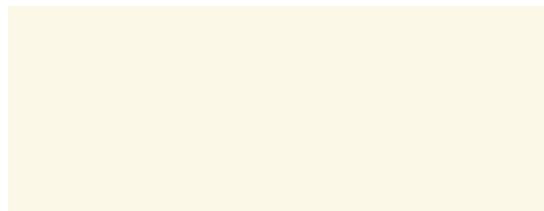

Color number 2551BK



Color number 1484EH



Color number 1768CK



Color number 2628BU



Color number 3224AK



Color number 2770BU

Repair Paint Color Chart

Filltect Hydrophilic 16 / CeradirV14

	Item number	Color number
	B93HB428	428
	B93HB427	427
	B93HB1714	1714
	B93HB2741C	2741C
	B93HB669C	669C
	B93HB2654A	2654A
Price	2,900JPY/piece	
Number of package	60g/bottle	

Color Chart

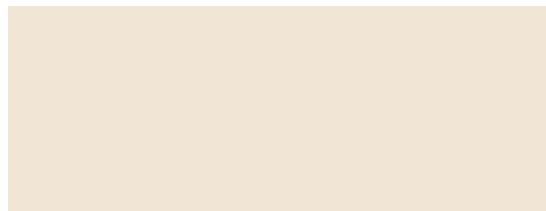

Color number 428



Color number 427



Color number 1714



Color number 2741C



Color number 669C



Color number 2654A



KMEW Co.,Ltd.

Head office: 13F, Crystal Tower Bldg.,
1-2-27 Shiromi, Chuo-ku, Osaka, Japan