

# Facade

2026 | 04 |



Products

Legerair / FLAT DESIGN PANEL / Neorock Photocatalytic Ceramic Coating /  
FilltectN Photocatalytic Ceramic Coating / FilltectE Photocatalytic Ceramic Coating /  
Excellage Photocatalytic Ceramic Coating



# Dirt is decomposed by sunlight

## Decomposition Power

Dirt is decomposed by the sun (Ultraviolet Rays), weakening adhesion.

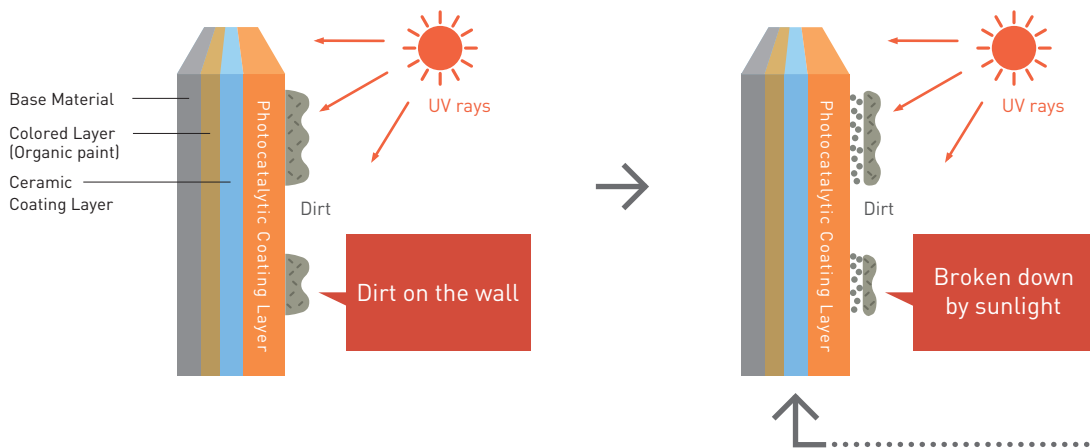

# A home that is eco-friendly

## Air-purifying Function

Photocatalytic coat decomposes pollutants in the air and exhaust gas (NOx and SOx) into clean air .

The air purification capability of Photocatalytic coat of 165m<sup>2</sup> is worth 12 poplars.

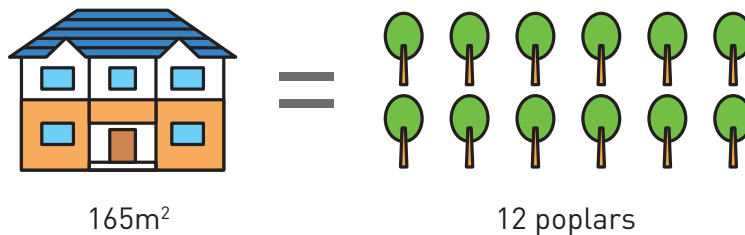

\*Assuming a poplar tree's air purifying capability (NO2) is 0.57g / day

Compatibility with water allows for easy cleaning.

## Super Hydrophilic Property

Due to the extreme compatibility with water, rainwater rinses off dirt.

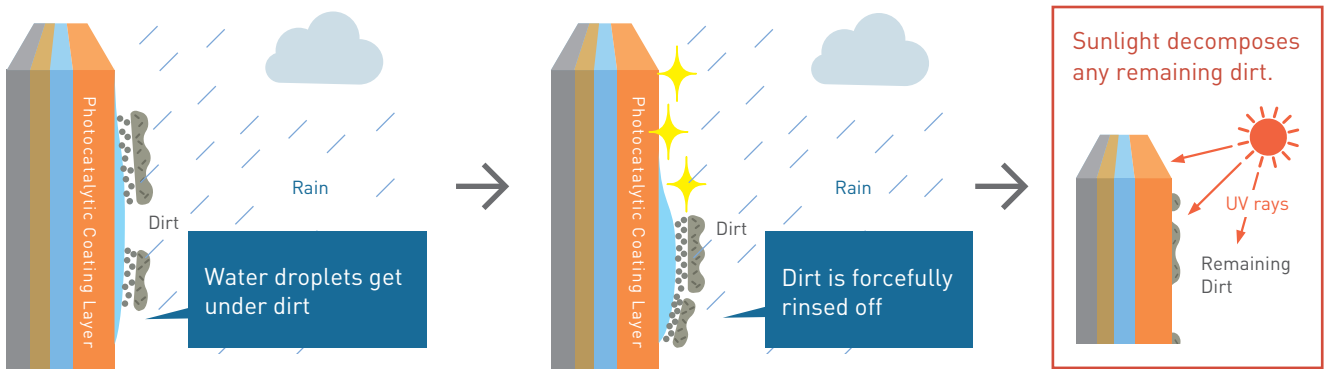

The ceramic coating layer offers strong protection against fading and sunburning

## Super Weather Resistance

The double effects of the inorganic resin and the inorganic UV absorber protects against over time and cuts UV rays.

### Point 1: Inorganic resin

The main framework is 100% inorganic with bonds that are strengthened by UV energy to prevent deterioration over time.

■ Molecular structure diagram

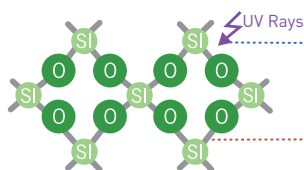

Bonds are not easily broken

Molecular Bonds

**413 KJ / mol**  
Kilo jules per mole

**443KJ / mol**

Increased strength from UV energy to prevent bonds from being easily broken

### Point 2: Inorganic UV absorber

The inorganic construction helps prevent deterioration and is able to cut UV rays.



Products

Neorock Hydrophilic coating / Excellage Hydrophilic coating /  
FilltectN Hydrophilic coating / FilltectE Hydrophilic coating /  
Ceradir Hydrophilic coating



Compatibility with water  
allows for easy cleaning.

Washed away by rainwater. Water gets on the dirt and washes the dirt away

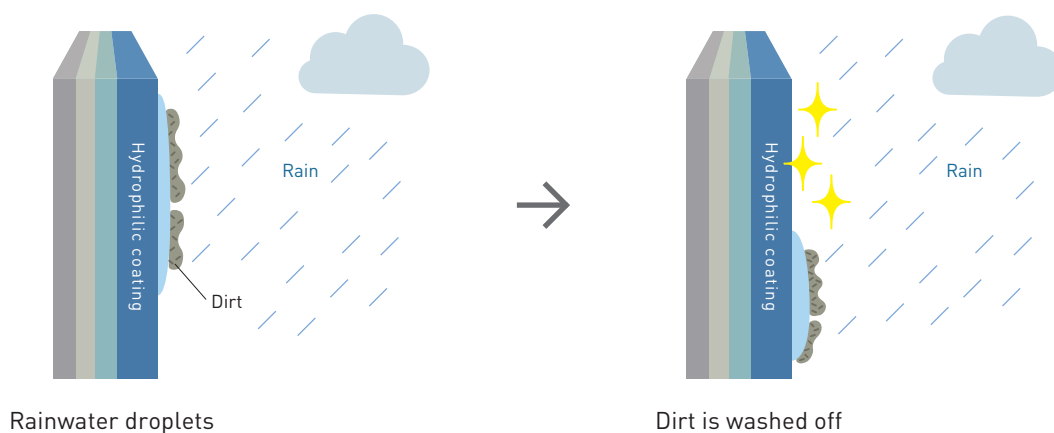

Advanced hydrophilic coating technology helps wash away dirt accumulated on the panel with rainwater. After panel being cleaned with rainwater from dirt, moisture remains on the hydrophilic surface. The color coating is strongly protected from moisture.

## Hydrophilic

The panel structure is formed from the substrate, base paint protective clear coating and hydrophilic coating.

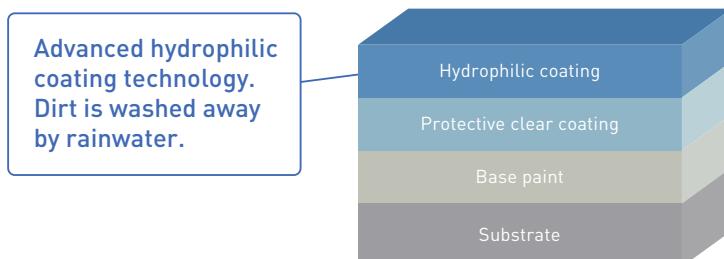





Fillect N Photocatalytic Ceramic Coating 16  
Natural Brick FT  
FH4927U

## Filltect N Photocatalytic Ceramic Coating 16

## Filltect E Photocatalytic Ceramic Coating 16

### Filltect N Photocatalytic Ceramic Coating 16 Ceratopia

Gemma FT  
 New Inplace FT  
 Barn Wood FT  
 Brulee Wood FT  
 Fierte FT  
 Board Formed Concrete FT

### Filltect N Photocatalytic Ceramic Coating 16

Ridge Wave FT  
 Accurate FT  
 New Slim Stone FT  
 Natural Brick FT  
 Ofen Brick FT  
 Tiers Tile FT  
 Drawer Tile FT  
 Sephiro Wood FT  
 Urban Cedar FT  
 Sho Sugi Ban FT  
 Smash Line FT  
 Stripe 10 FT  
 Modern Slit FT  
 Strahl FT  
 Fiotto FT  
 Scre Flat FT  
 Cast Stripe FT  
 Cashmere Smooth FT  
 Zen Garden FT  
 3 Reveal FT  
 8 Reveal FT

### Filltect E Photocatalytic Ceramic Coating 16

Stripe 8 FT  
 Flat FT

## Joint Alignment & Connection Sections

### Joint Alignment with Caulking

- To enhance the natural appearance of the design, the joint width intentionally varies.  
 In addition, the joints on both sides of the caulking may be misaligned by approximately 3mm.
- The joint width varies to create a natural design expression.
- The joints on either side of the caulking may be offset by around 3mm.

### Connection Sections

A joint is placed every approx. 455mm in the vertical direction.  
 Depending on lighting conditions, sunlight, or viewing angle, subtle shadows or slight gaps may appear along the joint lines.

## Performance List

item	unit	Filltect N Photocatalytic Ceramic Coating 16	Filltect E Photocatalytic Ceramic Coating 16	note
		16mm thickness		
specific gravity	—	1.0*	1.2*	Drying at 105°C for 24 hours
Water content	%	20 or under	20 or under	JISA5422
Water absorption rate	%	50 or under	50 or under	Water absorption 24h→105°C 24h
Bending Failure Load	N	785 or over	785 or over	JISA5422
Impact resistance	—	Passed	Passed	JISA5422

\*These are our measured values.

# Filltect N Photocatalytic Ceramic Coating 16 Ceratopia

16 mm thickness | Filltect N Photocatalytic Ceramic Coating 16 Ceratopia

16×455×3030(mm) | 11,000JPY/piece 7,980JPY/m<sup>2</sup>

Photocatalytic  
Self-  
cleaning

Weather  
resistance grade  
★★★

## Gemma FT

Installation  
Horizontal



FH7241A



FH7242A



FH7243A

## New Inplace FT

Installation  
Horizontal



FH7251A



FH7252A

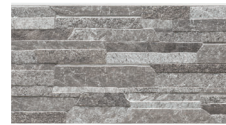

FH7253A

## Barn Wood FT

Installation  
Horizontal  
and  
Vertical



HFH7521A



HFH7522A



HFH7523A



HFH7524A



HFH7526A

## Brulee Wood FT

Installation  
Horizontal  
and  
Vertical



FH7261A

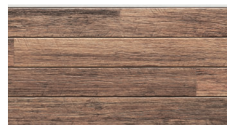

FH7263A



FH7265A

## Fierte FT

Installation  
Horizontal  
and  
Vertical



FH7272A



FH7274A

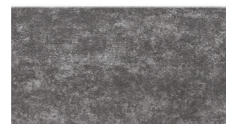

FH7275A

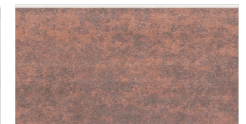

FH7276A



FH7277A

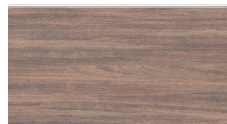

FH7278A



FH7279A

## Board Formed Concrete FT

Installation  
Horizontal  
and  
Vertical



HFH7431A



HFH7432A



HFH7433A

# Filltect N Photocatalytic Ceramic Coating 16

16 mm thickness | Filltect N Photocatalytic Ceramic Coating 16

16x455x3030(mm) | 10,300JPY/piece 7,470JPY/m<sup>2</sup>

Photocatalytic  
Self-  
cleaning

Weather  
resistance grade  
★★★

## Ridge Wave FT

Installation  
Horizontal



FH4911U



FH4913U



FH4914U

## Accurate FT

Installation  
Horizontal



FH7131U



FH7133U



FH7134U

## New Slim Stone FT

Installation  
Horizontal  
and  
Vertical



FH4865K



FH4867K



FH4868K



FH4869K

## Natural Brick FT

Installation  
Horizontal



FH4925U



FH4926U



FH4927U

## Ofen Brick FT

Installation  
Horizontal



FH7155A



FH7156A



FH7157A



FH7158A

## Tiers Tile FT

Installation  
Horizontal



FH7141A



FH7142A



FH7143A



FH7144A



FH7145A



FH7146A

## Filltect N Photocatalytic Ceramic Coating 16

16 mm thickness | Filltect N Photocatalytic Ceramic Coating 16

16×455×3030(mm) | 10,300JPY/piece 7,470JPY/m<sup>2</sup>

Photocatalytic  
Self-  
cleaning

Weather  
resistance grade  
★★★

### Drawer Tile FT

Installation  
Horizontal



FH4935U



FH4937U



FH4938U

### Sephiro Wood FT

Installation  
Horizontal  
and  
Vertical



FH4875U



FH4878U



FH4879U



FH48710U



FH48712U



FH48713U

### Urban Cedar FT

Installation  
Horizontal  
and  
Vertical



HFH7451U



HFH7452U



HFH7453U



HFH7454U



HFH7455U

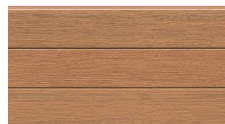

HFH7456U

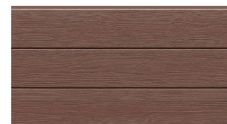

HFH7457U



HFH7458U

16×455×3030(mm) | 10,000JPY/piece 7,250JPY/m<sup>2</sup>

### Sho Sugi Ban FT

Installation  
Horizontal  
and  
Vertical



HFH5481U



HFH5491U

### Smash Line FT

Installation  
Horizontal



FH4885K



FH4886K



FH4887K



FH4888K

### Stripe 10 FT

Installation  
Horizontal  
and  
Vertical



FH7161K



FH7162K



FH7163K



FH7164K

### Modern Slit FT

Installation  
Horizontal  
and  
Vertical



### Strahl FT

Installation  
Horizontal



### Fiotto FT

Installation  
Horizontal  
and  
Vertical



### Scre Flat FT

Installation  
Horizontal  
and  
Vertical

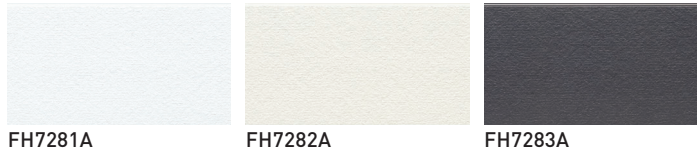

### Cast Stripe FT

Installation  
Horizontal  
and  
Vertical

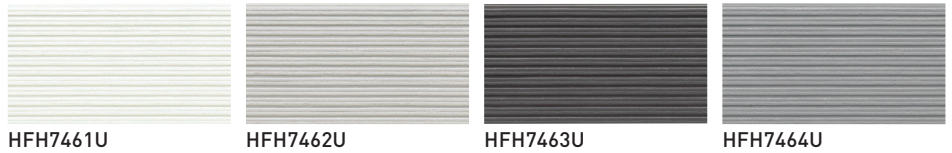

# Filltect N Photocatalytic Ceramic Coating 16

16 mm thickness | Filltect N Photocatalytic Ceramic Coating 16

16×455×3030(mm) | 10,000JPY/piece 7,250JPY/m<sup>2</sup>



## Cashmere Smooth FT



## Zen Garden FT



### 3 Reveal FT



### 8 Reveal FT



# Filltect E Photocatalytic Ceramic Coating 16

16 mm thickness | Filltect E Photocatalytic Ceramic Coating 16

16×455×3030(mm)

Optional Color : **10,600JPY**/piece 7,690JPY/m<sup>2</sup>  
 FH7501EK, FH7502EK, FH7503EK, FH7493EK, FH7494EK, FH74920EK : **10,000JPY**/piece 7,250JPY/m<sup>2</sup>



## Stripe 8 FT

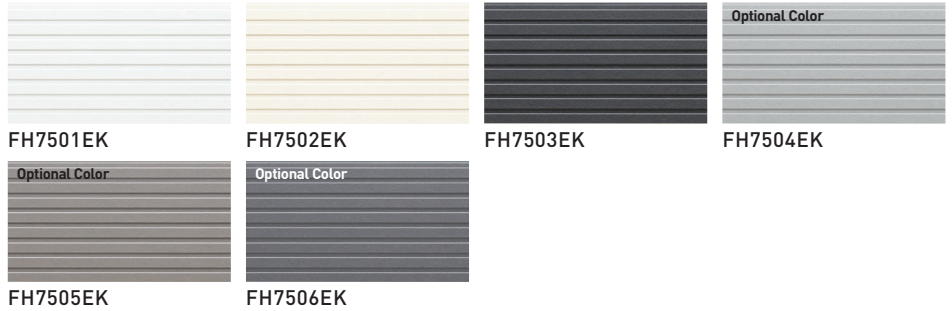

## Flat FT





# Gemma FT

Coating performance	Weather resistance	Installation
Photocatalytic Self-cleaning	Weather resistance grade ★★★	Installation Horizontal



FH7241A



FH7242A



FH7243A

## Specifications

Size	16×455(exposed width)×3030mm
Price	<b>11,000JPY</b> /piece 7,980JPY/m <sup>2</sup>
Number of panel per package	2pieces
Coverage	1.38m <sup>2</sup> /piece
Weight	Approx. 23kg/piece

## Outside corner

Outside corner l=455

16×outside:91(inside:75)  
×455(exposed width)

## Accessories list

Genuine accessories are required to install siding panels

Panel	Accessories	Outside corner l=455	Caulking (Holder set: B80E)	Repair Paint	
FH7241A		FHD7241A	B8430978	B97F2985AA	—
FH7242A		FHD7242A	B8430979	—	B98F2986AA
FH7243A		FHD7243A	B84301847	B97F2987AA	—
Price		<b>4,800JPY</b> /piece	<b>6,600JPY</b> /piece	<b>13,100JPY</b> /box	<b>13,600JPY</b> /box
Number of panel per package	10 pieces/box (Ordering Unit 1piece)	10 pieces/box*1 (Ordering Unit 1piece)		1 set/box	
		Caulking(600ml)10pieces, Primer,brush,nozzle2pieces *Holder set are sold separately		Inorganic ever-drying type Paint Base(10g)2 kinds each,Hardener(7g)2pieces, Primer(7.5g)1piece, brush3pieces,felt stick2pieces	
				Inorganic ever-drying type Paint Base(10g)5 kinds each,Hardener(7g)3pieces, Primer(7.5g)1piece, brush4pieces,felt stick3pieces	

\*1 The dedicated primer (part number B85AA or B85BB) will be shipped at the same time.

# New Inplace FT

Coating performance	Weather resistance	Installation
Photocatalytic Self-cleaning	Weather resistance grade ★★★	Installation Horizontal



FH7251A



FH7252A

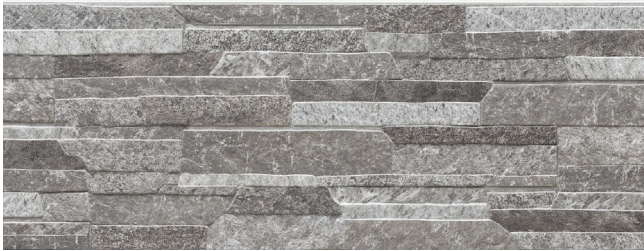

FH7253A

## Specifications

Size	16×455(exposed width)×3030mm
Price	<b>11,000 JPY</b> /piece 7,980 JPY/m <sup>2</sup>
Number of panel per package	2pieces
Coverage	1.38m <sup>2</sup> /piece
Weight	Approx. 24kg/piece

## Outside corner

Outside corner l=455

16×outside:91(inside:75)  
×455(exposed width)

## Accessories list

Genuine accessories are required to install siding panels

Panel	Accessories	Outside corner l=455	Caulking (Holder set: B80E)	Repair Paint
FH7251A		FHD7251A	B84302999	B97F2999AA
FH7252A		FHD7252A	B84304013	B97F3800AA
FH7253A		FHD7253A	B84301843	B97F3801AA
Price		<b>4,800 JPY</b> /piece	<b>6,600 JPY</b> /piece	<b>13,100 JPY</b> /box
Number of panel per package		10 pieces/box (Ordering Unit 1 piece)	10 pieces/box <sup>*</sup> (Ordering Unit 1 piece) Caulking(600ml)10pieces, Primer,brush,nozzle2pieces <small>*Holder set are sold separately</small>	1 set/box <small>Inorganic ever-drying type Paint Base(10g)12 kinds each,Hardener(7g)2pieces, Primer(7.5g)1piece, brush3pieces,felt stick2pieces</small>

\*1 The dedicated primer (part number B85AA or B85BB) will be shipped at the same time.

# Barn Wood FT

Coating performance	Weather resistance	Installation
Photocatalytic Self-cleaning	Weather resistance grade ★★★	Installation Horizontal and Vertical



HFH7521A



HFH7522A



HFH7523A



HFH7524A



HFH7526A

## Specifications

Size	16×455(exposed width)×3030mm
Price	<b>11,000JPY/piece</b> 7,980JPY/m <sup>2</sup>
Number of panel per package	2pieces
Coverage	1.38m <sup>2</sup> /piece
Weight	Approx. 25kg/piece

## Outside corner

Outside corner l=455	Outside corner l=3030
16×outside:91(inside:75)×455(exposed width)	16×outside:91(inside:75)×3030

## Accessories list

Genuine accessories are required to install siding panels

Panel	Accessories		Through Wall Flashing l=3030	Caulking (Holder set: B80E)	Repair Paint	
	Outside corner l=455	Outside corner l=3030				
HFH7521A	HFHD7521A	HFHL7521A	B2241557	B84302980	B97F2980AA	—
HFH7522A	HFHD7522A	HFHL7522A	B22413113	B84302831	B97F2981AA	—
HFH7523A	HFHD7523A	HFHL7523A	B2241W3	B84302982	B97F2982AA	—
HFH7524A	HFHD7524A	HFHL7524A	B2241441	B84302864	—	B98F2983AA
HFH7526A	HFHD7526A	HFHL7526A	B2241460	B84304099	—	B98F4099AA
Price	<b>4,800JPY/piece</b>	<b>21,500JPY/piece</b>	<b>3,200JPY/piece</b>	<b>6,600JPY/piece</b>	<b>13,100JPY/box</b>	<b>13,600JPY/box</b>
Number of panel per package	10 pieces/box (Ordering Unit 1piece)	1piece	5 pieces/box	10 pieces/box <sup>*1</sup> (Ordering Unit 1piece)	1 set/box	1 set/box
				Caulking(600ml)10pieces, Primer,brush,nozzle2pieces	Inorganic ever-drying type Paint Base(10g)2 kinds each, Hardener(7g)2pieces, Primer(7.5g)1piece, brush3pieces,felt stick2pieces	Inorganic ever-drying type Paint Base(10g)3 kinds each, Hardener(7g)3pieces, Primer(7.5g)1piece, brush4pieces,felt stick3pieces

\*1 The dedicated primer (part number B85AA or B85BB) will be shipped at the same time.

# Brulee Wood FT

<b>Coating performance</b> Photocatalytic Self-cleaning	<b>Weather resistance</b> Weather resistance grade ★★	<b>Installation</b> Installation Horizontal and Vertical
--	--	---



FH7261A



FH7263A



FH7265A

## Specifications

Size	16×455(exposed width)×3030mm
Price	<b>11,000JPY/piece</b> 7,980JPY/m <sup>2</sup>
Number of panel per package	2pieces
Coverage	1.38m <sup>2</sup> /piece
Weight	Approx. 25kg/piece

## Outside corner

Outside corner l=455

16×outside:91(inside:75) ×455(exposed width)

Outside corner l=3030

16×outside:91(inside:75) ×3030

Shiplap corner

Vertical installation with clips

## Accessories list

Genuine accessories are required to install siding panels

Panel	Accessories					
	Outside corner l=455	Outside corner l=3030	Through Wall Flashing l=3030	Caulking (Holder set: B80E)	Repair Paint	
FH7261A	FHD7261A	FHP7261A	B2241557	B84302955	B97F2955AA	—
FH7263A	FHD7263A	FHP7263A	B22412606	B84302956A	B97F2956AA	—
FH7265A	FHD7265A	FHP7265A	B22413114	B84302415	—	B98F3953AA
Price	<b>4,800JPY/piece</b>	<b>21,500JPY/piece</b>	<b>3,200JPY/piece</b>	<b>6,600JPY/piece</b>	<b>13,100JPY/box</b>	<b>13,600JPY/box</b>
Number of panel per package	10 pieces/box (Ordering Unit 1piece)	1piece	5 pieces/box	10 pieces/box <sup>*)</sup> (Ordering Unit 1piece) Caulking(600ml)10pieces, Primer,brush,nozzle2pieces <small>*Holder set are sold separately</small>	1 set/box Inorganic ever-drying type Paint Base(10g)2 kinds each, Hardener(7g)2pieces, Primer(7.5g)1piece, brush3pieces,felt stick2pieces	1 set/box Inorganic ever-drying type Paint Base(10g)3 kinds each, Hardener(7g)3pieces, Primer(7.5g)1piece, brush4pieces,felt stick3pieces

\*1 The dedicated primer (part number B85AA or B85BB) will be shipped at the same time.

# Fierte FT

<b>Coating performance</b>	<b>Weather resistance</b>	<b>Installation</b>
Photocatalytic Self-cleaning	Weather resistance grade ★★★	Installation Horizontal and Vertical



FH7272A



FH7274A

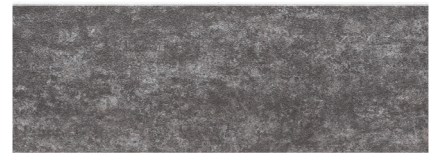

FH7275A



FH7276A



FH7277A



FH7278A



FH7279A

## Specifications

Size	16×455(exposed width)×3030mm
Price	<b>11,000JPY/piece</b> 7,980JPY/m <sup>2</sup>
Number of panel per package	2pieces
Coverage	1.38m <sup>2</sup> /piece
Weight	Approx. 24kg/piece

## Outside corner

Outside corner l=455

16×outside:91(inside:75) ×455(exposed width)

Outside corner l=3030

16×outside:91(inside:75) ×3030

Shiplap corner  
Vertical installation with clips

## Accessories list

Genuine accessories are required to install siding panels

Accessories	Outside corner l=455	Outside corner l=3030	Through Wall Flashing l=3030	Caulking (Holder set: B80E)	Repair Paint	
Panel						
FH7272A	FHD7272A	FHP7272A	B2241557	B84303887	B96F3887AA	—
FH7274A	FHD7274A	FHP7274A	B2241550	B84303891	B96F3891AA	—
FH7275A	FHD7275A	FHP7275A	B2241549	B84303892	—	B97F3892AA
FH7276A	FHD7276A	FHP7276A	B2241476	B84303939	—	B97F3939AA
FH7277A	FHD7277A	FHP7277A	B2241512	B84303937	B96F3937AA	—
FH7278A	FHD7278A	FHP7278A	B22413113	B8430442	—	B97F3938AA
FH7279A	FHD7279A	FHP7279A	B2241557	B84302949	—	B97F3988AA
Price	<b>4,800JPY/piece</b>	<b>21,500JPY/piece</b>	<b>3,200JPY/piece</b>	<b>6,600JPY/piece</b>	<b>6,600JPY/box</b>	<b>13,100JPY/box</b>
Number of panel per package	10 pieces/box (Ordering Unit 1piece)	1piece	5 pieces/box	10 pieces/box*1 (Ordering Unit 1piece) Caulking(600ml)10pieces, Primer,brush,nozzle2pieces *Holder set are sold separately	1 set/box Inorganic ever-drying type Paint Base(10g)1piece, Hardener(7g)1piece, Primer(7.5g)1piece, brush2pieces,felt stick1piece	1 set/box Inorganic ever-drying type Paint Base(10g)2 kinds each, Hardener(7g)2pieces, Primer(7.5g)1piece, brush3pieces,felt stick2pieces

\*1 The dedicated primer (part number B85AA or B85BB) will be shipped at the same time.

# Board Formed Concrete FT

<b>Coating performance</b>	<b>Weather resistance</b>	<b>Installation</b>
Photocatalytic Self-cleaning	Weather resistance grade ★★★	Installation Horizontal and Vertical



HFH7431A



HFH7432A





HFH7433A

## Specifications

Size	16×455(exposed width)×3030mm
Price	<b>11,000JPY</b> /piece 7,980JPY/m <sup>2</sup>
Number of panel per package	2pieces
Coverage	1.38m <sup>2</sup> /piece
Weight	Approx. 26kg/piece

## Outside corner

Outside corner l=455  16×outside:91(inside:75) ×455(exposed width)	Outside corner l=3030  16×outside:91(inside:75) ×3030
---	--

## Accessories list

Genuine accessories are required to install siding panels

Accessories	Outside corner l=455	Outside corner l=3030	Through Wall Flashing l=3030	Caulking (Holder set: B80E)	Repair Paint
Panel					
HFH7431A	HFHD7431A	HFHL7431A	RE224557	B84302879	B97F3823AA
HFH7432A	HFHD7432A	HFHL7432A	RE224557	B84302880	B97F3824AA
HFH7433A	HFHD7433A	HFHL7433A	B224550	B84301823	B97F3825AA
Price	<b>4,800JPY</b> /piece	<b>21,500JPY</b> /piece	<b>3,200JPY</b> /piece	<b>6,600JPY</b> /piece	<b>13,100JPY</b> /box
Number of panel per package	10 pieces/box (Ordering Unit 1piece)	1piece	5 pieces/box	10 pieces/box* <sup>1</sup> (Ordering Unit 1piece) Caulking(600ml)10pieces, Primer,brush,nozzle2pieces *Holder set are sold separately	1 set/box Inorganic ever-drying type Paint Base(10g)2 kinds each, Hardener(7g)2pieces, Primer(7.5g)1piece, brush3pieces,felt stick2pieces

\*1 The dedicated primer (part number B85AA or B85BB) will be shipped at the same time.

# Ridge Wave FT

Coating performance	Weather resistance	Installation
Photocatalytic Self-cleaning	Weather resistance grade ★★★	Installation Horizontal



FH4911U



FH4913U



FH4914U

## Specifications

Size	16×455(exposed width)×3030mm
Price	<b>10,300JPY</b> /piece 7,470JPY/m <sup>2</sup>
Number of panel per package	2pieces
Coverage	1.38m <sup>2</sup> /piece
Weight	Approx. 24kg/piece

## Outside corner

Outside corner l=455

16×outside:91(inside:75)  
×455(exposed width)

## Accessories list

Genuine accessories are required to install siding panels

Panel	Accessories	Outside corner l=455	Caulking (Holder set: B80E)	Repair Paint	
FH4911U		FHD4911U	B84303859	—	B98L3859AU
FH4913U		FHD4913U	B8430409	—	B98L3861AU
FH4914U		FHD4914U	B84303045	B97L3862AU	—
Price		<b>4,400JPY</b> /piece	<b>6,600JPY</b> /piece	<b>13,100JPY</b> /box	<b>13,600JPY</b> /box
Number of panel per package	10 pieces/box (Ordering Unit 1piece)	10 pieces/box*1 (Ordering Unit 1piece)	Caulking(600ml)10pieces, Primer,brush,nozzle2pieces	1 set/box	1 set/box
				Inorganic ever-drying type Paint Base(10g)2 kinds each, Hardener(7g)2pieces, Primer(7.5g)1piece,brush3pieces	Inorganic ever-drying type Paint Base(10g)3 kinds each, Hardener(7g)3pieces, Primer(7.5g)1piece,brush4pieces

\*1 The dedicated primer (part number B85AA or B85BB) will be shipped at the same time.

# Accurate FT

Coating performance	Weather resistance	Installation
Photocatalytic Self-cleaning	Weather resistance grade ★★★	Installation Horizontal



FH7131U



FH7133U



FH7134U

## Specifications

Size	16×455(exposed width)×3030mm
Price	<b>10,300 JPY</b> /piece 7,470 JPY/m <sup>2</sup>
Number of panel per package	2pieces
Coverage	1.38m <sup>2</sup> /piece
Weight	Approx. 25kg/piece

## Outside corner



## Accessories list

Genuine accessories are required to install siding panels

Panel	Accessories	Outside corner l=455	Caulking (Holder set: B80E)	Repair Paint
FH7131U		FHD7131U	B84302491C	B97L3910AU
FH7133U		FHD7133U	B84303045	B97L3912AU
FH7134U		FHD7134U	B84303045	B97L3913AU
Price		<b>4,400 JPY</b> /piece	<b>6,600 JPY</b> /piece	<b>13,100 JPY</b> /box
Number of panel per package		10 pieces/box (Ordering Unit 1piece)	10 pieces/box*1 (Ordering Unit 1piece) Caulking(600ml)10pieces, Primer,brush,nozzle2pieces *Holder set are sold separately	1 set/box Inorganic ever-drying type Paint Base(10g)2 kinds each, Hardener(7g)2pieces, Primer(7.5g)1piece,brush3pieces

\*1 The dedicated primer (part number B85AA or B85BB) will be shipped at the same time.

# New Slim Stone FT

<b>Coating performance</b>	<b>Weather resistance</b>	<b>Installation</b>
Photocatalytic Self-cleaning	Weather resistance grade ★★	Installation Horizontal and Vertical



FH4865K



FH4867K



FH4868K



FH4869K

## Specifications

Size	16×455(exposed width)×3030mm
Price	<b>10,300 JPY/piece</b> 7,470JPY/m <sup>2</sup>
Number of panel per package	2pieces
Coverage	1.38m <sup>2</sup> /piece
Weight	Approx. 24kg/piece

## Outside corner

Outside corner l=455

16×outside:91(inside:75) ×455(exposed width)

Outside corner l=3030

16×outside:91(inside:75) ×3030

Shiplap corner

Vertical installation with clips

## Accessories list

Genuine accessories are required to install siding panels

Panel	Accessories		Through Wall Flashing l=3030	Caulking (Holder set: B80E)	Repair Paint	
	Outside corner l=455	Outside corner l=3030				
FH4865K	FHD4865K	FHP4865K	B2241W2	B84301944	B96L2531EU	—
FH4867K	FHD4867K	FHP4867K	B2241W4	B84301937	—	B97L1937BU
FH4868K	FHD4868K	FHP4868K	B2241550	B84301935A	—	B97L1935BU
FH4869K	FHD4869K	FHP4869K	B22413114	B84303840	—	B97L3840AU
Price	<b>4,400 JPY/piece</b>	<b>19,800 JPY/piece</b>	<b>3,200 JPY/piece</b>	<b>6,600 JPY/piece</b>	<b>6,600 JPY/box</b>	<b>13,100 JPY/box</b>
Number of panel per package	10 pieces/box (Ordering Unit 1piece)	1piece	5 pieces/box	10 pieces/box* (Ordering Unit 1piece) Caulking(600ml)10pieces, Primer,brush,nozzle2pieces *Holder set are sold separately	1 set/box Inorganic ever-drying type Paint Base(10g)1piece, Hardener(7g)1piece, Primer(7.5g)1piece,brush2pieces	1 set/box Inorganic ever-drying type Paint Base(10g)2 kinds each, Hardener(7g)2pieces, Primer(7.5g)1piece,brush3pieces

\*1 The dedicated primer (part number B85AA or B85BB) will be shipped at the same time.

# Natural Brick FT

Coating performance	Weather resistance	Installation
Photocatalytic Self-cleaning	Weather resistance grade ★★	Installation Horizontal



FH4925U



FH4926U



FH4927U

## Specifications

Size	16×455(exposed width)×3030mm
Price	<b>10,300JPY/piece</b> 7,470JPY/m <sup>2</sup>
Number of panel per package	2pieces
Coverage	1.38m <sup>2</sup> /piece
Weight	Approx. 25kg/piece

## Outside corner

Outside corner l=455

16×outside:91(inside:75)  
×455(exposed width)

## Accessories list

Genuine accessories are required to install siding panels

Panel	Accessories	Outside corner l=455	Caulking (Holder set: B80E)	Repair Paint	
FH4925U		FHD4925U	B84302491A	B97L3959AU	—
FH4926U		FHD4926U	B8430746	—	B98L3960AU
FH4927U		FHD4927U	B8430427	—	B98L3961AU
Price		4,400JPY/piece	6,600JPY/piece	13,100JPY/box	13,600JPY/box
Number of panel per package		10 pieces/box (Ordering Unit 1piece)	10 pieces/box*1 (Ordering Unit 1piece) Caulking(600ml)10pieces, Primer,brush,nozzle2pieces *Holder set are sold separately	1 set/box Inorganic ever-drying type Paint Base(10g)2 kinds each, Hardener(7g)2pieces, Primer(7.5g)1piece,brush3pieces	1 set/box Inorganic ever-drying type Paint Base(10g)3 kinds each, Hardener(7g)3pieces, Primer(7.5g)1piece,brush4pieces

\*1 The dedicated primer (part number B85AA or B85BB) will be shipped at the same time.

# Ofen Brick FT

Coating performance	Weather resistance	Installation
Photocatalytic Self-cleaning	Weather resistance grade ★★★	Installation Horizontal



FH7155A



FH7156A

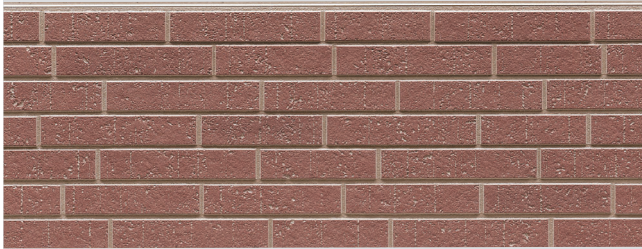

FH7157A



FH7158A

## Specifications

Size	16×455(exposed width)×3030mm
Price	<b>10,300 JPY</b> /piece 7,470 JPY/m <sup>2</sup>
Number of panel per package	2pieces
Coverage	1.38m <sup>2</sup> /piece
Weight	Approx. 25kg/piece

## Outside corner



## Accessories list

Genuine accessories are required to install siding panels

Panel	Accessories	Outside corner l=455	Caulking (Holder set: B80E)	Repair Paint
FH7155A		FHD7155A	B84304047	B97L4083AA
FH7156A		FHD7156A	B84301843	B97L4049AA
FH7157A		FHD7157A	B8430409B	B97L4084AA
FH7158A		FHD7158A	B84301843	B97L4048AA
Price		<b>4,400 JPY</b> /piece	<b>6,600 JPY</b> /piece	<b>13,100 JPY</b> /box
Number of panel per package		10 pieces/box (Ordering Unit 1piece)	10 pieces/box*1 (Ordering Unit 1piece) Caulking(600ml)10pieces, Primer,brush, nozzle2pieces *Holder set are sold separately	1 set/box Inorganic ever-drying type Paint Base(10g)2 kinds each, Hardener(7g)2pieces, Primer(7.5g)1piece,brush3pieces

\*1 The dedicated primer (part number B85AA or B85BB) will be shipped at the same time.

# Tiers Tile FT

Coating performance	Weather resistance	Installation
Photocatalytic Self-cleaning	Weather resistance grade ★★★	Installation Horizontal



FH7141A



FH7142A



FH7143A



FH7144A



FH7145A



FH7146A

## Specifications

Size	16×455(exposed width)×3030mm
Price	<b>10,300JPY/piece</b> 7,470JPY/m <sup>2</sup>
Number of panel per package	2pieces
Coverage	1.38m <sup>2</sup> /piece
Weight	Approx. 24kg/piece

## Outside corner



## Accessories list

Genuine accessories are required to install siding panels

Panel	Accessories			
	Outside corner l=455	Caulking (Holder set: B80E)	Repair Paint	
FH7141A	FHD7141A	B84301843	—	B97L3928AA
FH7142A	FHD7142A	B84301843	—	B97L3929AA
FH7143A	FHD7143A	B84302417	B96L3246AA	—
FH7144A	FHD7144A	B84303045	—	B97L3931AA
FH7145A	FHD7145A	B84304047	—	B97L4083AA
FH7146A	FHD7146A	B84301843	—	B97L4048AA
Price	4,400JPY/piece	6,600JPY/piece	6,600JPY/box	13,100JPY/box
Number of panel per package	10 pieces/box (Ordering Unit 1piece)	10 pieces/box*1 (Ordering Unit 1piece)	1 set/box	1 set/box
		Caulking(600ml)10pieces, Primer,brush,nozzle2pieces *Holder set are sold separately	Inorganic ever-drying type Paint Base(10g)1piece, Hardener(7g)1piece, Primer(7.5g)1piece,brush2pieces	Inorganic ever-drying type Paint Base(10g)2 kinds each, Hardener(7g)2pieces, Primer(7.5g)1piece,brush3pieces

\*1 The dedicated primer (part number B85AA or B85BB) will be shipped at the same time.

# Drawer Tile FT

Coating performance	Weather resistance	Installation
Photocatalytic Self-cleaning	Weather resistance grade ★★★	Installation Horizontal



FH4935U



FH4937U



FH4938U

## Specifications

Size	16×455(exposed width)×3030mm
Price	<b>10,300JPY</b> /piece 7,470JPY/m <sup>2</sup>
Number of panel per package	2pieces
Coverage	1.38m <sup>2</sup> /piece
Weight	Approx. 25kg/piece

## Outside corner

Outside corner l=455

16×outside:91(inside:75)  
×455(exposed width)

## Accessories list

Genuine accessories are required to install siding panels

Panel	Accessories	Outside corner l=455	Caulking (Holder set: B80E)	Repair Paint	
FH4935U		FHD4935U	B84303963	B97L3963AU	—
FH4937U		FHD4937U	B84302417B	—	B98L3965AU
FH4938U		FHD4938U	B8430713	B97L3966AU	—
Price		<b>4,400JPY</b> /piece	<b>6,600JPY</b> /piece	<b>13,100JPY</b> /box	<b>13,600JPY</b> /box
Number of panel per package		10 pieces/box (Ordering Unit 1piece)	10 pieces/box* (Ordering Unit 1piece) Caulking(600ml)10pieces, Primer,brush,nozzle2pieces *Holder set are sold separately	1 set/box Inorganic ever-drying type Paint Base(10g)2 kinds each, Hardener(7g)2pieces, Primer(7.5g)1piece,brush3pieces	1 set/box Inorganic ever-drying type Paint Base(10g)3 kinds each, Hardener(7g)3pieces, Primer(7.5g)1piece,brush4pieces

\*1 The dedicated primer (part number B85AA or B85BB) will be shipped at the same time.

# Sephiro Wood FT

Coating performance	Weather resistance	Installation
Photocatalytic Self-cleaning	Weather resistance grade ★★★	Installation Horizontal and Vertical



FH4875U



FH4878U



FH4879U



FH48710U



FH48712U



FH48713U

## Specifications

Size	16×455(exposed width)×3030mm
Price	<b>10,300 JPY/piece</b> 7,470JPY/m <sup>2</sup>
Number of panel per package	2pieces
Coverage	1.38m <sup>2</sup> /piece
Weight	Approx. 24kg/piece

## Outside corner

Outside corner l=455      Outside corner l=3030

Shiplap corner  
Vertical installation with clips

16×outside:91(inside:75) ×455(exposed width)      16×outside:91(inside:75) ×3030

## Accessories list

Genuine accessories are required to install siding panels

Panel	Outside corner l=455	Outside corner l=3030	Through Wall Flashing l=3030	Caulking (Holder set: B80E)	Repair Paint
FH4875U	FHD4875U	FHP4875U	B2241476	B84302833	B972833CU
FH4878U	FHD4878U	FHP4878U	B2241W3	B84302836	B972836CU
FH4879U	FHD4879U	FHP4879U	B22412606	B84302920	B972920AU
FH48710U	FHD48710U	FHP48710U	B2241W2	B8430495	B973946AU
FH48712U	FHD48712U	FHP48712U	B2241W1	B8430709	B962931BU
FH48713U	FHD48713U	FHP48713U	B2241W4	B84302636A	B974059AU
Price	<b>4,400 JPY/piece</b>	<b>19,800 JPY/piece</b>	<b>3,200 JPY/piece</b>	<b>6,600 JPY/piece</b>	<b>13,100 JPY/box</b>
Number of panel per package	10 pieces/box (Ordering Unit 1piece)	1piece	5 pieces/box	10 pieces/box* (Ordering Unit 1piece) Caulking(600ml)10pieces, Primer,brush,nozzle2pieces *Holder set are sold separately	1 set/box Inorganic ever-drying type Paint Base(9g)2 kinds each, Hardener(7g)2pieces, Primer(7.5g)1piece,brush3pieces

\*1 The dedicated primer (part number B85AA or B85BB) will be shipped at the same time.

# Urban Cedar FT

Coating performance	Weather resistance	Installation
Photocatalytic Self-cleaning	Weather resistance grade ★★★	Installation Horizontal and Vertical



HFH7451U



HFH7452U



HFH7453U



HFH7454U



HFH7455U



HFH7456U



HFH7457U





HFH7458U

## Specifications

Size	16×455(exposed width)×3030mm
Price	<b>10,300 JPY/piece</b> 7,470JPY/m <sup>2</sup>
Number of panel per package	2pieces
Coverage	1.38m <sup>2</sup> /piece
Weight	Approx. 25kg/piece

## Outside corner

Outside corner l=455  16×outside:91(inside:75) ×455(exposed width)	Outside corner l=3030  16×outside:91(inside:75) ×3030
--	---

## Accessories list

Genuine accessories are required to install siding panels

Panel	Accessories		Repair Paint		
	Outside corner l=455	Outside corner l=3030			
HFH7451U	HFHD7451U	HFHL7451U	—	B97L3954AU	—
HFH7452U	HFHD7452U	HFHL7452U	—	—	B98L3955AU
HFH7453U	HFHD7453U	HFHL7453U	—	B97L3956AU	—
HFH7454U	HFHD7454U	HFHL7454U	—	—	B98L3927AU
HFH7455U	HFHD7455U	HFHL7455U	—	—	B98L3958AU
HFH7456U	HFHD7456U	HFHL7456U	—	B97L4130AU	
HFH7457U	HFHD7457U	HFHL7457U	B96L4131AU		
HFH7458U	HFHD7458U	HFHL7458U	B96L4132AU		
Price	4,400JPY/piece	19,800JPY/piece	6,600JPY/box	13,100JPY/box	13,600JPY/box
Number of panel per package	10 pieces/box (Ordering Unit 1piece)	1piece	1 set/box Inorganic ever-drying type Paint Base(10g)1piece, Hardener(7g)1piece, Primer(7.5g)1piece,brush2pieces	1 set/box Inorganic ever-drying type Paint Base(10g)2 kinds each, Hardener(7g)2pieces, Primer(7.5g)1piece,brush3pieces	1 set/box Inorganic ever-drying type Paint Base(10g)3 kinds each, Hardener(7g)3pieces, Primer(7.5g)1piece,brush4pieces

# Sho Sugi Ban FT

<b>Coating performance</b>	<b>Weather resistance</b>	<b>Installation</b>
Photocatalytic Self-cleaning	Weather resistance grade ★★★	Installation Horizontal and Vertical



HFH5481U



HFH5491U

## Specifications

Size	16×455(exposed width)×3030mm
Price	<b>10,000JPY</b> /piece 7,250JPY/m <sup>2</sup>
Number of panel per package	2pieces
Coverage	1.38m <sup>2</sup> /piece
Weight	Approx. 24kg/piece

## Outside corner

Outside corner l=455      Outside corner l=3030      Shiplap corner

Vertical installation with clips

16×outside:91(inside:75) ×455(exposed width)      16×outside:91(inside:75) ×3030

## Accessories list

Genuine accessories are required to install siding panels

Panel	Outside corner l=455	Outside corner l=3030	Through Wall Flashing l=3030	Caulking (Holder set: B80E)	Repair Paint
HFH5481U	HFHD5481U	HFHL5481U	B2241W1	B84303045	B96L3222AU
HFH5491U	HFHD5491U	HFHL5491U	B2241W1	B84303045	B96L3222AU
Price	<b>4,400JPY</b> /piece	<b>19,800JPY</b> /piece	<b>3,200JPY</b> /piece	<b>6,600JPY</b> /piece	<b>6,600JPY</b> /box
Number of panel per package	10 pieces/box (Ordering Unit 1piece)	1piece	5 pieces/box	10 pieces/box*1 (Ordering Unit 1piece) Caulking(600ml)10pieces, Primer,brush,nozzle2pieces *Holder set are sold separately	1 set/box Inorganic ever-drying type Paint Base(10g)1piece, Hardener(7g)1piece, Primer(7.5g)1piece,brush2pieces

\*1 The dedicated primer (part number B85AA or B85BB) will be shipped at the same time.

# Smash Line FT

Coating performance	Weather resistance	Installation
Photocatalytic Self-cleaning	Weather resistance grade ★★★	Installation Horizontal



FH4885K



FH4886K



FH4887K



FH4888K

## Specifications

Size	16×455(exposed width)×3030mm
Price	<b>10,000 JPY</b> /piece 7,250 JPY/m <sup>2</sup>
Number of panel per package	2pieces
Coverage	1.38m <sup>2</sup> /piece
Weight	Approx. 25kg/piece

## Outside corner



## Accessories list

Genuine accessories are required to install siding panels

Panel	Accessories	Outside corner l=455	Caulking (Holder set: B80E)	Repair Paint
FH4885K		FHD4885K	B84303044	B96L3167AK
FH4886K		FHD4886K	B84302491C	B96L2531CU
FH4887K		FHD4887K	B84301758A	B96L3166AK
FH4888K		FHD4888K	B84303045	B96L3224AK
Price		<b>4,400 JPY</b> /piece	<b>6,600 JPY</b> /piece	<b>6,600 JPY</b> /box
Number of panel per package		10 pieces/box (Ordering Unit 1piece)	10 pieces/box <sup>*1</sup> (Ordering Unit 1piece) Caulking(600ml)10pieces, Primer,brush,nozzle2pieces <small>*Holder set are sold separately</small>	1 set/box Inorganic ever-drying type Paint Base(10g)1piece, Hardener(7g)1piece, Primer(7.5g)1piece,brush2pieces

\*1 The dedicated primer (part number B85AA or B85BB) will be shipped at the same time.

# Stripe 10 FT

<b>Coating performance</b>	<b>Weather resistance</b>	<b>Installation</b>
Photocatalytic Self-cleaning	Weather resistance grade ★★★	Installation Horizontal and Vertical



FH7161K



FH7162K



FH7163K



FH7164K

## Specifications

Size	16×455(exposed width)×3030mm
Price	<b>10,000 JPY/piece</b> 7,250JPY/m <sup>2</sup>
Number of panel per package	2pieces
Coverage	1.38m <sup>2</sup> /piece
Weight	Approx. 24kg/piece

## Outside corner

Outside corner l=455      Outside corner l=3030

Shiplap corner  
Vertical installation with clips

16×outside:91(inside:75) ×455(exposed width)      16×outside:91(inside:75) ×3030

## Accessories list

Genuine accessories are required to install siding panels

Accessories	Outside corner l=455	Outside corner l=3030	Through Wall Flashing l=3030	Caulking (Holder set: B80E)	Repair Paint
Panel					
FH7161K	FHD7161K	FHP7161K	B2241W2	B84302491C	B96L3160AK
FH7162K	FHD7162K	FHP7162K	B2241549	B84303212	B96L3212AU
FH7163K	FHD7163K	FHP7163K	B2241462	B84301758A	B96L3166AK
FH7164K	FHD7164K	FHP7164K	B2241W3	B8430713	B96L3152AK
Price	<b>4,400 JPY/piece</b>	<b>19,800 JPY/piece</b>	<b>3,200 JPY/piece</b>	<b>6,600 JPY/piece</b>	<b>6,600 JPY/box</b>
Number of panel per package	10 pieces/box (Ordering Unit 1piece)	1piece	5 pieces/box	10 pieces/box* <sup>1</sup> (Ordering Unit 1piece) Caulking(600ml)10pieces, Primer,brush,nozzle2pieces *Holder set are sold separately	1 set/box Inorganic ever-drying type Paint Base(10g)1piece, Hardener(7g)1piece, Primer(7.5g)1piece,brush2pieces

\*1 The dedicated primer (part number B85AA or B85BB) will be shipped at the same time.

# Modern Slit FT

Coating performance	Weather resistance	Installation
Photocatalytic Self-cleaning	Weather resistance grade ★★	Installation Horizontal and Vertical



## Specifications

Size	16×455(exposed width)×3030mm
Price	<b>10,000JPY</b> /piece 7,250JPY/m <sup>2</sup>
Number of panel per package	2pieces
Coverage	1.38m <sup>2</sup> /piece
Weight	Approx. 25kg/piece

## Outside corner

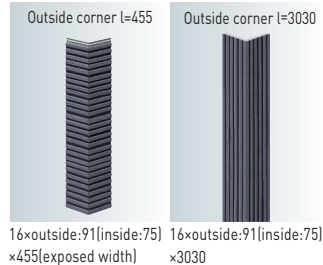

## Accessories list

Genuine accessories are required to install siding panels

Panel	Accessories	Outside corner l=455	Outside corner l=3030	Repair Paint
HFH9181U		HFHD9181U	HFHL9181U	B963051AU
HFH9182U		HFH9182U	HFHL9182U	B962540BU
HFH9183U		HFHD9183U	HFHL9183U	B962531BU
HFH9184U		HFHD9184U	HFHL9184U	B963444AU
HFH9185U		HFHD9185U	HFHL9185U	B963445AU
HFH9186U		HFH9186U	HFHL9186U	B963446AU
HFH9187U		HFH9187U	HFHL9187U	B963447AU
HFH9188U		HFHD9188U	HFHL9188U	B963448AU
HFH9189U		HFH9189U	HFHL9189U	B962766BU
HFH91810U		HFH91810U	HFHL91810U	B962626BU
HFH91812U		HFH91812U	HFHL91812U	B962735CU
HFH91814U		HFHD91814U	HFHL91814U	B962583DU
HFH91816U		HFH91816U	HFHL91816U	B963432AU
HFH91817U		HFH91817U	HFHL91817U	B963437AU
HFH91818U		HFH91818U	HFHL91818U	B963438AU
Price		<b>4,400JPY</b> /piece	<b>19,800JPY</b> /piece	<b>6,600JPY</b> /box
Number of panel per package		10 pieces/box (Ordering Unit 1piece)	1piece	1 set/box Inorganic ever-drying type Paint Base(10g)1piece, Hardener(7g)1piece, Primer(7.5g)1piece,brush2pieces

# Strahl FT

Coating performance	Weather resistance	Installation
Photocatalytic Self-cleaning	Weather resistance grade ★★★	Installation Horizontal



FH7171K



FH7172K



FH7173K



FH7175K

## Specifications

Size	16×455(exposed width)×3030mm
Price	<b>10,000 JPY</b> /piece 7,250 JPY/m <sup>2</sup>
Number of panel per package	2pieces
Coverage	1.38m <sup>2</sup> /piece
Weight	Approx. 24kg/piece

## Outside corner

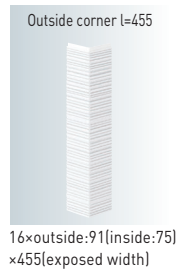

## Accessories list

Genuine accessories are required to install siding panels

Panel	Accessories	Outside corner l=455	Caulking (Holder set: B80E)	Repair Paint
FH7171K		FHD7171K	B84303051	B96L3167AK
FH7172K		FHD7172K	B84302491C	B96L3160AK
FH7173K		FHD7173K	B8430746	B96L1439BU
FH7175K		FHD7175K	B84303045	B96L3224BK
Price		<b>4,400 JPY</b> /piece	<b>6,600 JPY</b> /piece	<b>6,600 JPY</b> /box
Number of panel per package		10 pieces/box (Ordering Unit 1piece)	10 pieces/box <sup>*1</sup> (Ordering Unit 1piece) Caulking(600ml)10pieces, Primer,brush, nozzle2pieces <small>*Holder set are sold separately</small>	1 set/box Inorganic ever-drying type Paint Base(10g)1piece, Hardener(7g)1piece, Primer(7.5g)1piece,brush2pieces

<sup>\*1</sup> The dedicated primer (part number B85AA or B85BB) will be shipped at the same time.

# Fiotto FT

<b>Coating performance</b>	<b>Weather resistance</b>	<b>Installation</b>
Photocatalytic Self-cleaning	Weather resistance grade ★★★	Installation Horizontal and Vertical



FH4895U



FH4896U



FH4898U



FH4899U

## Specifications

Size	16×455(exposed width)×3030mm
Price	<b>10,000 JPY/piece</b> 7,250 JPY/m <sup>2</sup>
Number of panel per package	2pieces
Coverage	1.38m <sup>2</sup> /piece
Weight	Approx. 24kg/piece

## Outside corner

Outside corner l=455    Outside corner l=3030    Shiplap corner

Vertical installation with clips

16×outside:91(inside:75) ×455(exposed width)    16×outside:91(inside:75) ×3030

## Accessories list

Genuine accessories are required to install siding panels

Accessories	Outside corner l=455	Outside corner l=3030	Through Wall Flashing l=3030	Caulking (Holder set: B80E)	Repair Paint
Panel					
FH4895U	FHD4895U	FHP4895U	B2241W2	B8430577	B96L2540CU
FH4896U	FHD4896U	FHP4896U	B2241W2	B8430495	B96L1438HU
FH4898U	FHD4898U	FHP4898U	B2241W3	B8430713	B96L2416BU
FH4899U	FHD4899U	FHP4899U	B2241557	B84302546	B96L2546BU
Price	<b>4,400 JPY/piece</b>	<b>19,800 JPY/piece</b>	<b>3,200 JPY/piece</b>	<b>6,600 JPY/piece</b>	<b>6,600 JPY/box</b>
Number of panel per package	10 pieces/box (Ordering Unit 1piece)	1piece	5 pieces/box	10 pieces/box* <sup>1</sup> (Ordering Unit 1piece) Caulking(600ml)10pieces, Primer,brush,nozzle2pieces *Holder set are sold separately	1 set/box Inorganic ever-drying type Paint Base(10g)1piece, Hardener(7g)1piece, Primer(7.5g)1piece,brush2pieces

\*1 The dedicated primer (part number B85AA or B85BB) will be shipped at the same time.

# Scre Flat FT

<b>Coating performance</b>	<b>Weather resistance</b>	<b>Installation</b>
Photocatalytic Self-cleaning	Weather resistance grade ★★★	Installation Horizontal and Vertical

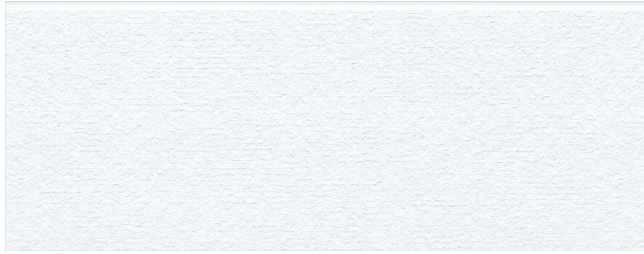

FH7281A



FH7282A



FH7283A

## Specifications

Size	16×455(exposed width)×3030mm
Price	<b>10,000JPY</b> /piece 7,250JPY/m <sup>2</sup>
Number of panel per package	2pieces
Coverage	1.38m <sup>2</sup> /piece
Weight	Approx. 25kg/piece

## Outside corner

Outside corner l=455    Outside corner l=3030    Shiplap corner  
Vertical installation with clips

16×outside:91(inside:75)×455(exposed width)    16×outside:91(inside:75)×3030

## Accessories list

Genuine accessories are required to install siding panels

Panel	Outside corner l=455	Outside corner l=3030	Through Wall Flashing l=3030	Caulking (Holder set: B80E)	Repair Paint
FH7281A	FHD7281A	FHP7281A	B22413058	B84303051	B96L3051CA
FH7282A	FHD7282A	FHP7282A	B2241W2	B84302491C	B96L2531EA
FH7283A	FHD7283A	FHP7283A	B2241W1	B84303045	B96L3222AA
Price	<b>4,400JPY</b> /piece	<b>19,800JPY</b> /piece	<b>3,200JPY</b> /piece	<b>6,600JPY</b> /piece	<b>6,600JPY</b> /box
Number of panel per package	10 pieces/box (Ordering Unit 1piece)	1piece	5 pieces/box	10 pieces/box*1 (Ordering Unit 1piece) Caulking(600ml)10pieces, Primer,brush,nozzle2pieces *Holder set are sold separately	1 set/box Inorganic ever-drying type Paint Base(10g)1piece, Hardener(7g)1piece, Primer(7.5g)1piece,brush2pieces

\*1 The dedicated primer (part number B85AA or B85BB) will be shipped at the same time.

# Cast Stripe FT

<b>Coating performance</b> Photocatalytic Self-cleaning	<b>Weather resistance</b> Weather resistance grade ★★ ★	<b>Installation</b> Installation Horizontal and Vertical
--	--	---



HFH7461U



HFH7462U



HFH7463U





HFH7464U

## Specifications

Size	16×455(exposed width)×3030mm
Price	<b>10,000JPY</b> /piece 7,250JPY/m <sup>2</sup>
Number of panel per package	2pieces
Coverage	1.38m <sup>2</sup> /piece
Weight	Approx. 25kg/piece

## Outside corner

<p>Outside corner l=455</p>  <p>16×outside:91(inside:75) ×455(exposed width)</p>	<p>Outside corner l=3030</p>  <p>16×outside:91(inside:75) ×3030</p>
---	---

## Accessories list

Genuine accessories are required to install siding panels

Panel	Accessories	Outside corner l=455	Outside corner l=3030	Repair Paint
HFH7461U		HFHD7461U	HFHL7461U	B962540BU
HFH7462U		HFHD7462U	HFHL7462U	B962628BU
HFH7463U		HFHD7463U	HFHL7463U	B963448AU
HFH7464U		HFHD7464U	HFHL7464U	B963445AU
Price		<b>4,400JPY</b> /piece	<b>19,800JPY</b> /piece	<b>6,600JPY</b> /box
Number of panel per package		10 pieces/box (Ordering Unit 1piece)	1piece	1 set/box Inorganic ever-drying type Paint Base(10g)1piece, Hardener(7g)1piece, Primer(7.5g)1piece,brush2pieces

# Cashmere Smooth FT

Coating performance	Weather resistance	Installation
Photocatalytic Self-cleaning	Weather resistance grade ★★★	Installation Horizontal and Vertical



## Specifications

Size	16×455(exposed width)×3030mm
Price	<b>10,000JPY</b> /piece 7,250JPY/m <sup>2</sup>
Number of panel per package	2pieces
Coverage	1.38m <sup>2</sup> /piece
Weight	Approx. 26kg/piece

## Outside corner

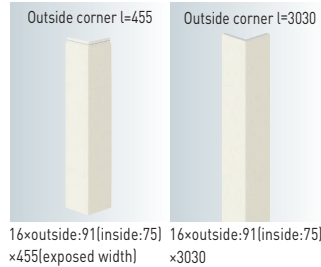

## Accessories list

Genuine accessories are required to install siding panels

Panel	Accessories	Outside corner l=455	Outside corner l=3030	Repair Paint
HFH9161A		HFHD9161A	HFHL9161A	B963051AU
HFH9162A		HFHD9162A	HFHL9162A	B962540BU
HFH9163A		HFHD9163A	HFHL9163A	B962531BU
HFH9164A		HFHD9164A	HFHL9164A	B963444AU
HFH9165A		HFHD9165A	HFHL9165A	B963445AU
HFH9166A		HFHD9166A	HFHL9166A	B963446AU
HFH9167A		HFHD9167A	HFHL9167A	B963447AU
HFH9168A		HFHD9168A	HFHL9168A	B963448AU
HFH9169A		HFHD9169A	HFHL9169A	B962766BU
HFH91610A		HFHD91610A	HFHL91610A	B962626BU
HFH91612A		HFHD91612A	HFHL91612A	B962735CU
HFH91614A		HFHD91614A	HFHL91614A	B962583DU
HFH91616A		HFHD91616A	HFHL91616A	B963432AU
HFH91617A		HFHD91617A	HFHL91617A	B963437AU
HFH91618A		HFHD91618A	HFHL91618A	B963438AU
Price		<b>4,400JPY</b> /piece	<b>19,800JPY</b> /piece	<b>6,600JPY</b> /box
Number of panel per package		10 pieces/box (Ordering Unit 1piece)	1piece	1 set/box Inorganic ever-drying type Paint Base(9g)1piece, Hardener(7g)1piece, Primer(7.5g)1piece,brush2pieces

# Zen Garden FT

<b>Coating performance</b>	<b>Weather resistance</b>	<b>Installation</b>
Photocatalytic Self-cleaning	Weather resistance grade ★★★	Installation Horizontal and Vertical



## Specifications

Size	16×455(exposed width)×3030mm
Price	<b>10,000JPY</b> /piece 7,250JPY/m <sup>2</sup>
Number of panel per package	2pieces
Coverage	1.38m <sup>2</sup> /piece
Weight	Approx. 22kg/piece

## Outside corner

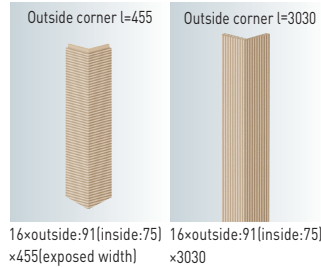

## Accessories list

Genuine accessories are required to install siding panels

Panel	Accessories	Outside corner l=455	Outside corner l=3030	Repair Paint
HFH9121U		HFHD9121U	HFHL9121U	B963051AU
HFH9122U		HFHD9122U	HFHL9122U	B962540BU
HFH9123U		HFHD9123U	HFHL9123U	B962531BU
HFH9124U		HFHD9124U	HFHL9124U	B963444AU
HFH9125U		HFHD9125U	HFHL9125U	B963445AU
HFH9126U		HFHD9126U	HFHL9126U	B963446AU
HFH9127U		HFHD9127U	HFHL9127U	B963447AU
HFH9128U		HFHD9128U	HFHL9128U	B963448AU
HFH9129U		HFHD9129U	HFHL9129U	B962766BU
HFH91210U		HFHD91210U	HFHL91210U	B962626BU
HFH91212U		HFHD91212U	HFHL91212U	B962735CU
HFH91214U		HFHD91214U	HFHL91214U	B962583DU
HFH91216U		HFHD91216U	HFHL91216U	B963432AU
HFH91217U		HFHD91217U	HFHL91217U	B963437AU
HFH91218U		HFHD91218U	HFHL91218U	B963438AU
Price		<b>4,400JPY</b> /piece	<b>19,800JPY</b> /piece	<b>6,600JPY</b> /box
Number of panel per package		10 pieces/box (Ordering Unit 1piece)	1piece	1 set/box Inorganic ever-drying type Paint Base(9g)1piece, Hardener(7g)1piece, Primer(7.5g)1piece,brush2pieces

# 3 Reveal FT

<b>Coating performance</b> Photocatalytic Self-cleaning	<b>Weather resistance</b> Weather resistance grade ★★★	<b>Installation</b> Installation Horizontal and Vertical
--	---	---



## Specifications

Size	16×455(exposed width)×3030mm
Price	<b>10,000JPY</b> /piece 7,250JPY/m <sup>2</sup>
Number of panel per package	2pieces
Coverage	1.38m <sup>2</sup> /piece
Weight	Approx. 25kg/piece

## Outside corner



## Accessories list

Genuine accessories are required to install siding panels

Panel	Accessories	Outside corner l=455	Outside corner l=3030	Repair Paint
HFH9191A		HFHD9191A	HFHL9191A	B963051AU
HFH9192A		HFHD9192A	HFHL9192A	B962540BU
HFH9193A		HFHD9193A	HFHL9193A	B962531BU
HFH9194A		HFHD9194A	HFHL9194A	B963444AU
HFH9195A		HFHD9195A	HFHL9195A	B963445AU
HFH9196A		HFHD9196A	HFHL9196A	B963446AU
HFH9197A		HFHD9197A	HFHL9197A	B963447AU
HFH9198A		HFHD9198A	HFHL9198A	B963448AU
HFH9199A		HFHD9199A	HFHL9199A	B962766BU
HFH91910A		HFHD91910A	HFHL91910A	B962626BU
HFH91912A		HFHD91912A	HFHL91912A	B962735CU
HFH91914A		HFHD91914A	HFHL91914A	B962583DU
HFH91916A		HFHD91916A	HFHL91916A	B963432AU
HFH91917A		HFHD91917A	HFHL91917A	B963437AU
HFH91918A		HFHD91918A	HFHL91918A	B963438AU
Price		<b>4,400JPY</b> /piece	<b>19,800JPY</b> /piece	<b>6,600JPY</b> /box
Number of panel per package		10 pieces/box (Ordering Unit 1piece)	1piece	1 set/box <small>Inorganic ever-drying type Paint Base(9g)1piece, Hardener(7g)1piece, Primer(7.5g)1piece,brush2pieces</small>

# 8 Reveal FT

Coating performance Photocatalytic Self-cleaning	Weather resistance Weather resistance grade ★★★	Installation Installation Horizontal and Vertical
---	--	--



## Specifications

Size	16×455(exposed width)×3030mm
Price	<b>10,000 JPY</b> /piece 7,250JPY/m <sup>2</sup>
Number of panel per package	2pieces
Coverage	1.38m <sup>2</sup> /piece
Weight	Approx. 25kg/piece

## Outside corner

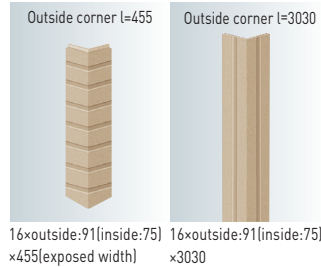

## Accessories list

Genuine accessories are required to install siding panels

Panel	Accessories	Outside corner l=455	Outside corner l=3030	Repair Paint
HFH9131U		HFHD9131U	HFHL9131U	B963051AU
HFH9132U		HFHD9132U	HFHL9132U	B962540BU
HFH9133U		HFHD9133U	HFHL9133U	B962531BU
HFH9134U		HFHD9134U	HFHL9134U	B963444AU
HFH9135U		HFHD9135U	HFHL9135U	B963445AU
HFH9136U		HFHD9136U	HFHL9136U	B963446AU
HFH9137U		HFHD9137U	HFHL9137U	B963447AU
HFH9138U		HFHD9138U	HFHL9138U	B963448AU
HFH9139U		HFHD9139U	HFHL9139U	B962766BU
HFH91310U		HFHD91310U	HFHL91310U	B962626BU
HFH91312U		HFHD91312U	HFHL91312U	B962735CU
HFH91314U		HFHD91314U	HFHL91314U	B962583DU
HFH91316U		HFHD91316U	HFHL91316U	B963432AU
HFH91317U		HFHD91317U	HFHL91317U	B963437AU
HFH91318U		HFHD91318U	HFHL91318U	B963438AU
Price		<b>4,400 JPY</b> /piece	<b>19,800 JPY</b> /piece	<b>6,600 JPY</b> /box
Number of panel per package		10 pieces/box (Ordering Unit 1piece)	1piece	1 set/box <small>Inorganic ever-drying type Paint Base(9g)1piece, Hardener(7g)1piece, Primer(7.5g)1piece,brush2pieces</small>



# Stripe 8 FT

<b>Coating performance</b> Photocatalytic Self-cleaning	<b>Weather resistance</b> Weather resistance grade ★★★	<b>Installation</b> Installation Horizontal and Vertical
--	---	---



FH7501EK



FH7502EK



FH7503EK



FH7504EK



FH7505EK



FH7506EK

## Specifications

Size	16×455(exposed width)×3030mm	
Price	Optional Color	10,600JPY/piece 7,690JPY/m <sup>2</sup>
	FH7501EK/ FH7502EK/ FH7503EK	10,000JPY/piece 7,250JPY/m <sup>2</sup>
	Number of panel per package	2pieces
Coverage	1.38m <sup>2</sup> /piece	
Weight	Approx. 28kg/piece	

## Outside corner

Outside corner l=455      Outside corner l=3030      Shiplap corner

Vertical installation with clips

16×outside:91(inside:75)×455(exposed width)      16×outside:91(inside:75)×3030

## Accessories list

Genuine accessories are required to install siding panels

Accessories		Outside corner l=455	Outside corner l=3030	Through Wall Flashing l=3030	Caulking (Holder set: B80E)	Repair Paint
Panel	FH7501EK	FHD7501EK	FHP7501EK	B22413058	B84303044	B963064AK
	FH7502EK	FHD7502EK	FHP7502EK	B2241W2	B84302491C	B962551BK
	FH7503EK	FHD7503EK	FHP7503EK	B2241W1	B84303045	B963091CK
Optional Color	FH7504EK	FHD7504EK	FHP7504EK	B2241557	B8430580	B961772BK
	FH7505EK	FHD7505EK	FHP7505EK	B2241W4	B84302503	B962720BK
	FH7506EK	FHD7506EK	FHP7506EK	B2241549	B84303212	B963316AK
Price	4,400JPY/piece	19,800JPY/piece	3,200JPY/piece	6,600JPY/piece	6,600JPY/box	
Number of panel per package	10 pieces/box (Ordering Unit 1piece)	1piece	5 pieces/box	10 pieces/box <sup>1)</sup> (Ordering Unit 1piece)	1 set/box	
				Caulking(600ml)10pieces, Primer,brush,nozzle2pieces *Holder set are sold separately	Inorganic ever-drying type Paint Base(10g)1piece, Hardener(7g)1piece, Primer(7.5g)1piece,brush2pieces	

<sup>1)</sup> The dedicated primer (part number B85AA or B85BB) will be shipped at the same time.



# Flat FT

Coating performance	Weather resistance	Installation
Photocatalytic Self-cleaning	Weather resistance grade ★★★	Installation Horizontal and Vertical

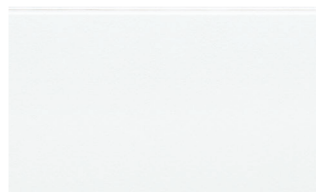

FH7493EK

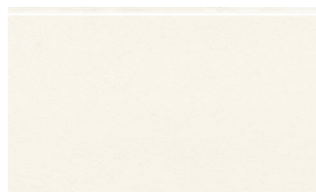

FH7494EK



FH74920EK

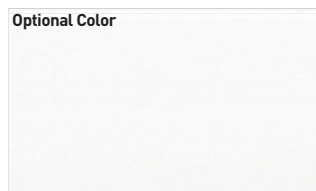

FH7491EK

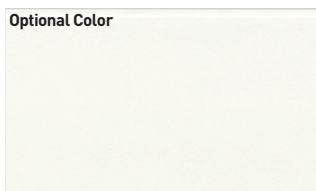

FH7492EK

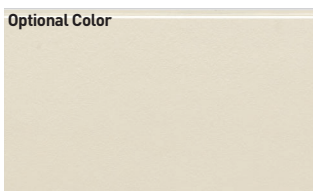

FH7495EK

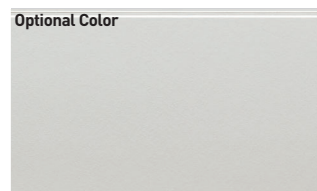

FH7497EK

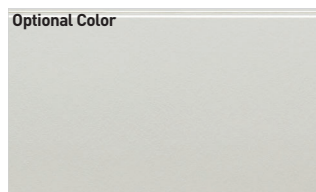

FH7496EK

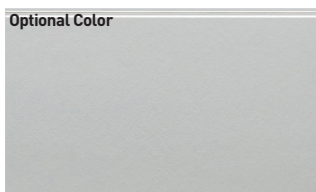

FH7498EK

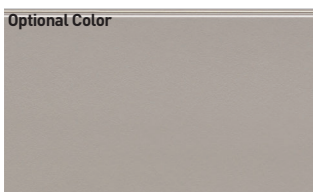

FH7499EK

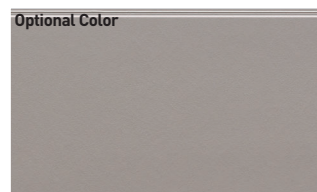

FH74910EK



FH74913EK



FH74918EK



FH74919EK



FH74916EK



FH74912EK



FH74915EK



FH74917EK

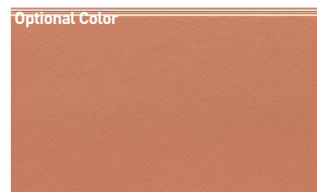

FH74911EK

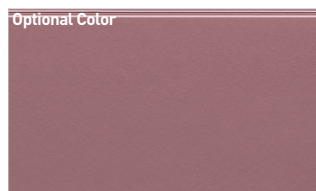

FH74914EK

## Specifications

Size	16×455(exposed width)×3030mm
Price	Optional Color 10,600JPY/piece 7,690JPY/m <sup>2</sup>
	FH7493EK/ FH7494EK/ FH74920EK 10,000JPY/piece 7,250JPY/m <sup>2</sup>
Number of panel per package	2pieces
Coverage	1.38m <sup>2</sup> /piece
Weight	Approx. 29kg/piece

## Outside corner

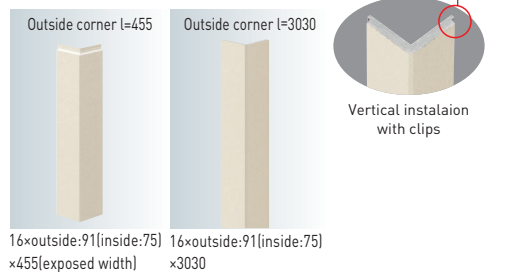

## Accessories list

Genuine accessories are required to install siding panels

Panel	Accessories	Outside corner l=455	Outside corner l=3030	Through Wall Flashing l=3030	Caulking (Holder set: B80E)	Repair Paint
FH7493EK		FHD7493EK	FHP7493EK	B22413058	B84303044	B963064AK
FH7494EK		FHD7494EK	FHP7494EK	B2241W2	B84302491C	B962551BK
FH74920EK		FHD74920EK	FHP74920EK	B2241W1	B84303045	B963091CK
Optional Color	FH7491EK	FHD7491EK	FHP7491EK	B22413058	B8430577	B962669DK
	FH7492EK	FHD7492EK	FHP7492EK	B2241W2	B8430577	B962592BK
	FH7495EK	FHD7495EK	FHP7495EK	B2241578	B8430976	B96746DK
	FH7496EK	FHD7496EK	FHP7496EK	B2241557	B84302546	B961765CK
	FH7497EK	FHD7497EK	FHP7497EK	B2241557	B8430557	B96788BK
	FH7498EK	FHD7498EK	FHP7498EK	B2241557	B8430580	B961772CK
	FH7499EK	FHD7499EK	FHP7499EK	B2241W4	B84301453	B961453CK
	FH74910EK	FHD74910EK	FHP74910EK	B2241W4	B84302503	B962720DK
	FH74911EK	FHD74911EK	FHP74911EK	B2241W1(Black)/ B2241W2(White)/ B2241W3(Brown)/ B2241W4(Gray)	B84303218	B963329AK
	FH74912EK	FHD74912EK	FHP74912EK		B84301781	B961781BK
	FH74913EK	FHD74913EK	FHP74913EK	B2241549	B84303212	B963316BK
	FH74914EK	FHD74914EK	FHP74914EK	B2241461	B84303005A	B963015BK
	FH74915EK	FHD74915EK	FHP74915EK	B2241549	B8430749B	B96749DK
	FH74916EK	FHD74916EK	FHP74916EK	B2241462	B84301758A	B96747DK
	FH74917EK	FHD74917EK	FHP74917EK	B22413114	B8430707C	B96707DK
FH74918EK	FHD74918EK	FHP74918EK	B2241549	B8430743	B96743FK	
FH74919EK	FHD74919EK	FHP74919EK	B2241W1	B8430719A	B96719CK	
Price		4,400JPY/piece	19,800JPY/piece	3,200JPY/piece	6,600JPY/piece	6,600JPY/box
Number of panel per package		10 pieces/box (Ordering Unit 1piece)	1piece	5 pieces/box	10 pieces/box <sup>1</sup> (Ordering Unit 1piece)	1 set/box
					Caulking(600ml)10pieces, Primer,brush,nozzle2pieces *Holder set are sold separately	Inorganic ever-drying type Paint Base(10g)1piece, Hardener(7g)1piece, Primer(7.5g)1piece,brush2pieces

<sup>1</sup>The dedicated primer (part number B85AA or B85BB) will be shipped at the same time.



Filltect E Hydrophilic 16  
Asis Flat FT  
FW7552EK

## Filltect N Hydrophilic 16

## Filltect E Hydrophilic 16

### Filltect N Hydrophilic 16

Ridge Wave FT  
 Accurate FT  
 New Slim Stone FT  
 Natural Brick FT  
 Ofen Brick FT  
 Tiers Tile FT  
 Drawer Tile FT  
 Sephiro Wood FT  
 Smash Line FT  
 Stripe 10 FT  
 Strahl FT  
 Fiotto FT  
 Scre Flat FT

### Filltect E Hydrophilic 16

Asis Flat FT  
 Stripe 8 FT  
 Flat FT

### Joint Alignment & Connection Sections

#### Joint Alignment with Caulking

- To enhance the natural appearance of the design, the joint width intentionally varies.  
 In addition, the joints on both sides of the caulking may be misaligned by approximately 3mm.
- The joint width varies to create a natural design expression.
- The joints on either side of the caulking may be offset by around 3mm.

#### Connection Sections

A joint is placed every approx. 455mm in the vertical direction.  
 Depending on lighting conditions, sunlight, or viewing angle, subtle shadows or slight gaps may appear along the joint lines.

### Performance List

item	unit	Filltect N Hydrophilic 16	Filltect E Hydrophilic 16	note
		16mm thickness		
specific gravity	—	1.0*	1.2*	Drying at 105°C for 24 hours
Water content	%	20 or under	20 or under	JISA5422
Water absorption rate	%	50 or under	50 or under	Water absorption 24h→105°C 24h
Bending Failure Load	N	785 or over	785 or over	JISA5422
Impact resistance	—	Passed	Passed	JISA5422

\*These are our measured values.

# Filltect N Hydrophilic 16

16 mm thickness | Filltect N Hydrophilic 16

16x455x3030(mm) | 8,300JPY/piece 6,020JPY/m<sup>2</sup>

Hydrophilic Self-cleaning  
Weather resistance grade ★

## Ridge Wave FT

Installation  
Horizontal



FW4911U



FW4913U



FW4914U

## Accurate FT

Installation  
Horizontal



FW7131U



FW7132U



FW7133U



FW7134U

## New Slim Stone FT

Installation  
Horizontal and Vertical



FW4861K



FW4863K



FW4864K



FW4865K

## Natural Brick FT

Installation  
Horizontal



FW4921U



FW4922U



FW4924U

## Ofen Brick FT

Installation  
Horizontal



FW7155A



FW7156A



FW7157A



FW7158A

## Tiers Tile FT

Installation  
Horizontal



FW7141A



FW7142A



FW7143A



FW7144A



FW7145A



FW7146A

## Drawer Tile FT

Installation  
Horizontal



FW4931U



FW4932U



FW4933U



FW4934U

## Sephiro wood FT

Installation  
Horizontal and Vertical



FW4871U



FW4872U



FW4873U



FW4874U

# Filltect N Hydrophilic 16

16 mm thickness | Filltect N Hydrophilic 16

16×455×3030(mm) | 8,300JPY/piece 6,020JPY/m<sup>2</sup>

Hydrophilic Self-cleaning  
Weather resistance grade ★

## Smash Line FT

Installation  
Horizontal



FW4881K



FW4882K



FW4883K



FW4884K

## Stripe 10 FT

Installation  
Horizontal  
and  
Vertical



FW7161K



FW7162K



FW7163K



FW7164K



FW7165K



FW7167K

## Strahl FT

Installation  
Horizontal

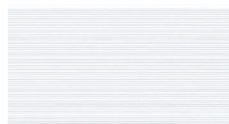

FW7171K

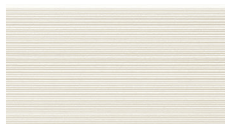

FW7172K



FW7173K



FW7175K

## Fiotto FT

Installation  
Horizontal  
and  
Vertical



FW4891U



FW4892U



FW4894U



FW4895U

## Scree Flat FT

Installation  
Horizontal  
and  
Vertical



FW7281A

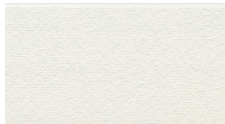

FW7282A



FW7283A

# Filltect E Hydrophilic 16

16 mm thickness | Filltect E Hydrophilic 16

16×455×3030(mm)

Optional Color : **8,900JPY**/piece 6,460JPY/m<sup>2</sup>  
 FW7501EK, FW7502EK, FW7503EK, FW7493EK, FW7494EK, FW74920EK : **8,300JPY**/piece 6,020JPY/m<sup>2</sup>

Hydrophilic Self-cleaning  
 Weather resistance grade ★

## Asis Flat FT

Installation Horizontal and Vertical



## Stripe 8 FT

Installation Horizontal and Vertical

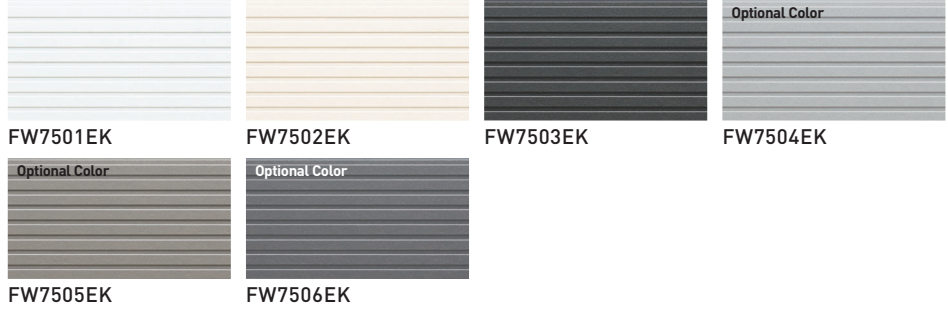

## Flat FT

Installation Horizontal and Vertical





# Ridge Wave FT

Coating performance	Weather resistance	Installation
Hydrophilic Self-cleaning	Weather resistance grade ★	Installation Horizontal



FW4911U



FW4913U



FW4914U

## Specifications

Size	16×455(exposed width)×3030mm
Price	<b>8,300JPY</b> /piece 6,020JPY/m <sup>2</sup>
Number of panel per package	2pieces
Coverage	1.38m <sup>2</sup> /piece
Weight	Approx. 24kg/piece

## Outside corner

Outside corner l=455

16×outside:91(inside:75)  
×455(exposed width)

## Accessories list

Genuine accessories are required to install siding panels

Panel	Accessories	Outside corner l=455	Caulking (Holder set: B80E)	Repair Paint	
FW4911U		FWD4911U	B84303859	B93HB3003BU	B93HB3080AU
FW4913U		FWD4913U	B8430409	B93HB2413BU	B93HB3098BU
FW4914U		FWD4914U	B84303878	B93HB2417AU	B93HB3220BU
Price		<b>4,200JPY</b> /piece	<b>6,600JPY</b> /piece	<b>2,900JPY</b> /bottle	
Number of panel per package	10 pieces/box (Ordering Unit 1piece)	10 pieces/box <sup>*1</sup> (Ordering Unit 1piece)		60g/bottle	
		Caulking(600ml)10pieces, Primer,brush,nozzle2pieces			
		*Holder set are sold separately			

\*1 The dedicated primer (part number B85AA or B85BB) will be shipped at the same time.

# Accurate FT

Coating performance	Weather resistance	Installation
Hydrophilic Self-cleaning	Weather resistance grade ★	Installation Horizontal



FW7131U



FW7132U



FW7133U



FW7134U

## Specifications

Size	16×455(exposed width)×3030mm
Price	<b>8,300JPY/piece</b> 6,020JPY/m <sup>2</sup>
Number of panel per package	2pieces
Coverage	1.38m <sup>2</sup> /piece
Weight	Approx. 25kg/piece

## Outside corner

Outside corner l=455

16×outside:91(inside:75)  
×455(exposed width)

## Accessories list

Genuine accessories are required to install siding panels

Panel	Accessories			
	Outside corner l=455	Caulking (Holder set: B80E)	Repair Paint	
FW7131U	FWD7131U	B84302491C	B93HB2670AU	—
FW7132U	FWD7132U	B84303211	B93HB1436AU (Light color)	B93HB3213AU (Dark color)
FW7133U	FWD7133U	B84303045	B93HB2583AU (Light color)	B93HB3210AU (Dark color)
FW7134U	FWD7134U	B84303045	B93HB2416BU	—
Price	4,200JPY/piece	6,600JPY/piece	2,900JPY/bottle	
Number of panel per package	10 pieces/box (Ordering Unit 1piece)	10 pieces/box <sup>*1</sup> (Ordering Unit 1piece)	60g/bottle	
		Caulking(600ml)10pieces, Primer,brush,nozzle2pieces		
*Holder set are sold separately				

\*1 The dedicated primer (part number B85AA or B85BB) will be shipped at the same time.

# New Slim Stone FT

Coating performance	Weather resistance	Installation
Hydrophilic Self-cleaning	Weather resistance grade ★	Installation Horizontal and Vertical



FW4861K



FW4863K



FW4864K



FW4865K

## Specifications

Size	16×455(exposed width)×3030mm
Price	<b>8,300JPY</b> /piece 6,020JPY/m <sup>2</sup>
Number of panel per package	2pieces
Coverage	1.38m <sup>2</sup> /piece
Weight	Approx. 24kg/piece

## Outside corner

Outside corner l=455



16×outside:91(inside:75) ×455(exposed width)

Outside corner l=3030



16×outside:91(inside:75) ×3030

Shiplap corner



Vertical installation with clips

## Accessories list

Genuine accessories are required to install siding panels

Panel	Accessories		Through Wall Flashing l=3030	Caulking (Holder set: B80E)	Repair Paint	
	Outside corner l=455	Outside corner l=3030				
FW4861K	FWD4861K	FWP4861K	B2241W2	B84301944	B93HB3160BNK	—
FW4863K	FWD4863K	FWP4863K	B2241W4	B84301937	B93HB3185ANK (Dark color)	B93HB3189ANK (Light color)
FW4864K	FWD4864K	FWP4864K	B2241550	B84301935A	B93HB3183ANK (Light color)	B93HB3187ANK (Dark color)
FW4865K	FWD4865K	FWP4865K	B22413114	B84303869	B93HB3235ANK (Dark color)	B93HB3238ANK (Light color)
Price	<b>4,200JPY</b> /piece	<b>19,300JPY</b> /piece	<b>3,200JPY</b> /piece	<b>6,600JPY</b> /piece	<b>2,900JPY</b> /bottle	
Number of panel per package	10 pieces/box (Ordering Unit 1piece)	1piece	5 pieces/box	10 pieces/box*1 (Ordering Unit 1piece) Caulking(600ml)10pieces, Primer,brush,nozzle2pieces *Holder set are sold separately	60g/bottle	

\*1 The dedicated primer (part number B85AA or B85BB) will be shipped at the same time.

# Natural Brick FT

Coating performance	Weather resistance	Installation
Hydrophilic Self-cleaning	Weather resistance grade ★	Installation Horizontal



FW4921U



FW4922U



FW4924U

## Specifications

Size	16×455(exposed width)×3030mm
Price	<b>8,300JPY</b> /piece 6,020JPY/m <sup>2</sup>
Number of panel per package	2pieces
Coverage	1.38m <sup>2</sup> /piece
Weight	Approx. 25kg/piece

## Outside corner

Outside corner l=455

16×outside:91(inside:75)  
×455(exposed width)

## Accessories list

Genuine accessories are required to install siding panels

Panel	Accessories		Repair Paint	
	Outside corner l=455	Caulking (Holder set: B80E)		
FW4921U	FWD4921U	B8430746	B93HB1438CU	—
FW4922U	FWD4922U	B8430427	B93HB2413CU	B93HB3098CU
FW4924U	FWD4924U	B84302636	—	B93HB3098DU
Price	<b>4,200JPY</b> /piece	<b>6,600JPY</b> /piece	<b>2,900JPY</b> /bottle	
Number of panel per package	10 pieces/box (Ordering Unit 1piece)	10 pieces/box <sup>*1</sup> (Ordering Unit 1piece)	60g/bottle	
		Caulking(600ml)10pieces, Primer,brush,nozzle2pieces <small>*Holder set are sold separately</small>		

\*1 The dedicated primer (part number B85AA or B85BB) will be shipped at the same time.

# Ofen Brick FT

Coating performance	Weather resistance	Installation
Hydrophilic Self-cleaning	Weather resistance grade ★	Installation Horizontal



FW7155A



FW7156A



FW7157A



FW7158A

## Specifications

Size	16×455(exposed width)×3030mm
Price	<b>8,300JPY/piece</b> 6,020JPY/m <sup>2</sup>
Number of panel per package	2pieces
Coverage	1.38m <sup>2</sup> /piece
Weight	Approx. 25kg/piece

## Outside corner

Outside corner l=455

16×outside:91(inside:75)  
×455(exposed width)

## Accessories list

Genuine accessories are required to install siding panels

Panel	Accessories	Outside corner l=455	Caulking (Holder set: B80E)	Repair Paint	
FW7155A		FWD7155A	B84304053	B93HB3106AA (Light color)	B93HB3318AA (Dark color)
FW7156A		FWD7156A	B84301843	B93HB2627CA	—
FW7157A		FWD7157A	B8430409	B93HB3217BA	—
FW7158A		FWD7158A	B8430522B	B93HB3222CA	—
Price		4,200JPY/piece	6,600JPY/piece	2,900JPY/bottle	
Number of panel per package	10 pieces/box (Ordering Unit 1piece)	10 pieces/box <sup>*1</sup> (Ordering Unit 1piece)		60g/bottle	
		Caulking(600ml)10pieces, Primer,brush,nozzle2pieces			
		*Holder set are sold separately			

\*1 The dedicated primer (part number B85AA or B85BB) will be shipped at the same time.

# Tiers Tile FT

Coating performance	Weather resistance	Installation
Hydrophilic Self-cleaning	Weather resistance grade ★	Installation Horizontal



FW7141A



FW7142A



FW7143A



FW7144A



FW7145A



FW7146A

## Specifications

Size	16×455(exposed width)×3030mm
Price	<b>8,300JPY/piece</b> 6,020JPY/m <sup>2</sup>
Number of panel per package	2pieces
Coverage	1.38m <sup>2</sup> /piece
Weight	Approx. 24kg/piece

## Outside corner

Outside corner l=455

16×outside:91(inside:75)  
×455(exposed width)

## Accessories list

Genuine accessories are required to install siding panels

Panel	Accessories			
	Outside corner l=455	Caulking (Holder set: B80E)	Repair Paint	
FW7141A	FWD7141A	B84301843	B93HB2456AA	—
FW7142A	FWD7142A	B84301843	B93HB2634BA	—
FW7143A	FWD7143A	B84302417B	B93HB3246AA	—
FW7144A	FWD7144A	B84303045	B93HB2417DA	—
FW7145A	FWD7145A	B84304053	B93HB3106AA (Light color)	B93HB3318AA (Dark color)
FW7146A	FWD7146A	B8430522B	B93HB3222CA	—
Price	4,200JPY/piece	6,600JPY/piece	2,900JPY/bottle	
Number of panel per package	10 pieces/box (Ordering Unit 1piece)	10 pieces/box <sup>*1</sup> (Ordering Unit 1piece)	60g/bottle	
		Caulking(600ml)10pieces, Primer,brush,nozzle2pieces <small>*Holder set are sold separately</small>		

\*1 The dedicated primer (part number B85AA or B85BB) will be shipped at the same time.

# Drawer Tile FT

Coating performance	Weather resistance	Installation
Hydrophilic Self-cleaning	Weather resistance grade ★	Installation Horizontal



FW4931U



FW4932U



FW4933U



FW4934U

## Specifications

Size	16×455(exposed width)×3030mm
Price	<b>8,300JPY</b> /piece 6,020JPY/m <sup>2</sup>
Number of panel per package	2pieces
Coverage	1.38m <sup>2</sup> /piece
Weight	Approx. 25kg/piece

## Outside corner

Outside corner l=455

16×outside:91(inside:75)  
×455(exposed width)

## Accessories list

Genuine accessories are required to install siding panels

Panel	Accessories	Outside corner l=455	Caulking (Holder set: B80E)	Repair Paint	
FW4931U		FWD4931U	B84303883	B93HB2531BU	B93HB2613AU
FW4932U		FWD4932U	B8430708	B93HB3246AU	B93HB2619BU
FW4933U		FWD4933U	B84302415A	B93HB3247AU	B93HB2811AU
FW4934U		FWD4934U	B84303841	B93HB2632AU	B93HB2417AU
Price		<b>4,200JPY</b> /piece	<b>6,600JPY</b> /piece	<b>2,900JPY</b> /bottle	
Number of panel per package	10 pieces/box (Ordering Unit 1piece)	10 pieces/box <sup>*1</sup> (Ordering Unit 1piece)		60g/bottle	
		Caulking(600ml)10pieces, Primer,brush,nozzle2pieces			
		*Holder set are sold separately			

\*1 The dedicated primer (part number B85AA or B85BB) will be shipped at the same time.

# Sephiro Wood FT

Coating performance	Weather resistance	Installation
Hydrophilic Self-cleaning	Weather resistance grade ★	Installation Horizontal and Vertical



FW4871U



FW4872U



FW4873U



FW4874U

## Specifications

Size	16×455(exposed width)×3030mm
Price	<b>8,300JPY</b> /piece 6,020JPY/m <sup>2</sup>
Number of panel per package	2pieces
Coverage	1.38m <sup>2</sup> /piece
Weight	Approx. 24kg/piece

## Outside corner

Outside corner l=455      Outside corner l=3030      Shiplap corner

Vertical installation with clips

16×outside:91(inside:75) ×455(exposed width)      16×outside:91(inside:75) ×3030

## Accessories list

Genuine accessories are required to install siding panels

Panel	Outside corner l=455	Outside corner l=3030	Through Wall Flashing l=3030	Caulking (Holder set: B80E)	Repair Paint
FW4871U	FWD4871U	FWP4871U	B2241578	B84302715	B93HB1438BU
FW4872U	FWD4872U	FWP4872U	B2241423	B84303068	B93HB3072AU
FW4873U	FWD4873U	FWP4873U	B2241476	B8430708	B93HB2618AU
FW4874U	FWD4874U	FWP4874U	B2241W1	B8430713A	B93HB2632AU
Price	<b>4,200JPY</b> /piece	<b>19,300JPY</b> /piece	<b>3,200JPY</b> /piece	<b>6,600JPY</b> /piece	<b>2,900JPY</b> /bottle
Number of panel per package	10 pieces/box (Ordering Unit 1piece)	1piece	5 pieces/box	10 pieces/box <sup>*1</sup> (Ordering Unit 1piece) Caulking(600ml)10pieces, Primer,brush,nozzle2pieces	60g/bottle
				*Holder set are sold separately	

\*1 The dedicated primer (part number B85AA or B85BB) will be shipped at the same time.

# Smash Line FT

Coating performance	Weather resistance	Installation
Hydrophilic Self-cleaning	Weather resistance grade ★	Installation Horizontal



FW4881K



FW4882K



FW4883K



FW4884K

## Specifications

Size	16×455(exposed width)×3030mm
Price	<b>8,300JPY</b> /piece 6,020JPY/m <sup>2</sup>
Number of panel per package	2pieces
Coverage	1.38m <sup>2</sup> /piece
Weight	Approx. 25kg/piece

## Outside corner

Outside corner l=455

16×outside:91(inside:75)  
×455(exposed width)

## Accessories list

Genuine accessories are required to install siding panels

Panel	Accessories	Outside corner l=455	Caulking (Holder set: B80E)	Repair Paint
FW4881K		FWD4881K	B84303044	B93HB3167ANK
FW4882K		FWD4882K	B84302491	B93HB3160CNK
FW4883K		FWD4883K	B8430495	B93HB1438AU
FW4884K		FWD4884K	B84303045	B93HB3224ANK
Price		<b>4,200JPY</b> /piece	<b>6,600JPY</b> /piece	<b>2,900JPY</b> /bottle
Number of panel per package		10 pieces/box (Ordering Unit 1piece)	10 pieces/box <sup>*1</sup> (Ordering Unit 1piece) Caulking(600ml)10pieces, Primer,brush,nozzle2pieces <small>*Holder set are sold separately</small>	60g/bottle

\*1 The dedicated primer (part number B85AA or B85BB) will be shipped at the same time.

# Stripe 10 FT

Coating performance	Weather resistance	Installation
Hydrophilic Self-cleaning	Weather resistance grade ★	Installation Horizontal and Vertical



FW7161K



FW7162K



FW7163K



FW7164K



FW7165K



FW7167K

## Specifications

Size	16×455(exposed width)×3030mm
Price	<b>8,300JPY</b> /piece 6,020JPY/m <sup>2</sup>
Number of panel per package	2pieces
Coverage	1.38m <sup>2</sup> /piece
Weight	Approx. 24kg/piece

## Outside corner

Outside corner l=455      Outside corner l=3030

Shiplap corner

Vertical installation with clips

16×outside:91(inside:75) ×455(exposed width)      16×outside:91(inside:75) ×3030

## Accessories list

Genuine accessories are required to install siding panels

Panel	Outside corner l=455	Outside corner l=3030	Through Wall Flashing l=3030	Caulking (Holder set: B80E)	Repair Paint
FW7161K	FWD7161K	FWP7161K	B2241W2	B84302491C	B93HB3160ANK
FW7162K	FWD7162K	FWP7162K	B2241549	B84303212	B93HB3391ANK
FW7163K	FWD7163K	FWP7163K	B2241462	B84301758A	B93HB3166BNK
FW7164K	FWD7164K	FWP7164K	B2241W3	B8430713	B93HB3152ANK
FW7165K	FWD7165K	FWP7165K	B2241W1(Black)/B2241W2(White)/B2241W3(Brown)/B2241W4(Gray)	B84303218	B93HB3218AU
FW7167K	FWD7167K	FWP7167K	B2241549	B84303219	B93HB3394ANK
Price	4,200JPY/piece	19,300JPY/piece	3,200JPY/piece	6,600JPY/piece	2,900JPY/bottle
Number of panel per package	10 pieces/box (Ordering Unit 1piece)	1piece	5 pieces/box	10 pieces/box <sup>*1</sup> (Ordering Unit 1piece) Caulking(600ml)10pieces, Primer,brush, nozzle2pieces <small>*Holder set are sold separately</small>	60g/bottle

\*1 The dedicated primer (part number B85AA or B85BB) will be shipped at the same time.

# Strahl FT

Coating performance	Weather resistance	Installation
Hydrophilic Self-cleaning	Weather resistance grade ★	Installation Horizontal



FW7171K



FW7172K



FW7173K



FW7175K

## Specifications

Size	16×455(exposed width)×3030mm
Price	<b>8,300JPY</b> /piece 6,020JPY/m <sup>2</sup>
Number of panel per package	2pieces
Coverage	1.38m <sup>2</sup> /piece
Weight	Approx. 24kg/piece

## Outside corner

Outside corner l=455

16×outside:91(inside:75)  
×455(exposed width)

## Accessories list

Genuine accessories are required to install siding panels

Panel	Accessories	Outside corner l=455	Caulking (Holder set: B80E)	Repair Paint
FW7171K		FWD7171K	B84303051	B93HB3167ANK
FW7172K		FWD7172K	B84302491C	B93HB3160ANK
FW7173K		FWD7173K	B8430746	B93HB3148ANK
FW7175K		FWD7175K	B84303045	B93HB3224ANK
Price		<b>4,200JPY</b> /piece	<b>6,600JPY</b> /piece	<b>2,900JPY</b> /bottle
Number of panel per package		10 pieces/box (Ordering Unit 1piece)	10 pieces/box <sup>*1</sup> (Ordering Unit 1piece) Caulking(600ml)10pieces, Primer,brush,nozzle2pieces	60g/bottle
			*Holder set are sold separately	

\*1 The dedicated primer (part number B85AA or B85BB) will be shipped at the same time.

# Fiotto FT

Coating performance	Weather resistance	Installation
Hydrophilic Self-cleaning	Weather resistance grade ★	Installation Horizontal and Vertical



FW4891U



FW4892U



FW4894U



FW4895U

## Specifications

Size	16×455(exposed width)×3030mm
Price	<b>8,300JPY</b> /piece 6,020JPY/m <sup>2</sup>
Number of panel per package	2pieces
Coverage	1.38m <sup>2</sup> /piece
Weight	Approx. 24kg/piece

## Outside corner

Outside corner l=455    Outside corner l=3030    Shiplap corner

Vertical installation with clips

16×outside:91(inside:75) ×455(exposed width)    16×outside:91(inside:75) ×3030

## Accessories list

Genuine accessories are required to install siding panels

Panel	Outside corner l=455	Outside corner l=3030	Through Wall Flashing l=3030	Caulking (Holder set: B80E)	Repair Paint
FW4891U	FWD4891U	FWP4891U	B2241W2	B8430577	B93HB2540AU
FW4892U	FWD4892U	FWP4892U	B2241W2	B8430495	B93HB1438AU
FW4894U	FWD4894U	FWP4894U	B2241W3	B8430713A	B93HB2416AU
FW4895U	FWD4895U	FWP4895U	B2241557	B84302546	B93HB2546AU
Price	4,200JPY/piece	19,300JPY/piece	3,200JPY/piece	6,600JPY/piece	2,900JPY/bottle
Number of panel per package	10 pieces/box (Ordering Unit 1piece)	1piece	5 pieces/box	10 pieces/box <sup>*1</sup> (Ordering Unit 1piece) Caulking(600ml)10pieces, Primer,brush,nozzle2pieces	60g/bottle
				*Holder set are sold separately	

\*1 The dedicated primer (part number B85AA or B85BB) will be shipped at the same time.

# Scre Flat FT

Coating performance	Weather resistance	Installation
Hydrophilic Self-cleaning	Weather resistance grade ★	Installation Horizontal and Vertical

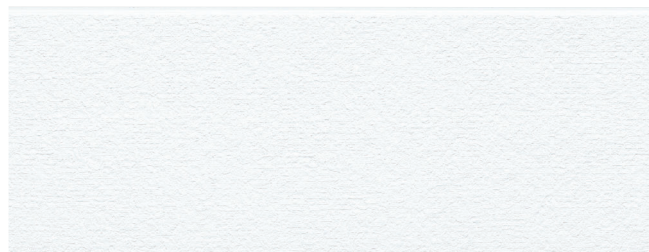

FW7281A

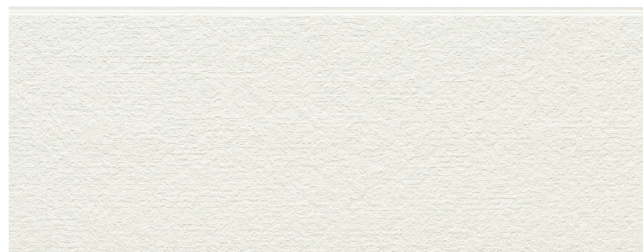

FW7282A



FW7283A

## Specifications

Size	16×455(exposed width)×3030mm
Price	<b>8,300JPY</b> /piece 6,020JPY/m <sup>2</sup>
Number of panel per package	2pieces
Coverage	1.38m <sup>2</sup> /piece
Weight	Approx. 25kg/piece

## Outside corner

Outside corner l=455    Outside corner l=3030

Shiplap corner  
Vertical installation with clips

16×outside:91(inside:75) ×455(exposed width)    16×outside:91(inside:75) ×3030

## Accessories list

Genuine accessories are required to install siding panels

Panel	Outside corner l=455	Outside corner l=3030	Through Wall Flashing l=3030	Caulking (Holder set: B80E)	Repair Paint
FW7281A	FWD7281A	FWP7281A	B22413058	B84303051	B93HB3051AA
FW7282A	FWD7282A	FWP7282A	B2241W2	B84302491	B93HB2531AA
FW7283A	FWD7283A	FWP7283A	B2241W1	B84303045	B93HB3222BA
Price	<b>4,200JPY</b> /piece	<b>19,300JPY</b> /piece	<b>3,200JPY</b> /piece	<b>6,600JPY</b> /piece	<b>2,900JPY</b> /bottle
Number of panel per package	10 pieces/box (Ordering Unit 1piece)	1piece	5 pieces/box	10 pieces/box <sup>*1</sup> (Ordering Unit 1piece) Caulking(600ml)10pieces, Primer,brush,nozzle2pieces	60g/bottle

\*Holder set are sold separately

\*1 The dedicated primer (part number B85AA or B85BB) will be shipped at the same time.



# Asis Flat FT

Coating performance	Weather resistance	Installation
Hydrophilic Self-cleaning	Weather resistance grade ★	Installation Horizontal and Vertical



FW7551EK



FW7552EK



FW7553EK



FW7554EK

## Specifications

Size	16×455(exposed width)×3030mm
Price	<b>8,300JPY</b> /piece 6,020JPY/m <sup>2</sup>
Number of panel per package	2pieces
Coverage	1.38m <sup>2</sup> /piece
Weight	Approx. 29kg/piece

## Outside corner

Outside corner l=455



16×outside:91(inside:75)  
×455(exposed width)

Outside corner l=3030



16×outside:91(inside:75)  
×3030



Shiplap corner  
Vertical installation with clips

## Accessories list

Genuine accessories are required to install siding panels

Accessories Panel	Outside corner l=455	Outside corner l=3030	Through Wall Flashing l=3030	Caulking (Holder set: B80E)	Repair Paint	
FW7551EK	FWD7551EK	FWP7551EK	B2241557	B8430557	B93HB3124ANK (Dark color)	B93HB3401ANK (Light color)
FW7552EK	FWD7552EK	FWP7552EK	B2241425	B84302969	B93HB3396CNK (Light color)	B93HB3066BNK (Dark color)
FW7553EK	FWD7553EK	FWP7553EK	B2241550	B84302503A	B93HB3396DNK (Light color)	B93HB3290BNK (Dark color)
FW7554EK	FWD7554EK	FWP7554EK	B2241W1	B84301713B	B93HB3054ANK (Light color)	B93HB3097BNK (Dark color)
Price	4,200JPY/piece	19,300JPY/piece	3,200JPY/piece	6,600JPY/piece	2,900JPY/bottle	
Number of panel per package	10 pieces/box (Ordering Unit 1piece)	1piece	5 pieces/box	10 pieces/box <sup>*1</sup> (Ordering Unit 1piece)	60g/bottle	
				Caulking(600ml)10pieces, Primer,brush,nozzle2pieces		
				*Holder set are sold separately		

\*1 The dedicated primer (part number B85AA or B85BB) will be shipped at the same time.

# Stripe 8 FT

Coating performance	Weather resistance	Installation
Hydrophilic Self-cleaning	Weather resistance grade ★	Installation Horizontal and Vertical



FW7501EK

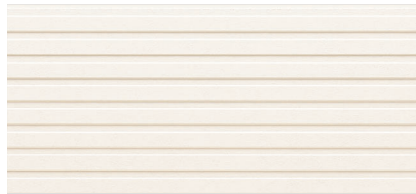

FW7502EK



FW7503EK



FW7504EK



FW7505EK



FW7506EK

## Specifications

Size	16×455(exposed width)×3030mm	
Price	Optional Color	<b>8,900JPY</b> /piece 6,460JPY/m <sup>2</sup>
	FW7501EK/ FW7502EK/ FW7503EK	<b>8,300JPY</b> /piece 6,020JPY/m <sup>2</sup>
	Number of panel per package	2pieces
Coverage	1.38m <sup>2</sup> /piece	
Weight	Approx. 28kg/piece	

## Outside corner

Outside corner l=455      Outside corner l=3030      Shiplap corner

Vertical installation with clips

16×outside:91(inside:75)×455(exposed width)      16×outside:91(inside:75)×3030

## Accessories list

Genuine accessories are required to install siding panels

Accessories		Outside corner l=455	Outside corner l=3030	Through Wall Flashing l=3030	Caulking (Holder set: B80E)	Repair Paint
Panel	FW7501EK	FWD7501EK	FWP7501EK	B22413058	B84303044	B93HB3064ANK
	FW7502EK	FWD7502EK	FWP7502EK	B2241W2	B84302491A	B93HB2551ANK
	FW7503EK	FWD7503EK	FWP7503EK	B2241W1	B84303045	B93HB3091ENK
Optional Color	FW7504EK	FWD7504EK	FWP7504EK	B2241557	B8430580	B93HB1772ANK
	FW7505EK	FWD7505EK	FWP7505EK	B2241W4	B84302503	B93HB2720BNK
	FW7506EK	FWD7506EK	FWP7506EK	B2241549	B84303212	B93HB3316ANK
Price	<b>4,200JPY</b> /piece	<b>19,300JPY</b> /piece	<b>3,200JPY</b> /piece	<b>6,600JPY</b> /piece	<b>2,900JPY</b> /bottle	
Number of panel per package	10 pieces/box (Ordering Unit 1piece)	1piece	5 pieces/box	10 pieces/box <sup>*)</sup> (Ordering Unit 1piece) Caulking(600ml)10pieces, Primer,brush,nozzle2pieces <small>*Holder set are sold separately</small>	60g/bottle	

\*1 The dedicated primer (part number B85AA or B85BB) will be shipped at the same time.

# Flat FT

Coating performance	Weather resistance	Installation
Hydrophilic Self-cleaning	Weather resistance grade ★	Installation Horizontal and Vertical

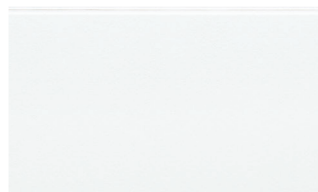

FW7493EK

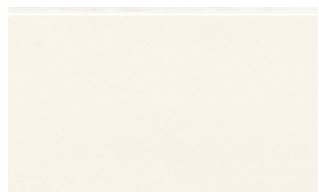

FW7494EK



FW74920EK

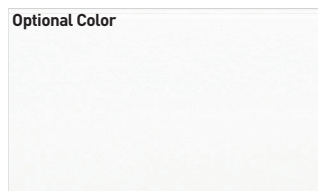

FW7491EK

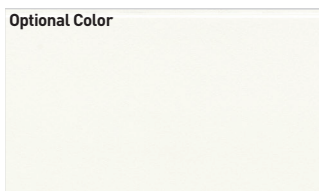

FW7492EK

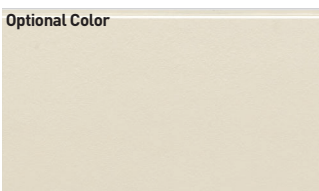

FW7495EK

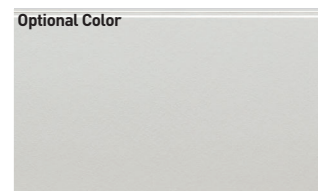

FW7497EK

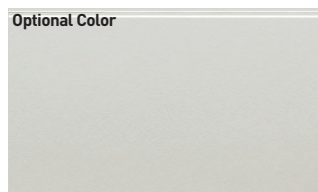

FW7496EK

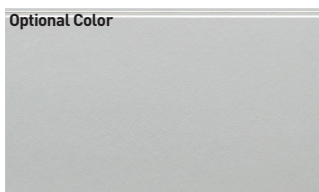

FW7498EK

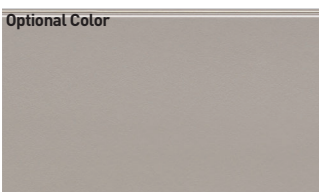

FW7499EK

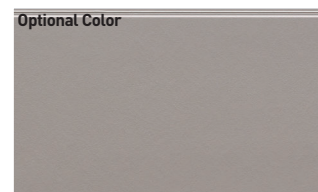

FW74910EK



FW74913EK

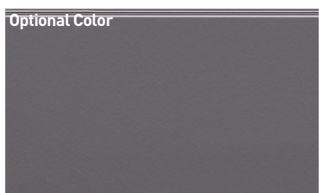

FW74918EK



FW74919EK



FW74916EK



FW74912EK



FW74915EK



FW74917EK

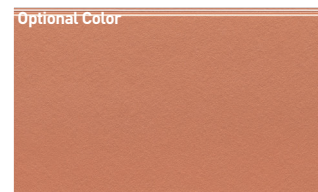

FW74911EK



FW74914EK

## Specifications

Size	16×455(exposed width)×3030mm	
Price	Optional Color	8,900JPY/piece 6,460JPY/m <sup>2</sup>
	FW7493EK/ FW7494EK/ FW74920EK	8,300JPY/piece 6,020JPY/m <sup>2</sup>
Number of panel per package	2pieces	
Coverage	1.38m <sup>2</sup> /piece	
Weight	Approx. 29kg/piece	

## Outside corner

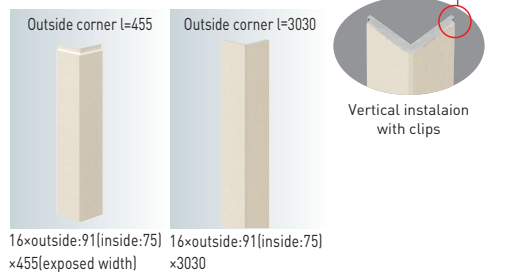

## Accessories list

Genuine accessories are required to install siding panels

Accessories		Outside corner l=455	Outside corner l=3030	Through Wall Flashing l=3030	Caulking (Holder set: B80E)	Repair Paint
Panel	FW7493EK	FWD7493EK	FWP7493EK	B22413058	B84303044	B93HB3064ANK
	FW7494EK	FWD7494EK	FWP7494EK	B2241W2	B84302491A	B93HB2551ANK
	FW74920EK	FWD74920EK	FWP74920EK	B2241W1	B84303045	B93HB3091CNK
Optional Color	FW7491EK	FWD7491EK	FWP7491EK	B22413058	B8430577	B93HB2669BNK
	FW7492EK	FWD7492EK	FWP7492EK	B2241W2	B8430577	B93HB2592BNK
	FW7495EK	FWD7495EK	FWP7495EK	B2241578	B8430746	B93HB746ANK
	FW7496EK	FWD7496EK	FWP7496EK	B2241557	B84301615	B93HB1765ANK
	FW7497EK	FWD7497EK	FWP7497EK	B2241557	B8430557	B93HB788BNK
	FW7498EK	FWD7498EK	FWP7498EK	B2241557	B8430580	B93HB1772ANK
	FW7499EK	FWD7499EK	FWP7499EK	B2241W4	B84301453	B93HB1453ANK
	FW74910EK	FWD74910EK	FWP74910EK	B2241W4	B84302503	B93HB2720BNK
	FW74911EK	FWD74911EK	FWP74911EK	B2241W1(Black)/ B2241W2(White)/ B2241W3(Brown)/ B2241W4(Gray)	B84303218	B93HB3329BNK
	FW74912EK	FWD74912EK	FWP74912EK		B84301781	B93HB1781BNK
	FW74913EK	FWD74913EK	FWP74913EK	B2241549	B84303212	B93HB3316ANK
	FW74914EK	FWD74914EK	FWP74914EK	B2241461	B84303005A	B93HB3015BNK
	FW74915EK	FWD74915EK	FWP74915EK	B2241549	B8430749A	B93HB749CNK
	FW74916EK	FWD74916EK	FWP74916EK	B2241462	B84301758A	B93HB747ENK
	FW74917EK	FWD74917EK	FWP74917EK	B22413114	B8430707C	B93HB707ANK
FW74918EK	FWD74918EK	FWP74918EK	B2241549	B8430743	B93HB743DNK	
FW74919EK	FWD74919EK	FWP74919EK	B2241W1	B8430719A	B93HB719CNK	
Price	4,200JPY/piece	19,300JPY/piece	3,200JPY/piece	6,600JPY/piece	2,900JPY/bottle	
Number of panel per package	10 pieces/box (Ordering Unit 1piece)	1piece	5 pieces/box	10 pieces/box <sup>*1</sup> (Ordering Unit 1piece) Caulking(600ml)10pieces, Primer,brush,nozzle2pieces <small>*Holder set are sold separately</small>	60g/bottle	

\*1 The dedicated primer (part number B85AA or B85BB) will be shipped at the same time.



Ceradir V 14  
Modern Stripe1  
HCW91556C

## Ceradir V 14

Ceramic Brick  
 Erde Flat  
 Oak  
 Kloof  
 Modern Stripe 5  
 Modern Stripe 1  
 Sottile

### ■ Joint Alignment & Connection Sections

#### Joint Alignment Across Joints

- To enhance the natural appearance of the design, the joint width intentionally varies.  
 In addition, the joints on both sides of the joint may be misaligned by approximately 3mm.
- The joint width varies to create a natural design expression.
- The joints on either side of the joint may be offset by around 3mm.

#### Connection Sections

A joint is placed every approx. 455mm in the vertical direction.  
 Depending on lighting conditions, sunlight, or viewing angle, subtle shadows or slight gaps may appear along the joint lines.

### ■ Performance List

item	unit	Ceradir V 14	note
		14mm thickness	
specific gravity	—	1.0*	Drying at 105°C for 24 hours
Water content	%	20 or under	JISA5422
Water absorption rate	%	50 or under	Water absorption 24h→105°C 24h
Bending Failure Load	N	785 or over	JISA5422
Impact resistance	—	Passed	JISA5422

\*These are our measured values.

# CeradirV14

14 mm thickness | CeradirV14

14×455×3000(mm) | 6,900JPY/piece 5,000JPY/m<sup>2</sup>

Hydrophilic  
Self-  
cleaning

Weather  
resistance grade  
★

## Ceramic Brick

Installation  
Horizontal



HCW2321GC



HCW2322GC



HCW2323GC



HCW2324GC



HCW2327GC

14×455×3030(mm) | 6,400JPY/piece 4,640JPY/m<sup>2</sup>

## Erde Flat

Installation  
Horizontal  
and  
Vertical

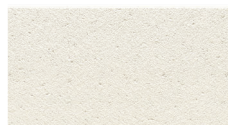

HCW2421GC



HCW2422GC



HCW2423GC



HCW2424GC

## Oak

Installation  
Horizontal  
and  
Vertical



HCW9141GC



HCW9142GC



HCW9143GC

## Kloof

Installation  
Horizontal



HCW1819GC



HCW18110GC



HCW18111GC

14 mm thickness | CeradirV14

14x455x3000(mm) | 5,800JPY/piece 4,210JPY/m<sup>2</sup>

Hydrophilic Self-cleaning  
Weather resistance grade ★

Modern Stripe5

Installation Horizontal and Vertical



HCW1567GC



HCW1568GC



HCW1569GC



HCW15610GC



HCW15614GC



HCW15615GC

Modern Stripe1

Installation Horizontal and Vertical

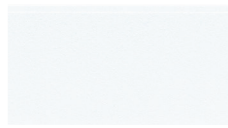

HCW9151GC



HCW9152GC



HCW9154GC



HCW9155GC



HCW9159GC



HCW91510GC



HCW91511GC



HCW91512GC

Sottile

Installation Horizontal and Vertical



HCW1111GC



HCW1112GC



HCW1119GC



HCW11110GC



HCW11124GC



HCW11126GC



HCW11127GC



HCW11128GC



HCW11131GC

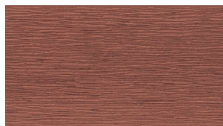

HCW11132GC



HCW11133GC

# Ceramic Brick

Coating performance	Weather resistance	Installation
Hydrophilic Self-cleaning	Weather resistance grade ★	Installation Horizontal



HCW2321GC



HCW2322GC



HCW2323GC



HCW2324GC



HCW2327GC

## Specifications

Size	14×455(exposed width)×3000mm
Price	<b>6,900JPY</b> /piece 5,000JPY/m <sup>2</sup>
Number of panel per package	2pieces
Coverage	1.37m <sup>2</sup> /piece
Weight	Approx. 20kg/piece

## Accessories list

Genuine accessories are required to install siding panels

Panel	Accessories				Repair Paint	
	Outside Metal Corner l=3030	T-shaped aluminum joiner	L-shaped aluminum joiner			
HCW2321GC	B211512	B36F2	B36KF2	B93HB2660D	—	
HCW2322GC	B211550	B36F4	B36KF4	B93HB2741A	B93HB1794B	
HCW2323GC	B211476	B36F4	B36KF4	B93HB2654A	B93HB2664A	
HCW2324GC	B211476	B36F3	B36KF3	B93HB2654A	B93HB654B	
HCW2327GC	B211W1	B36F1	B36KF1	B93HB669C	—	
Price	<b>4,800JPY</b> /piece	<b>4,200JPY</b> /piece	<b>3,900JPY</b> /piece	<b>2,900JPY</b> /bottle		
Number of packages	 5 pieces/box	15 pieces/box	15 pieces/box	60g/bottle		

# Erde Flat

Coating performance	Weather resistance	Installation
Hydrophilic Self-cleaning	Weather resistance grade ★	Installation Horizontal and Vertical

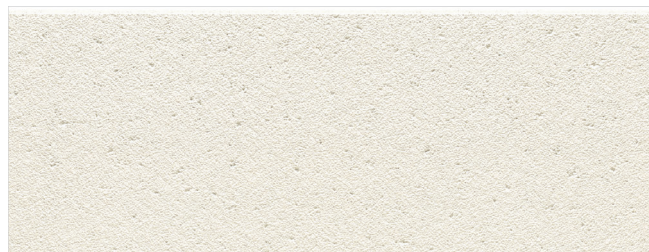

HCW2421GC

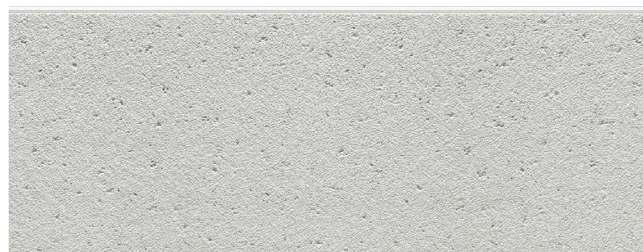

HCW2422GC



HCW2423GC

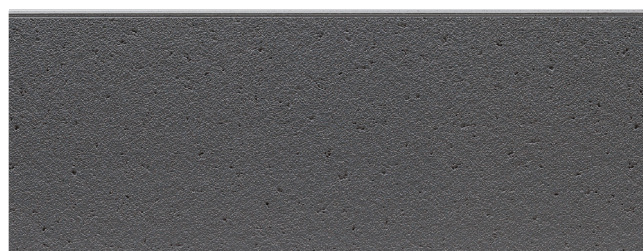

HCW2424GC

## Specifications

Size	14×455(exposed width)×3000mm
Price	<b>6,900JPY</b> /piece 5,000JPY/m <sup>2</sup>
Number of panel per package	2pieces
Coverage	1.37m <sup>2</sup> /piece
Weight	Approx. 20kg/piece

## Accessories list Genuine accessories are required to install siding panels

Accessories	Outside Metal Corner l=3030	T-shaped aluminum joiner	L-shaped aluminum joiner	Repair Paint
Panel				
HCW2421GC	B211W2	B36F2	B36KF2	B93HB2658D
HCW2422GC	B211557	B36F2	B36KF2	B93HB2498B
HCW2423GC	B211550	B36F4	B36KF4	B93HB2741C
HCW2424GC	B211549	B36F1	B36KF1	B93HB689F
Price	<b>4,800JPY</b> /piece	<b>4,200JPY</b> /piece	<b>3,900JPY</b> /piece	<b>2,900JPY</b> /bottle
Number of packages	 5 pieces/box	15 pieces/box	15 pieces/box	60g/bottle

# Oak

Coating performance	Weather resistance	Installation
Hydrophilic Self-cleaning	Weather resistance grade ★	Installation Horizontal



HCW9141GC



HCW9142GC



HCW9143GC

## Specifications

Size	14×455(exposed width)×3000mm
Price	<b>6,400JPY</b> /piece 4,640JPY/m <sup>2</sup>
Number of panel per package	2pieces
Coverage	1.37m <sup>2</sup> /piece
Weight	Approx. 20kg/piece

## Accessories list Genuine accessories are required to install siding panels

Panel	Accessories	Outside Metal Corner l=3030	T-shaped aluminum joiner	L-shaped aluminum joiner	Repair Paint
HCW9141GC		B211425	B36F4	B36KF4	B93HB1792D
HCW9142GC		B211459	B36F4	B36KF4	B93HB2687B
HCW9143GC		B211W3	B36F3	B36KF3	B93HB1714
Price		<b>4,800JPY</b> /piece	<b>4,200JPY</b> /piece	<b>3,900JPY</b> /piece	<b>2,900JPY</b> /bottle
Number of packages			15 pieces/box	15 pieces/box	60g/bottle
		5 pieces/box			

# Kloof

Coating performance	Weather resistance	Installation
Hydrophilic Self-cleaning	Weather resistance grade ★	Installation Horizontal



HCW1819GC



HCW18110GC



HCW18111GC

## Specifications

Size	14×455(exposed width)×3000mm
Price	<b>6,400JPY</b> /piece 4,640JPY/m <sup>2</sup>
Number of panel per package	2pieces
Coverage	1.37m <sup>2</sup> /piece
Weight	Approx. 19kg/piece

## Accessories list Genuine accessories are required to install siding panels

Panel	Accessories	Outside Metal Corner l=3030	T-shaped aluminum joiner	L-shaped aluminum joiner	Repair Paint
HCW1819GC		B211549	B36F3	B36KF3	B93HB689
HCW18110GC		B211512	B36F2	B36KF2	B93HB595B
HCW18111GC		B211459	B36F4	B36KF4	B93HB740A
Price		<b>4,800JPY</b> /piece	<b>4,200JPY</b> /piece	<b>3,900JPY</b> /piece	<b>2,900JPY</b> /bottle
Number of packages		 5 pieces/box	15 pieces/box	15 pieces/box	60g/bottle

# Modern Stripe 5

Coating performance	Weather resistance	Installation
Hydrophilic Self-cleaning	Weather resistance grade ★	Installation Horizontal and Vertical



HCW1567GC

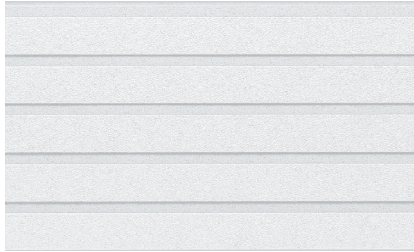

HCW1568GC



HCW1569GC



HCW15610GC



HCW15614GC



HCW15615GC

## Specifications

Size	14×455(exposed width)×3000mm
Price	<b>5,800JPY</b> /piece 4,210JPY/m <sup>2</sup>
Number of panel per package	2pieces
Coverage	1.37m <sup>2</sup> /piece
Weight	Approx. 20kg/piece

## Accessories list Genuine accessories are required to install siding panels

Panel	Accessories	Outside Metal Corner l=3030	T-shaped aluminum joiner	L-shaped aluminum joiner	Repair Paint
HCW1567GC		B211W1	B36F1	B36KF1	B93HB735
HCW1568GC		B2113058	B36F2	B36KF2	B93HB3058
HCW1569GC		B211557	B36F4	B36KF4	B93HB557
HCW15610GC		B2113057	B36F4	B36KF4	B93HB3057
HCW15614GC		B211550	B36F4	B36KF4	B93HB2741C
HCW15615GC		B211476	B36F4	B36KF4	B93HB2654A
Price		<b>4,800JPY</b> /piece	<b>4,200JPY</b> /piece	<b>3,900JPY</b> /piece	<b>2,900JPY</b> /piece
Number of packages		 5 pieces/box	15 pieces/box	15 pieces/box	60g/bottle

# Modern Stripe 1

Coating performance	Weather resistance	Installation
Hydrophilic Self-cleaning	Weather resistance grade ★	Installation Horizontal and Vertical

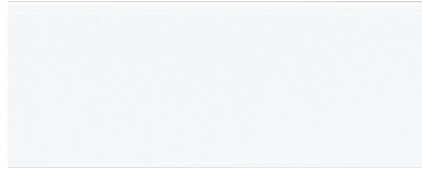

HCW9151GC

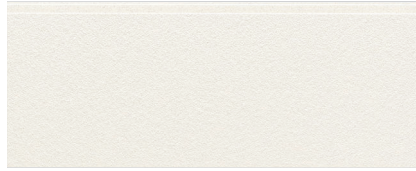

HCW9152GC



HCW9154GC



HCW9155GC



HCW9159GC



HCW91510GC



HCW91511GC



HCW91512GC

## Specifications

Size	14×455(exposed width)×3000mm
Price	<b>5,800JPY</b> /piece 4,210JPY/m <sup>2</sup>
Number of panel per package	2pieces
Coverage	1.37m <sup>2</sup> /piece
Weight	Approx. 20kg/piece



\*1 This pattern is a texture that blends well with the striped panels.

## Accessories list Genuine accessories are required to install siding panels

Accessories	Outside Metal Corner l=3030	T-shaped aluminum joiner	L-shaped aluminum joiner	Repair Paint
Panel				
HCW9151GC	B2113058	B36F2	B36KF2	B93HB3058
HCW9152GC	B211512	B36F4	B36KF4	B93HB428
HCW9154GC	B211460	B36F4	B36KF4	B93HB583
HCW9155GC	B211557	B36F4	B36KF4	B93HB557
HCW9159GC	B211550	B36F4	B36KF4	B93HB2741C
HCW91510GC	B211476	B36F4	B36KF4	B93HB2654A
HCW91511GC	B211W1	B36F1	B36KF1	B93HB735
HCW91512GC	B211549	B36F4	B36KF4	B93HB3284B
Price	<b>4,800JPY</b> /piece	<b>4,200JPY</b> /piece	<b>3,900JPY</b> /piece	<b>2,900JPY</b> /piece
Number of packages	 5 pieces/box	15 pieces/box	15 pieces/box	60g/bottle

# Sottile

Coating performance	Weather resistance	Installation
Hydrophilic Self-cleaning	Weather resistance grade ★	Installation Horizontal and Vertical



HCW1111GC



HCW1112GC

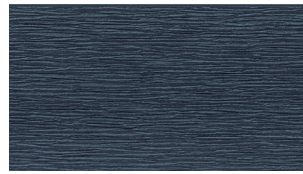

HCW1119GC



HCW11110GC



HCW11124GC



HCW11126GC



HCW11127GC



HCW11128GC



HCW11131GC



HCW11132GC



HCW11133GC

## Specifications

Size	14×455[Exposed width (length)]×3000
Price	<b>5,800JPY</b> /piece 4,210JPY/m <sup>2</sup>
Number of panel per package	2pieces
Coverage	1.37m <sup>2</sup> /piece
Weight	Approx. 20kg/piece

## Accessories list Genuine accessories are required to install siding panels

Panel	Accessories	Outside Metal Corner l=3030	T-shaped aluminum joiner	L-shaped aluminum joiner	Repair Paint
HCW1111GC		B211512	B36F4	B36KF4	B93HB428
HCW1112GC		B211427	B36F4	B36KF4	B93HB427
HCW1119GC		B211462	B36F1	B36KF1	B93HB462
HCW11110GC		B211460	B36F4	B36KF4	B93HB583
HCW11124GC		B211476	B36F3	B36KF3	B93HB476
HCW11126GC		B211468	B36F4	B36KF4	B93HB3043
HCW11127GC		B2113058	B36F2	B36KF2	B93HB3058
HCW11128GC		B2113057	B36F4	B36KF4	B93HB3057
HCW11131GC		B211550	B36F4	B36KF4	B93HB2741C
HCW11132GC		B211476	B36F4	B36KF4	B93HB2654A
HCW11133GC		B211W1	B36F1	B36KF1	B93HB735
Price		<b>4,800JPY</b> /piece	<b>4,200JPY</b> /piece	<b>3,900JPY</b> /piece	<b>2,900JPY</b> /piece
Number of packages		5 pieces/box	15 pieces/box	15 pieces/box	60g/bottle



# Narrow shaped outside corner

## Narrow shaped outside corner

Material: Coated galvanized steel



Narrow shaped outside corner for 18mm thickness panels brown



Narrow shaped outside corner for 16mm thickness panels gray



**Installation Procedure 1**  
Install the Narrow shaped outside corner.



**Installation Procedure 2**  
Cut a 45 degree angle at the siding edge. [Please use a tool which can cut a 45 degree angle at the siding edge.]



**Installation Procedure 3**  
Install siding panel.

Narrow shaped outside corner for 18mm thickness panels				
Color	black	white	brown	gray
Shape				
Item number	B21611W1	B21611W2	B21611W3	B21611W4
Price	8,900JPY/piece			
Number of panel per package	4 pieces/box			

Narrow shaped outside corner for 16mm thickness panels				
Color	black	white	brown	gray
Shape				
Item number	B2151W1	B2151W2	B2151W3	B2151W4
Price	8,900JPY/piece			
Number of panel per package	4 pieces/box			

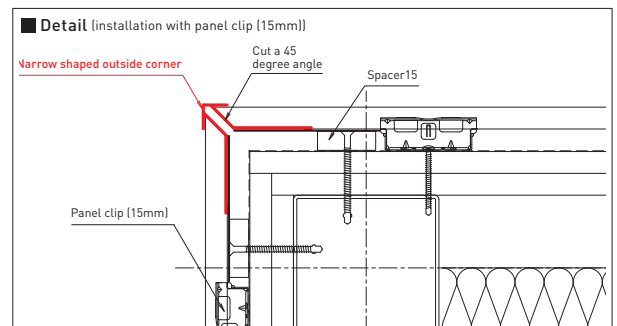

# W shaped outside corner

## W shaped outside corner

Material: Coated galvanized steel



W shaped outside corner for 18mm thickness panels brown



W shaped outside corner for 14mm thickness panels gray

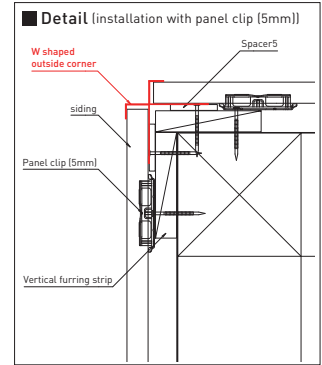

W shaped outside corner for 18mm thickness panels				
Color	black	white	brown	gray
Shape				
Item number	B21711W1	B21711W2	B21711W3	B21711W4
Price	11,400JPY/piece			
Number of panel per package	4 pieces/box			

W shaped outside corner for 16mm thickness panels				
Color	black	white	brown	gray
Shape				
Item number	B21721W1	B21721W2	B21721W3	B21721W4
Price	11,400JPY/piece			
Number of panel per package	4 pieces/box			

W shaped outside corner for 14mm thickness panels				
Color	black	white	brown	gray
Shape				
Item number	B21731W1	B21731W2	B21731W3	B21731W4
Price	7,000JPY/piece			
Number of panel per package	4 pieces/box			

# Horizontal Application (for 5mm panel clip)

Products

Legerair Filltect Neorock Excellage Ceradier

Clip(5mm)				
	Panel Clip		Corner Clip	Starter bar for horizontal application
Shape				
Item number	<b>B1005</b>	<b>B1305</b>	<b>B10053</b>	<b>B101052</b>
Price	11,200JPY/bag	12,000JPY/bag	6,400JPY/bag	2,100JPY/piece
Number of panel per package	70 pieces/bag		50 pieces/bag	4 pieces/box
Material	Hot-dip zinc-aluminum magnesium alloy coated steel		Hot-dip zinc-aluminum magnesium alloy coated steel	Hot-dip zinc-aluminum magnesium alloy coated steel

Clip Fixing Component					
	Clip Screw25 (for wood substructure)	Clip Screw35 (for wood substructure)	Clip Screw19 (for steel substructure)	Clip Screw16 (for steel substructure)	Clip Screw30 (for steel substructure)
Shape					
Item number	<b>RY8830</b>	<b>B881135</b>	<b>RY8840</b>	<b>B885116</b>	<b>B885130</b>
Price	10,500JPY/box	10,500JPY/box	13,600JPY/box	15,100JPY/box	19,000JPY/box
Number of panel per package	500 pieces/box	500 pieces/box	500 pieces/box	500 pieces/box	500 pieces/box
Material	Stainless Steel	Stainless Steel	Stainless Steel	Stainless Steel	Stainless Steel

Spacer		
	Spacer5 (for openings and eaves)	Spacer2 (for land adjustment)
Shape		
Item number	<b>RY82S05</b>	<b>RY82S02</b>
Price	21,700JPY/box	18,000JPY/box
Number of panel per package	20 pieces/box	20 pieces/box
Material	Polypropylene	Polypropylene

Flashing		
Internal Flashing	Sill Flashing50	Through Wall Flashing For 18/16/15mm thickness
<b>RCILK</b>	black <b>B238W1</b> white <b>B238W2</b> brown <b>B238W3</b> gray(metalic) <b>B238W4</b>	
1,400JPY/piece	3,200JPY/piece	3,200JPY/piece
20 pieces/box	5 pieces/box	5 pieces/box
Coated galvanized steel	Coated galvanized steel	Coated galvanized steel

Soffit Flashing		Repair Component
	For 21/18mm thickness	Repair Putty
Shape		
	black <b>B257W1</b> white <b>B257W2</b> brown <b>B257W3</b> gray <b>B257W4</b>	<b>B4901</b>
Price	4,800JPY/piece	3,700JPY/piece
Number of panel per package	5 pieces/box	1 pieces/350g
Material	Coated galvanized steel	Acrylic emulsion
	For 16/15mm thickness	
Shape		
	black <b>B256W1</b> white <b>B256W2</b> brown <b>B256W3</b> gray <b>B256W4</b>	
Price	4,200JPY/piece	
Number of panel per package	5 pieces/box	
Material	Coated galvanized steel	

Long Clip	
<b>B10055</b>	
<b>3,800 JPY/piece</b>	
6 pieces/box	
Hot-dip zinc-aluminum magnesium alloy coated steel	

Face Nail / Screw				
Face Nail50(for wood substructure)	Face Nail45(for wood substructure)	Face Screw50 (for steel substructure)	Face Screw45 (for steel substructure)	Face Screw35 (for steel substructure)
For 21/18mm thickness	For 16/15mm thickness			
<b>B8750R400</b>	<b>B8745R400</b>	<b>B88501</b>	<b>B885245</b>	<b>B8852135</b>
<b>790 JPY/bag</b>	<b>580 JPY/bag</b>	<b>9,500 JPY/box</b>	<b>15,600 JPY/box</b>	<b>14,000 JPY/box</b>
40 pieces/bag	40 pieces/bag	200 pieces/box	300 pieces/box	300 pieces/box
Stainless Steel	Stainless Steel	Stainless Steel	Stainless Steel	Stainless Steel

Joint Component			
Metal Caulking Joiner			
For 15mm thickness	For 15mm thickness(one-side)	For 16mm or more thickness	For 16mm or more thickness(one-side)
<b>B2715</b>	<b>B2715K</b>	<b>B2721</b>	<b>B2718K</b>
<b>1,900 JPY/piece</b>	<b>1,800 JPY/piece</b>	<b>2,000 JPY/piece</b>	<b>2,000 JPY/piece</b>
15 pieces/box	15 pieces/box	15 pieces/box	15 pieces/box
Hot-dip zinc-aluminum magnesium alloy coated steel	Hot-dip zinc-aluminum magnesium alloy coated steel	Hot-dip zinc-aluminum magnesium alloy coated steel	Hot-dip zinc-aluminum magnesium alloy coated steel

Joint Component	
T-shaped joiner	L-shaped joiner
black <b>B3616F1</b> white <b>B3616F2</b> brown <b>B3616F3</b> dark stainless <b>B3616F4</b>	black <b>B3616KF1</b> white <b>B3616KF2</b> brown <b>B3616KF3</b> dark stainless <b>B3616KF4</b>
<b>6,500 JPY/piece</b>	<b>6,100 JPY/piece</b>
15 pieces/box	15 pieces/box
Aluminum	Aluminum

Waterproof Component	
Waterproof Sealer	Waterproof Sealer for Filteck
<b>RM875</b>	<b>LTKBM3103C</b>
<b>3,600 JPY/bottle</b>	<b>23,300 JPY/bottle</b>
1 bottle/100g	1 bottle/1liter
—	—

# Virtical Application (for 5mm panel clip)

Products

Filltect

Neorock

Excellage



Ceradier



Clip(5mm)					
	Panel Clip		Corner Clip	Starter bar for vertical application	
	t=0.8mm		t=0.8mm	For 16/15mm thickness	For 18mm thickness
Shape					
Item number	<b>B1005</b>	<b>B1305</b>	<b>RE10058</b>	<b>B130571</b>	<b>B1320572</b>
Price	<b>11,200JPY/bag</b>	<b>12,000JPY/bag</b>	<b>4,400JPY/bag</b>	<b>6,500JPY/piece</b>	<b>5,900JPY/piece</b>
Number of panel per package	70 pieces/bag		34 pieces/bag	5 pieces/box	5 pieces/box
Material	Hot-dip zinc-aluminum magnesium alloy coated steel		Hot-dip zinc-aluminum magnesium alloy coated steel	Hot-dip zinc-aluminum magnesium alloy coated steel	Hot-dip zinc-aluminum magnesium alloy coated steel

Face Nail / Screw					
	Face Nail50(for wood substructure)	Face Nail45(for wood substructure)	Face Screw50 (for steel substructure)	Face Screw45 (for steel substructure)	Face Screw60 (for steel substructure)
	For 18mm thickness	For 16/15mm thickness			
Shape			 Sub Structure thickness :1.6 to 2.3mm	 Sub Structure thickness :1.2mm	 Sub Structure thickness :1.2mm
Item number	<b>B8750R400</b>	<b>B8745R400</b>	<b>B88501</b>	<b>B885245</b>	<b>B885260</b>
Price	<b>790JPY/bag</b>	<b>580JPY/bag</b>	<b>9,500JPY/box</b>	<b>15,600JPY/box</b>	<b>12,500JPY/box</b>
Number of panel per package	40 pieces/bag	40 pieces/bag	200 pieces/box	300 pieces/box	200 pieces/box
Material	Stainless Steel	Stainless Steel	Stainless Steel	Stainless Steel	Stainless Steel

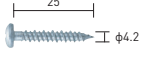
Spacer			Flashing	
	Spacer5 (for openings and eaves)	Spacer2 (for land adjustment)	Internal Flashing	Sill Flashing 50
	Shape			
Item number	<b>RY82S05</b>	<b>RY82S02</b>	<b>RCILK</b>	<b>B238W1</b> black <b>B238W2</b> white <b>B238W3</b> brown <b>B238W4</b> gray(metalic)
Price	<b>21,700JPY/box</b>	<b>18,000JPY/box</b>	<b>1,400JPY/piece</b>	<b>3,200JPY/piece</b>
Number of panel per package	20 pieces/box	20 pieces/box	20 pieces/box	5 pieces/box
Material	Polypropylene	Polypropylene	Coated galvanized steel	Coated galvanized steel

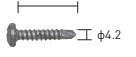
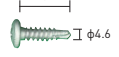
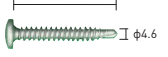
Repair Component		Waterproof Component	
	Repair Putty	Waterproof Sealer	Waterproof Sealer for Filltect
	Shape		
Item number	<b>B4901</b>	<b>RM875</b>	<b>LTKBM3103C</b>
Price	<b>3,700JPY/piece</b>	<b>3,600JPY/bottle</b>	<b>23,300JPY/bottle</b>
Number of panel per package	1 pieces/350g	1 bottle/100g	1 bottle/1liter
Material	Acrylic emulsion	—	—

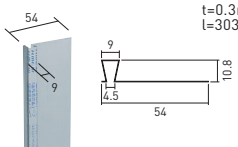
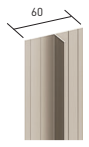
		Clip Fixing Component				
Corner cap for starter bar		Clip Screw25 (for wood substructure)	Clip Screw35 (for wood substructure)	Clip Screw19 (for steel substructure)	Clip Screw16 (for steel substructure)	Clip Screw30 (for steel substructure)
				 Sub Structure thickness :1.6 to 2.3mm	 Sub Structure thickness :1.2mm	 Sub Structure thickness :1.2mm
<b>B293W1D</b>		<b>RY8830</b>	<b>B881135</b>	<b>RY8840</b>	<b>B885116</b>	<b>B885130</b>
3,900JPY/bag		10,500JPY/box	10,500JPY/box	13,600JPY/box	15,100JPY/box	19,000JPY/box
10 pieces/bag		500 pieces/box	500 pieces/box	500 pieces/box	500 pieces/box	500 pieces/box
Coated galvanized steel		Stainless Steel	Stainless Steel	Stainless Steel	Stainless Steel	Stainless Steel

Joint Component		
Metal Caulking Joiner(one-side)	T-shaped joiner	L-shaped joiner
 t=0.3mm l=3030mm	 t=1.2mm l=3000mm	 t=1.2mm l=3000mm
black B3616F1 white B3616F2 brown B3616F3 dark stainless B3616F4		black B3616KF1 white B3616KF2 brown B3616KF3 dark stainless B3616KF4
<b>B2715K</b>		
1,800JPY/piece	6,500JPY/piece	6,100JPY/piece
15 pieces/box	15 pieces/box	15 pieces/box
Hot-dip zinc-aluminum magnesium alloy coated steel	Aluminum	Aluminum

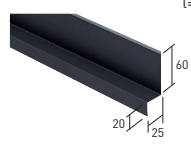
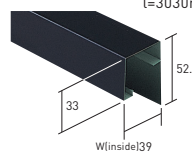
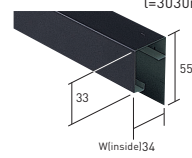
		Soffit Flashing	
Through Wall Flashing For 18/16/15mm thickness		For 21/18mm thickness	For 16/15mm thickness
 t=0.3mm l=3030mm		 t=0.35mm l=3030mm	 t=0.35mm l=3030mm
		black B257W1 white B257W2 brown B257W3 gray B257W4	black B256W1 white B256W2 brown B256W3 gray B256W4
<b>3,200JPY/piece</b>		<b>4,800JPY/piece</b>	<b>4,200JPY/piece</b>
5 pieces/box		5 pieces/box	5 pieces/box
Coated galvanized steel		Coated galvanized steel	Coated galvanized steel

# Horizontal Application (for 15mm panel clip)

Products

Legerair

Filltect

Neorock

Excellage

Ceradier

Clip(15mm)				
	Panel Clip	Corner Clip	Starter bar for horizontal application	
Shape				
Item number	<b>B10115</b>	<b>B101153</b>	<b>B101152</b>	
Price	<b>5,800JPY/bag</b>	<b>3,000JPY/bag</b>	<b>3,900JPY/piece</b>	
Number of panel per package	30 pieces/bag	20 pieces/bag	4 pieces/box	
Material	Hot-dip zinc-aluminum magnesium alloy coated steel	Hot-dip zinc-aluminum magnesium alloy coated steel	Hot-dip zinc-aluminum magnesium alloy coated steel	

Clip Fixing Component				
	Clip Screw25 (for wood substructure)	Clip Screw35 (for wood substructure)	Clip Screw55 (for wood substructure)	Clip Screw19 (for steel substructure)
Shape				 Sub Structure thickness :1.6 to 2.3mm
Item number	<b>RY8830</b>	<b>B881135</b>	<b>B88553</b>	<b>RY8840</b>
Price	<b>10,500JPY/box</b>	<b>10,500JPY/box</b>	<b>9,200JPY/box</b>	<b>13,600JPY/box</b>
Number of panel per package	500 pieces/box	500 pieces/box	200 pieces/box	500 pieces/box
Material	Stainless Steel	Stainless Steel	Stainless Steel	Stainless Steel

Face Nail / Screw					
	Face Nail65 (for wood substructure) 21/For 18/16/15mm thickness	Face Screw60 (for steel substructure) For 21mm thickness	Face Screw50 (for steel substructure) For 18/16/15mm thickness	Face Screw45 (for steel substructure)	Face Screw60 (for steel substructure)
Shape					
Item number	<b>B8765R400</b>	<b>B8860</b>	<b>B88501</b>	<b>B885245</b>	<b>B885260</b>
Price	<b>1,250JPY/bag</b>	<b>14,900JPY/box</b>	<b>9,500JPY/box</b>	<b>15,600JPY/box</b>	<b>12,500JPY/box</b>
Number of panel per package	40 pieces/bag	200 pieces/box	200 pieces/box	300 pieces/box	200 pieces/box
Material	Stainless Steel	Stainless Steel	Stainless Steel	Stainless Steel	Stainless Steel

Flashing			Soffit Flashing		
	Internal Flashing	Sill Flashing 50	For 21/18mm thickness	For 16/15mm thickness	
Shape					
Item number	<b>RCILK</b>	black <b>B238W1</b> white <b>B238W2</b> brown <b>B238W3</b> gray(metalic) <b>B238W4</b>	black <b>B257W1</b> white <b>B257W2</b> brown <b>B257W3</b> gray <b>B257W4</b>	black <b>B256W1</b> white <b>B256W2</b> brown <b>B256W3</b> gray <b>B256W4</b>	
Price	<b>1,400JPY/piece</b>	<b>3,200JPY/piece</b>	<b>4,800JPY/piece</b>	<b>4,200JPY/piece</b>	
Number of panel per package	20 pieces/box	5 pieces/box	5 pieces/box	5 pieces/box	
Material	Coated galvanized steel	Coated galvanized steel	Coated galvanized steel	Coated galvanized steel	

Long clip	
<b>B10155</b>	
4,000JPY/piece	
6 pieces/box	
Hot-dip zinc-aluminum magnesium alloy coated steel	

Clip Screw16 (for steel substructure)	Clip Screw30 (for steel substructure)
Sub Structure thickness :1.2mm	Sub Structure thickness :1.2mm
<b>B885116</b>	<b>B885130</b>
15,100JPY/box	19,000JPY/box
500 pieces/box	500 pieces/box
Stainless Steel	Stainless Steel

Spacer	
Spacer15 (for openings and eaves)	Spacer2 (for land adjustment)
<b>RY82S15</b>	<b>RY82S02</b>
15,200JPY/box	18,000JPY/box
6 pieces/box	20 pieces/box
Polypropylene	Polypropylene

Joint Component	
Metal Caulking Joiner	
For 15mm thickness	For 15mm thickness(one-side)
<b>B2716</b>	<b>B2716K</b>
3,100JPY/piece	3,100JPY/piece
15 pieces/box	15 pieces/box
Hot-dip zinc-aluminum magnesium alloy coated steel	Hot-dip zinc-aluminum magnesium alloy coated steel

Joint Component	
Metal Caulking Joiner	
For 16mm or more thickness	For 16mm or more thickness(one-side)
<b>B2722</b>	<b>B2719K</b>
3,400JPY/piece	3,500JPY/piece
15 pieces/box	15 pieces/box
Hot-dip zinc-aluminum magnesium alloy coated steel	Hot-dip zinc-aluminum magnesium alloy coated steel

Repair Component	Waterproof Component	
Repair Putty	Waterproof Sealer	Waterproof Sealer for Filtect
<b>B4901</b>	<b>RM875</b>	<b>LTKBM3103C</b>
3,700JPY/piece	3,600JPY/bottle	23,300JPY/bottle
1 pieces/350g	1 bottle/100g	1 bottle/1liter
Acrylic emulsion	—	—

# Virtical Application (for 15mm panel clip)



Products



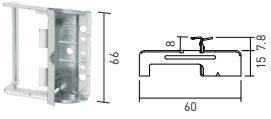
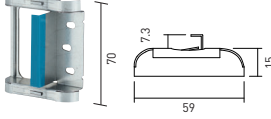

Filltect

Neorock



Excellage

Ceradier

Clip(15mm)			
	Panel Clip	Corner Clip	Starter bar for vertical application
			For 16/15mm thickness
Shape	 t=0.8mm 66, 60, 15 7.8	 t=0.8mm 70, 7.3, 15, 59	 t=0.8mm l=3030mm 36, 38.6
Item number	<b>B10115</b>	<b>RE10158</b>	<b>B1321571</b>
Price	5,800JPY/bag	8,500JPY/bag	5,600JPY/piece
Number of panel per package	30 pieces/bag	34 pieces/bag	5 pieces/box
Material	Hot-dip zinc-aluminum magnesium alloy coated steel	Hot-dip zinc-aluminum magnesium alloy coated steel	Hot-dip zinc-aluminum magnesium alloy coated steel

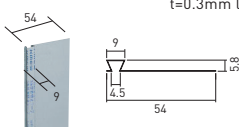
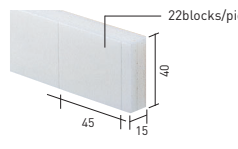
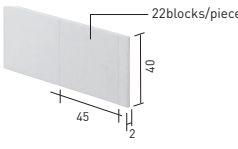
Clip Fixing Component					
	Clip Screw25 (for wood substructure)	Clip Screw35 (for wood substructure)	Clip Screw19 (for steel substructure)	Clip Screw16 (for steel substructure)	Clip Screw30 (for steel substructure)
Shape	 25, φ4.2	 35, φ4.1	 19, φ4.2 Sub Structure thickness :1.6 to 2.3mm	 16, φ4.6 Sub Structure thickness :1.2mm	 30, φ4.6 Sub Structure thickness :1.2mm
Item number	<b>RY8830</b>	<b>B881135</b>	<b>RY8840</b>	<b>B885116</b>	<b>B885130</b>
Price	10,500JPY/box	10,500JPY/box	13,600JPY/box	15,100JPY/box	19,000JPY/box
Number of panel per package	500 pieces/box	500 pieces/box	500 pieces/box	500 pieces/box	500 pieces/box
Material	Stainless Steel	Stainless Steel	Stainless Steel	Stainless Steel	Stainless Steel

Joint Component		Spacer	
	Metal Caulking Joiner(one-side)	Spacer15 (for openings and eaves)	Spacer2 (for land adjustment)
Shape	 t=0.3mm l=3030mm 54, 9, 4.5, 1.25	 22blocks/piece l=1000mm, 45, 15, 40	 22blocks/piece l=1000mm, 45, 2, 40
Item number	<b>B2713K</b>	<b>RY82S15</b>	<b>RY82S02</b>
Price	1,570JPY/piece	15,200JPY/box	18,000JPY/box
Number of panel per package	15 pieces/box	6 pieces/box	20 pieces/box
Material	Hot-dip zinc-aluminum magnesium alloy coated steel	Polypropylene	Polypropylene

Repair Component		Waterproof Component	
	Repair Putty	Waterproof Sealer	Waterproof Sealer for Filltect
Shape			
Item number	<b>B4901</b>	<b>RM875</b>	<b>LTKBM3103C</b>
Price	3,700JPY/piece	3,600JPY/bottle	23,300JPY/bottle
Number of panel per package	1 pieces/350g	1 bottle/100g	1 bottle/1liter
Material	Acrylic emulsion	—	—

Starter bar for vertical application		Corner cap for starter bar
For 18mm thickness		
<b>B1321572</b>		<b>B291W1D</b>
5,900JPY/piece		3,900JPY/bag
5 pieces/box		10 pieces/bag
Hot-dip zinc-aluminum magnesium alloy coated steel		Coated galvanized steel

Face Nail / Screw			
Face Nail65(for wood substructure)	Face Screw50(for steel substructure)	Face Screw45 (for steel substructure)	Face Screw60 (for steel substructure)
For 18/16/15mm thickness	For 18/16/15mm thickness		
	 Sub Structure thickness :1.6 to 2.3mm	 Sub Structure thickness :1.2mm	 Sub Structure thickness :1.2mm
<b>B8765R400</b>	<b>B88501</b>	<b>B885245</b>	<b>B885260</b>
1,250JPY/bag	9,500JPY/box	15,600JPY/box	12,500JPY/box
40 pieces/bag	200 pieces/box	300 pieces/box	200 pieces/box
Stainless Steel	Stainless Steel	Stainless Steel	Stainless Steel

Flashing	
Internal Flashing	Sill Flashing 50
 t=0.35mm l=3030mm	 t=0.35mm l=3030mm
<b>RCILK</b>	black <b>B238W1</b> white <b>B238W2</b> brown <b>B238W3</b> gray(metalic) <b>B238W4</b>
1,400JPY/piece	3,200JPY/piece
20 pieces/box	5 pieces/box
Coated galvanized steel	Coated galvanized steel



Soffit Flashing	
For 21/18mm thickness	For 16/15mm thickness
 t=0.35mm l=3030mm	 t=0.35mm l=3030mm
black <b>B257W1</b> white <b>B257W2</b> brown <b>B257W3</b> gray <b>B257W4</b>	black <b>B256W1</b> white <b>B256W2</b> brown <b>B256W3</b> gray <b>B256W4</b>
4,800JPY/piece	4,200JPY/piece
5 pieces/box	5 pieces/box
Coated galvanized steel	Coated galvanized steel

# Horizontal/Vertical Application (for 5mm panel clip)

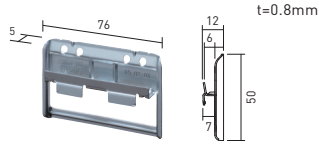
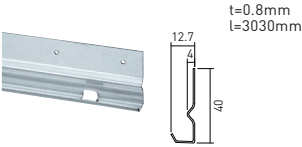
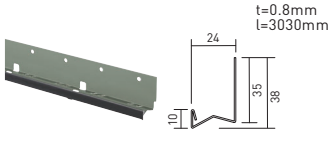

Products

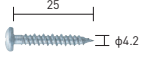
Ceradier V14

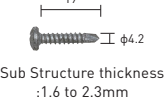
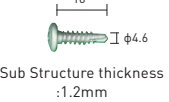
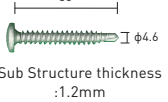

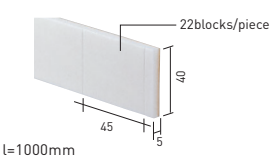
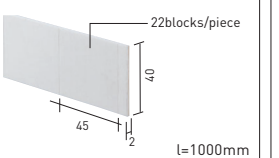
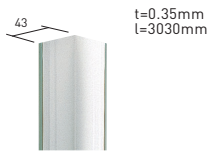
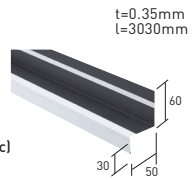
Clip(5mm)				
	Panel Clip	Starter bar for horizontal application	Starter bar for vertical application	
Shape				
Item number	<b>B1205</b>	<b>B101052</b>	<b>B12057</b>	
Price	<b>12,700JPY/bag</b>	<b>2,100JPY/piece</b>	<b>4,100JPY/piece</b>	
Number of panel per package	70 pieces/bag	4 pieces/box	5 pieces/box	
Material	Hot-dip zinc-aluminum magnesium alloy coated steel	Hot-dip zinc-aluminum magnesium alloy coated steel	Hot-dip zinc-aluminum magnesium alloy coated steel	

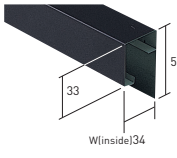
Clip Fixing Component					
	Clip Screw25 (for wood substructure)	Clip Screw35 (for wood substructure)	Clip Screw19 (for steel substructure)	Clip Screw16 (for steel substructure)	Clip Screw30 (for steel substructure)
Shape					
Item number	<b>RY8830</b>	<b>B881135</b>	<b>RY8840</b>	<b>B885116</b>	<b>B885130</b>
Price	<b>10,500JPY/box</b>	<b>10,500JPY/box</b>	<b>13,600JPY/box</b>	<b>15,100JPY/box</b>	<b>19,000JPY/box</b>
Number of panel per package	500 pieces/box	500 pieces/box	500 pieces/box	500 pieces/box	500 pieces/box
Material	Stainless Steel	Stainless Steel	Stainless Steel	Stainless Steel	Stainless Steel

Spacer			Flashing	
	Spacer5 (for openings and eaves)	Spacer2 (for land adjustment)	Internal Flashing	Sill Flashing50
Shape				
Item number	<b>RY82S05</b>	<b>RY82S02</b>	<b>RCILK</b>	
Price	<b>21,700JPY/box</b>	<b>18,000JPY/box</b>	<b>1,400JPY/piece</b>	<b>3,200JPY/piece</b>
Number of panel per package	20 pieces/box	20 pieces/box	20 pieces/box	5 pieces/box
Material	Polypropylene	Polypropylene	Coated galvanized steel	Coated galvanized steel

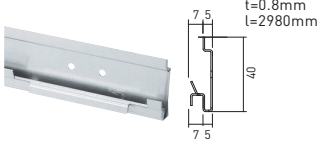
Flashing		Repair Component		Waterproof Component	
	Soffit flashing		Repair Putty		Waterproof Sealer
Shape	black B256W1 white B256W2 brown B256W3 gray B256W4 				
Price	<b>4,200JPY/piece</b>		<b>3,700JPY/piece</b>		<b>3,600JPY/bottle</b>
Number of panel per package	5 pieces/box		1 pieces/350g		1 bottle/100g
Material	Coated galvanized steel		Acrylic emulsion		—

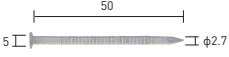
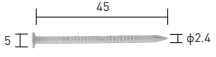
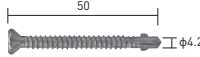
	Corner cap for starter bar	Long clip
		
	<b>B291W1D</b>	<b>B12055</b>
	3,500JPY/bag	6,900JPY/piece
	10 pieces/bag	6 pieces/box
	Coated galvanized steel	Hot-dip zinc-aluminum magnesium alloy coated steel

Face Nail / Screw			
Face Nail50(for wood substructure)	Face Nail45(for wood substructure)	Face Screw50 (for steel substructure)	Face Screw35 (for steel substructure)
For 21/18mm thickness	For 16/15mm thickness		
		 Sub Structure thickness :1.6 to 2.3mm	 Sub Structure thickness :1.2mm
<b>B8750R400</b>	<b>B8745R400</b>	<b>B88501</b>	<b>B8852135</b>
790JPY/bag	580JPY/bag	9,500JPY/box	14,000JPY/box
40 pieces/bag	40 pieces/bag	200 pieces/box	300 pieces/box
Stainless Steel	Stainless Steel	Stainless Steel	Stainless Steel

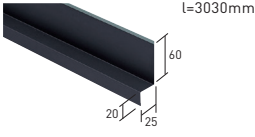
	Metal outside corner	Through wall flashing
		
	<b>B211***</b>	<b>B224***</b>
	4,800JPY/piece	3,200JPY/piece
	5 pieces/box	5 pieces/box
	Coated galvanized steel	Coated galvanized steel

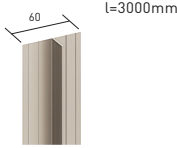
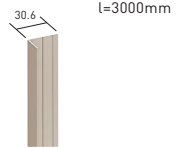
Joint Component	
T-shaped joiner	L-shaped joiner
black <b>B36F1</b> white <b>B36F2</b> brown <b>B36F3</b> dark stainless <b>B36F4</b>	black <b>B36KF1</b> white <b>B36KF2</b> brown <b>B36KF3</b> dark stainless <b>B36KF4</b>
	
<b>4,200JPY/piece</b>	<b>3,900JPY/piece</b>
15 pieces/box	15 pieces/box
Aluminum	Aluminum



**KMEW Co.,Ltd.**

Head office: 13F, Crystal Tower Bldg.,  
1-2-27 Shiromi, Chuo-ku, Osaka, Japan