

# Facade

2026 | 04 |



Products

Legerair / FLAT DESIGN PANEL / Neorock Photocatalytic Ceramic Coating /  
 FilltectN Photocatalytic Ceramic Coating / FilltectE Photocatalytic Ceramic Coating /  
 Excellage Photocatalytic Ceramic Coating



Dirt is decomposed  
by sunlight

### Decomposition Power

Dirt is decomposed by the sun (Ultraviolet Rays), weakening adhesion.

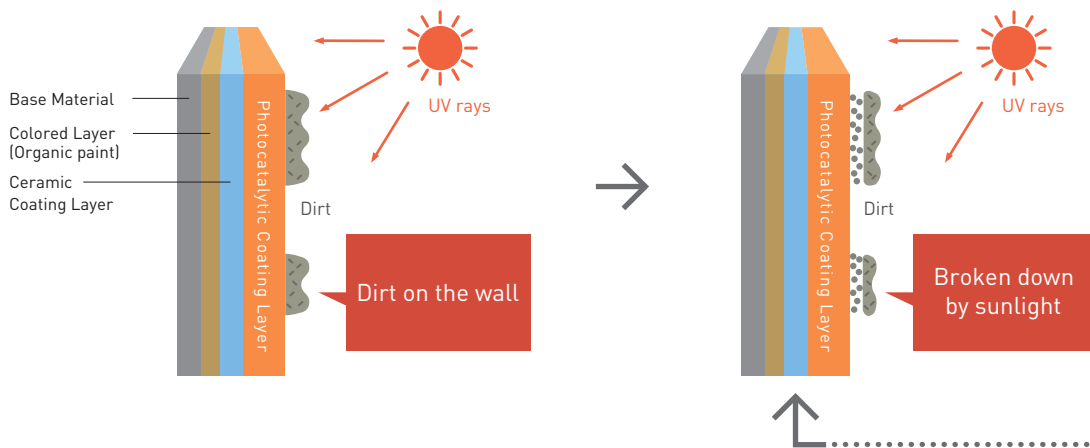

A home that is eco-friendly

### Air-purifying Function

Photocatalytic coat decomposes pollutants in the air and exhaust gas (NOx and SOx) into clean air .

The air purification capability of Photocatalytic coat of 165m<sup>2</sup> is worth 12 poplars.

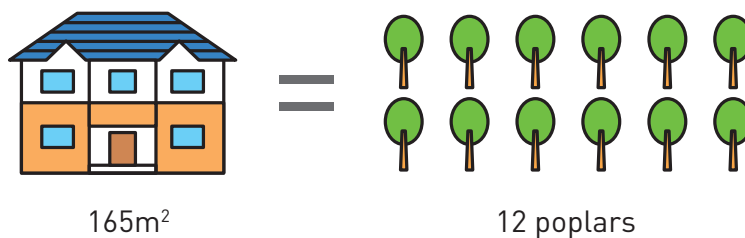

\*Assuming a poplar tree's air purifying capability (NO2) is 0.57g / day

Compatibility with water allows for easy cleaning.

## Super Hydrophilic Property

Due to the extreme compatibility with water, rainwater rinses off dirt.

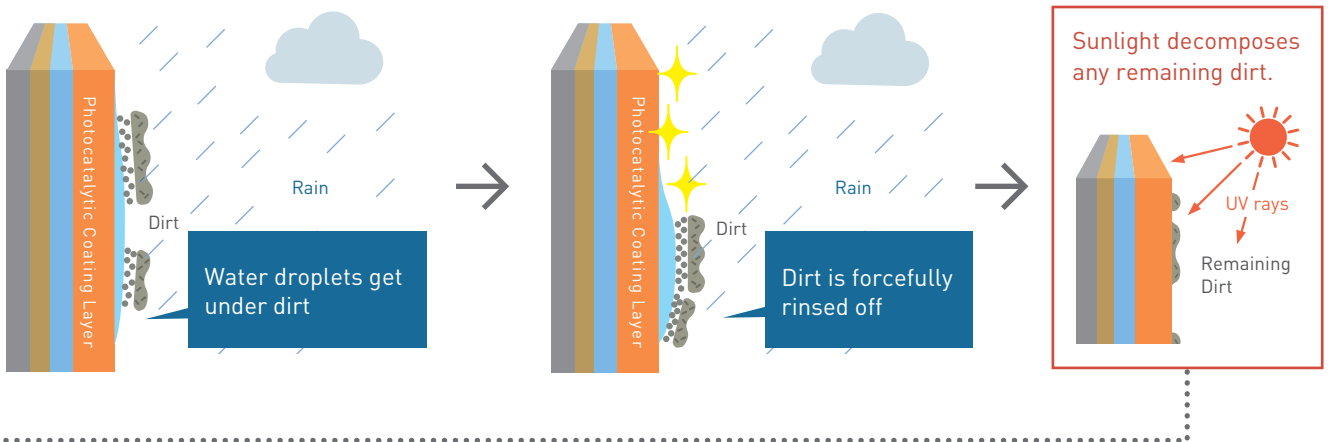

The ceramic coating layer offers strong protection against fading and sunburning

## Super Weather Resistance

The double effects of the inorganic resin and the inorganic UV absorber protects against over time and cuts UV rays.

### Point 1: Inorganic resin

The main framework is 100% inorganic with bonds that are strengthened by UV energy to prevent deterioration over time.

■ Molecular structure diagram

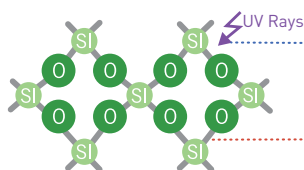

Bonds are not easily broken

Molecular Bonds

413 KJ / mol  
Kilo joules per mole

443KJ / mol

Increased strength from UV energy to prevent bonds from being easily broken

### Point 2: Inorganic UV absorber

The inorganic construction helps prevent deterioration and is able to cut UV rays.



Products

Neorock Hydrophilic coating / Excellage Hydrophilic coating /  
FilltectN Hydrophilic coating / FilltectE Hydrophilic coating /  
Ceradir Hydrophilic coating



Compatibility with water  
allows for easy cleaning.

Washed away by rainwater. Water gets on the dirt and washes the dirt away

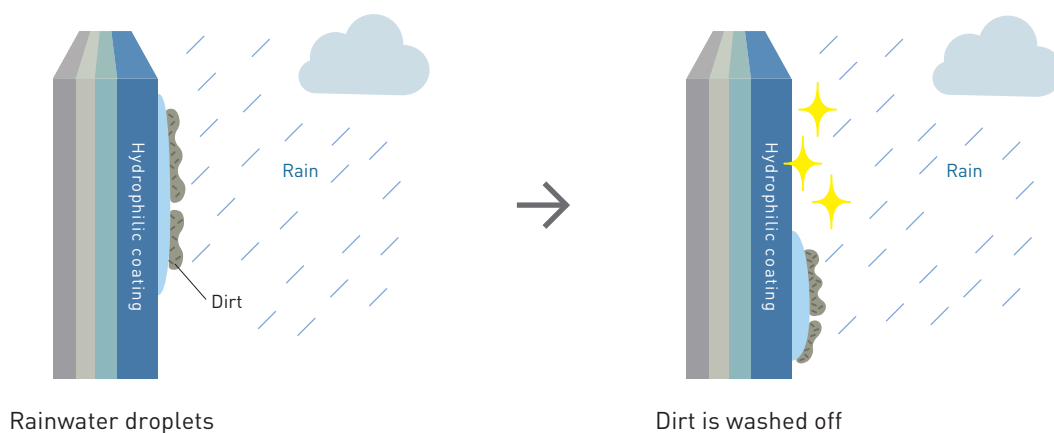

Advanced hydrophilic coating technology helps wash away dirt accumulated on the panel with rainwater. After panel being cleaned with rainwater from dirt, moisture remains on the hydrophilic surface. The color coating is strongly protected from moisture.

## Hydrophilic

The panel structure is formed from the substrate, base paint protective clear coating and hydrophilic coating.

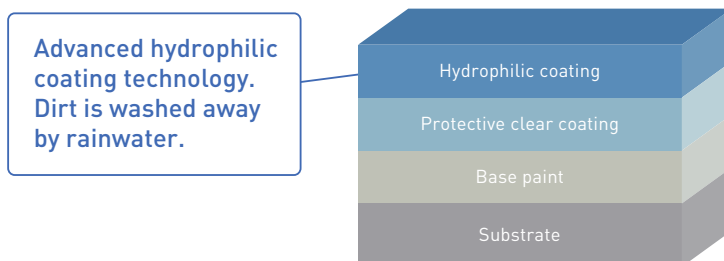



21 mm thickness | Legerair

21×455×3030(mm) | 14,900JPY/piece 10,810JPY/m<sup>2</sup>

Photocatalytic  
Self-  
cleaning

Weather  
resistance grade  
★★★

### Peerless Stone

Installation  
Horizontal



AH5931U



AH5932U



AH5933U



AH5934U



AH5935U

### Layer Block

Installation  
Horizontal



AH5411U



AH5412U



AH5413U



AH5414U



AH5415U

### Trimmed Rock

Installation  
Horizontal



AH5351U



AH5352U



AH5353U



AH5354U



AH5355U

### Land Wish

Installation  
Horizontal



AH5361U



AH5362U



AH5363U



AH5364U



AH5365U

### Carved Stone

Installation  
Horizontal

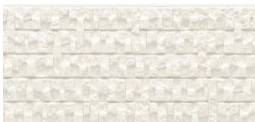

AH5381U



AH5382U



AH5383U



AH5384U



AH5385U

### Throne Ridge

Installation  
Horizontal



AH5391U



AH5392U



AH5393U



AH5394U



AH5395U



# FLAT DESIGN PANEL

16 mm thickness | FLAT DESIGN PANEL

16×455×3030(mm) | 10,200JPY/piece 7,400JPY/m<sup>2</sup>

Photocatalytic  
Self-  
cleaning

Weather  
resistance grade  
★★★

## Stone Tile

Straight joint  
Staggered joint

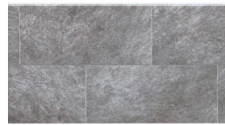
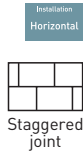
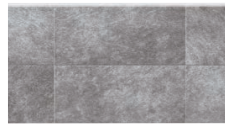

## Simple Dot



## Fierte

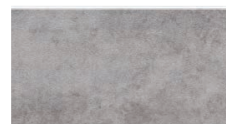
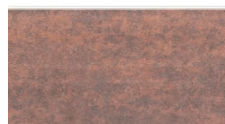
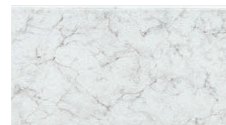
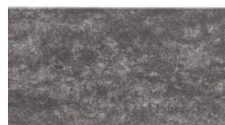



# Neorock Photocatalytic Ceramic Coating 18 Ceratopia

18 mm thickness | Neorock Photocatalytic Ceramic Coating 18 Ceratopia

18×455×3030(mm) | 10,200JPY/piece 7,400JPY/m<sup>2</sup>

Photocatalytic Self-cleaning  
Weather resistance grade ★★

## Wood Lap

Installation  
Horizontal



NH5421A



NH5422A



NH5423A



NH5424A

## Facade Stone 18

Installation  
Horizontal



NH5731A



NH5732A



NH5733A

## Polished Stone 18

Installation  
Horizontal



NH5801A



NH5802A



NH5803A

## Gemma 18

Installation  
Horizontal



NH5811A



NH5813A

## New Inplace 18

Installation  
Horizontal



NH5641A



NH5642A

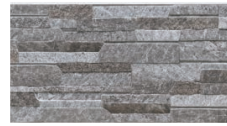

NH5643A

## Contrast Border 18

Installation  
Horizontal



NH5741A



NH5743A



NH5745A



NH5746A

## Variosta

Installation  
Horizontal



NH5901A



NH5902A



NH5903A

## Remare 18

Installation  
Horizontal



NH5821A



NH5822A



NH5823A

18 mm thickness | Neorock Photocatalytic Ceramic Coating 18 Ceratopia

18x455x3030(mm) | 10,200JPY/piece 7,400JPY/m<sup>2</sup>

Photocatalytic Self-cleaning  
Weather resistance grade ★★

Grat

Installation  
Horizontal

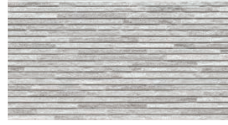

NH5831A



NH5834A



NH5835A



NH5837A

Millefeuille Tile 18

Installation  
Horizontal



NH5751A



NH5752A



NH5753A



NH5754A

Shatelet Brick 18

Installation  
Horizontal

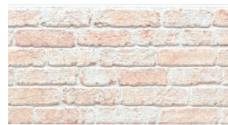

NH5671A



NH5672A



NH5673A



NH5674A

Odd Cedar

Installation  
Horizontal  
Vertical



NH5911A



NH5912A



NH5913A

Barn Wood 18

Installation  
Horizontal  
Vertical



NH5771A



NH5772A



NH5773A



NH5774A



NH5775A



NH5776A

Brulee Wood 18

Installation  
Horizontal  
Vertical



NH5685A



NH5686A



NH5687A



NH5689A

Board Formed Concrete 18

Installation  
Horizontal  
Vertical



NH5761A



NH5762A



NH5763A



NH5764A

Suranang

Installation  
Horizontal  
Vertical



NH5941A



NH5942A



NH5943A



NH5944A



NH5945A



NH5946A



NH5947A

# Neorock Photocatalytic Ceramic Coating 18

18 mm thickness | Neorock Photocatalytic Ceramic Coating 18

18×455×3030(mm) | 9,500JPY/piece 6,890JPY/m<sup>2</sup>

Photocatalytic Self-cleaning  
Weather resistance grade ★★

## Oval Stone

Installation  
Horizontal



NH5701U



NH5702U



NH5703U



NH5704U

## Float Bar

Installation  
Horizontal



NH5861U



NH5862U



NH5863U



NH5864U

## Garland Tile

Installation  
Horizontal



NH5281U



NH5282U



NH5284U

## Farbe Stone

Installation  
Horizontal



NH5711U

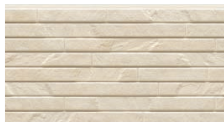

NH5712U



NH5713U



NH5714U



NH5715U

## New Layer Relief 18

Installation  
Horizontal



NH5542K

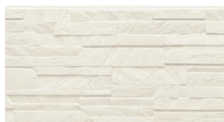

NH5546K



NH5547K

## Maree Stone 18

Installation  
Horizontal



NH5461K

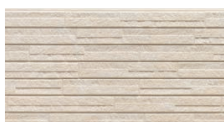

NH5462K



NH5464K



NH5465K



NH5467K

18 mm thickness | Neorock Photocatalytic Ceramic Coating 18

18x455x3030(mm) | 9,500JPY/piece 6,890JPY/m<sup>2</sup>

Photocatalytic Self-cleaning  
Weather resistance grade ★★

New Ridge Wave 18

Installation Horizontal



NH5551K



NH5552K



NH5554K



NH5555K



NH5556K

Harmoride

Installation Horizontal



G NH5201A  
H NH5201U  
F NH5201K



G NH5202A  
H NH5202U  
F NH5202K



G NH5203A  
H NH5203U  
F NH5203K



G NH5204A  
H NH5204U  
F NH5204K



G NH5205A  
H NH5205U  
F NH5205K



G NH5206A  
H NH5206U  
F NH5206K

Chic Border 18

Installation Horizontal



G NH5561A  
J NH5561K



G NH5562A  
J NH5562K



G NH5564A  
J NH5564K

Dilectone 18

Installation Horizontal



NH5451K



NH5455K



NH5456K



NH5457K

Natural Brick 18

Installation Horizontal

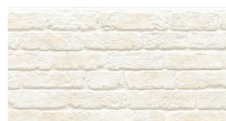

NH5571U



NH5572U



NH5573U



NH5574U



NH5575U



NH5576U

Drawer Tile 18

Installation Horizontal



NH5581U



NH5582U



NH5583U



NH5584U

# Neorock Photocatalytic Ceramic Coating 18

18 mm thickness | Neorock Photocatalytic Ceramic Coating 18

18×455×3030(mm) | 9,500JPY/piece 6,890JPY/m<sup>2</sup>

Photocatalytic Self-cleaning  
Weather resistance grade ★★

## Raster Tile

Installation  
Horizontal



NH5851U



NH5852U

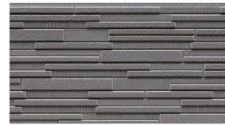

NH5853U



NH5854U

## Composition

Installation  
Horizontal



NH5271U



NH5273U



NH5274U

## Urban Cedar 18

Installation  
Horizontal and Vertical



NH5532U

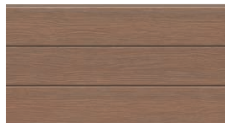

NH5533U



NH5534U

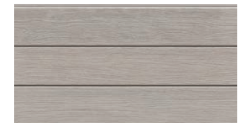

NH5535U

## Edel Wood

Installation  
Horizontal and Vertical

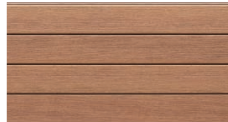

NH5872U

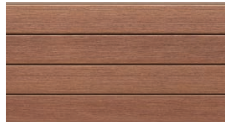

NH5873U

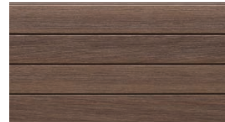

NH5874U

## Sephiro Wood 18

Installation  
Horizontal and Vertical



NH5475U



NH5476U



NH5477U



NH5478U



NH5479U



NH54710U



NH54711U



NH54712U

## Mesh Line

Installation  
Horizontal and Vertical



NH5891U



NH5892U



NH5893U



NH5894U

18 mm thickness | Neorock Photocatalytic Ceramic Coating 18

18×455×3030(mm) | 9,200JPY/piece 6,670JPY/m<sup>2</sup>

Photocatalytic  
Self-  
cleaning

Weather  
resistance grade  
★★★

Eclath

Installation  
Horizontal



NH5401A



NH5402A



NH5404A

Resti

Installation  
Horizontal



NH5231U



NH5232U



NH5234U



NH5235U

Round Wave

Installation  
Horizontal  
and  
Vertical



NH5125K



NH5126K



NH5127K



NH5128K

Imperial

Installation  
Horizontal



**E** NH5721U  
**F** NH5721K



**E** NH5722U  
**F** NH5722K



**E** NH5723U  
**F** NH5723K



**E** NH5724U  
**F** NH5724K



**E** NH5725U  
**F** NH5725K



**E** NH5726U  
**F** NH5726K



**E** NH5727U  
**F** NH5727K

Sho Sugi Ban

Installation  
Horizontal  
and  
Vertical



NH5481U



NH5491U

# Neorock Photocatalytic Ceramic Coating 18

18 mm thickness | Neorock Photocatalytic Ceramic Coating 18

18×455×3030(mm) | 9,200JPY/piece 6,670JPY/m<sup>2</sup>

Photocatalytic  
Self-  
cleaning

Weather  
resistance grade  
★★★

## Carnac 18

Installation  
Horizontal



G NH5501A  
H NH5501U  
F NH5501K



G NH5502A  
H NH5502U  
F NH5502K

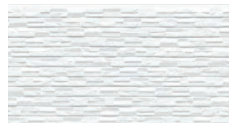

G NH5503A  
H NH5503U  
F NH5503K



G NH5504A  
H NH5504U  
F NH5504K



G NH5505A  
H NH5505U  
F NH5505K

## Simple Stripe 18

Installation  
Horizontal  
and  
Vertical



E NH5881U  
F NH5881K



E NH5882U  
F NH5882K



E NH5883U  
F NH5883K



E NH5884U  
F NH5884K



E NH5885U  
F NH5885K



E NH5886U  
F NH5886K



E NH5887U  
F NH5887K



E NH5888U  
F NH5888K

## Modern Slit 18

Installation  
Horizontal  
and  
Vertical

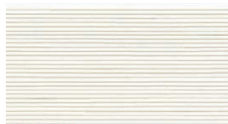

NH5441K



NH5445K



NH5447K



NH5449K



NH54410K

18 mm thickness | Neorock Photocatalytic Ceramic Coating 18

18x455x3030(mm) | 9,200JPY/piece 6,670JPY/m<sup>2</sup>

Photocatalytic  
Self-  
cleaning

Weather  
resistance grade  
☆☆☆

Cantabile

Installation  
Horizontal  
and  
Vertical



NH5921A



NH5922A



NH5923A



NH5924A

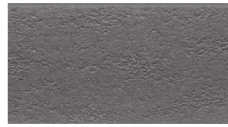

NH5925A

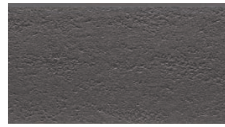

NH5926A

Knitty 18

Installation  
Horizontal  
and  
Vertical



NH5621K



NH5622K



NH5624K

Strahl 18

Installation  
Horizontal



G NH5791A  
H NH5791U  
F NH5791K



G NH5792A  
H NH5792U  
F NH5792K



G NH5793A  
H NH5793U  
F NH5793K



G NH5794A  
H NH5794U  
F NH5794K



G NH5796A  
H NH5796U  
F NH5796K



G NH5797A  
H NH5797U  
F NH5797K



G NH5798A  
H NH5798U  
F NH5798K



G NH5799A  
H NH5799U  
F NH5799K



G NH57910A  
H NH57910U  
F NH57910K

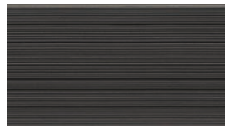

G NH57911A  
H NH57911U  
F NH57911K

Fiotto 18

Installation  
Horizontal  
and  
Vertical



E NH5631U  
F NH5631K



E NH5632U  
F NH5632K



E NH5633U  
F NH5633K



E NH5636U  
F NH5636K



E NH56313U  
F NH56313K



E NH56314U  
F NH56314K

## Excellage Photocatalytic Ceramic Coating 15

15 mm thickness | Excellage Photocatalytic Ceramic Coating 15

15×455×3030(mm) | 8,900JPY/piece 6,460JPY/m<sup>2</sup>

Photocatalytic  
Self-  
cleaning

Weather  
resistance grade  
★★★

### Bastia

Installation  
Horizontal

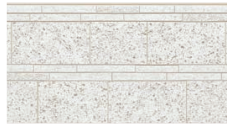

EH7721H



EH7722H



EH7723H



EH7724H



EH7725H

### Solennael

Installation  
Horizontal  
and  
Vertical



EH7081K



EH7082K



EH7083K



EH7084K

### Silbus Tile 15

Installation  
Horizontal



EH37012K



EH37013K



EH37014K



EH37015K



EH37016K

### Fine Cresta 15

Installation  
Horizontal



EH3491K



EH3493K



EH3497K



EH3498K

### Roche Stripe

Installation  
Horizontal



EH4832K



EH4833K



EH4834K

### Traditional Border 15

Installation  
Horizontal  
and  
Vertical

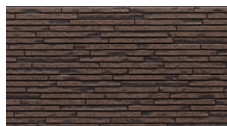

EH3674K



EH3678K



EH3679K



EH36710K



EH36711K

### Baker Brick

Installation  
Horizontal



EH4276K



EH4278K



EH4279K

15 mm thickness | Excellage Photocatalytic Ceramic Coating 15

15x455x3030(mm) | 8,900JPY/piece 6,460JPY/m<sup>2</sup>

Photocatalytic Self-cleaning  
Weather resistance grade ★★

Stable Tile

Installation  
Horizontal



EH4412K



EH4417K

Cube Sucre 15

Installation  
Horizontal



EH3946K



EH3947K

Scratch Cross

Installation  
Horizontal



EH4041K

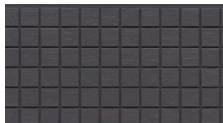

EH4044K

Clair Wood 15

Installation  
Horizontal and Vertical



EH42310K



EH42311K



EH42312K

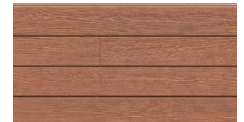

EH42313K



EH42314K



EH42315K



EH42316K

Cimant Flat

Installation  
Horizontal and Vertical

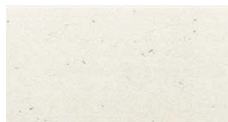

EH7301H



EH7302H



A EH7303H

B EH7303K



A EH7304H

B EH7304K

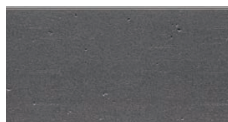

EH7305H



EH7306K



EH7307K

Plaster Flat 15

Installation  
Horizontal and Vertical

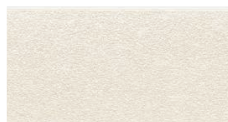

A EH7531H

B EH7531K



A EH7532H

B EH7532K



A EH7533H

B EH7533K

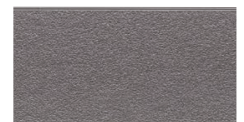

A EH7534H

B EH7534K



A EH7535H

B EH7535K

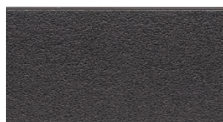

A EH7536H

B EH7536K

# Excellage Photocatalytic Ceramic Coating 15

15 mm thickness | Excellage Photocatalytic Ceramic Coating 15

15×455×3030(mm) | 8,600JPY/piece 6,240JPY/m<sup>2</sup>

Photocatalytic Self-cleaning  
Weather resistance grade ★★★

## Smash Line 15

Installation Horizontal



## Placido 15

Installation Horizontal





# Neorock Hydrophilic 16

16 mm thickness | Neorock Hydrophilic 16

16×455×3030(mm) | 7,800JPY/piece 5,660JPY/m<sup>2</sup>

Hydrophilic Self-cleaning  
Weather resistance grade ★

## New Ridge Wave 16

Installation  
Horizontal



G NW7591A  
J NW7591K



G NW7592A  
J NW7592K



G NW7593A  
J NW7593K

## New Slim Stone

Installation  
Horizontal and Vertical



G NW4691A  
J NW4691K



G NW4694A  
J NW4694K



G NW4696A  
J NW4696K



G NW4697A  
J NW4697K



G NW4698A  
J NW4698K



G NW4699A  
J NW4699K



G NW46910A  
J NW46910K

## Natural Brick 16

Installation  
Horizontal



NW3835K



NW3836K

## Drawer Tile 16

Installation  
Horizontal



NW4525A



NW4526A



NW4527A

## Sephiro Wood 16

Installation  
Horizontal and Vertical



NW4054K



NW4056K



NW4057K



NW4058K



NW4059K



NW40510K

16 mm thickness | Neorock Hydrophilic 16

16x455x3030(mm) | 7,800JPY/piece 5,660JPY/m<sup>2</sup>

Hydrophilic  
Self-  
cleaning

Weather  
resistance grade  
★

Carnac 16

Installation  
Horizontal

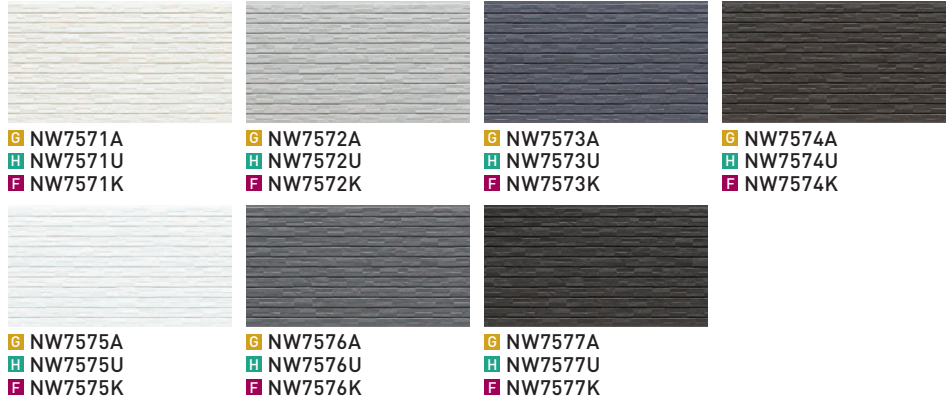

Ahmar Wood

Installation  
Horizontal  
and  
Vertical



Simple Stripe 16

Installation  
Horizontal  
and  
Vertical

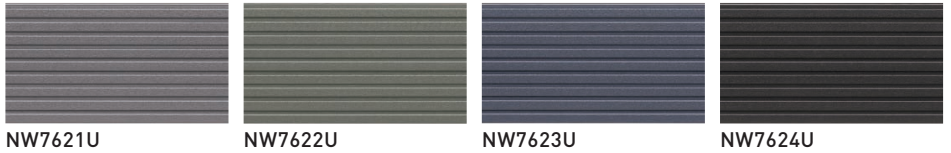

Modern Slit 16

Installation  
Horizontal  
and  
Vertical

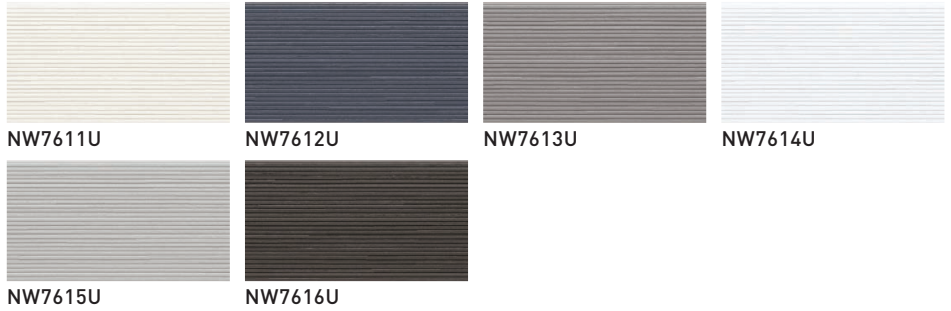

Mortan

Installation  
Horizontal  
and  
Vertical

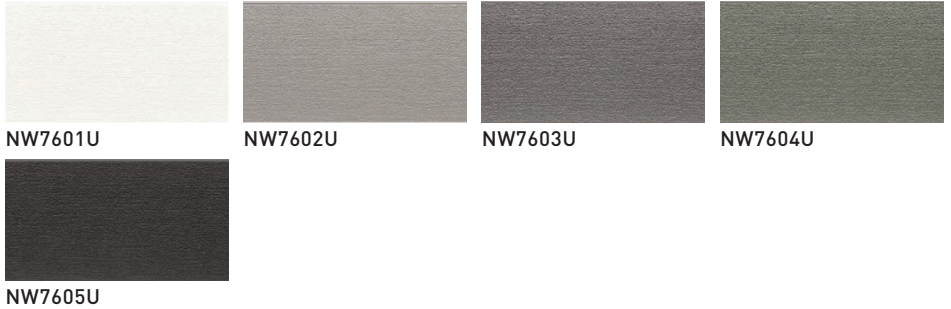

# Neorock Hydrophilic 16

16 mm thickness | Neorock Hydrophilic 16

16×455×3030(mm) | 7,800JPY/piece 5,660JPY/m<sup>2</sup>

Hydrophilic Self-cleaning  
Weather resistance grade ★

## Knitty 16

Installation  
Horizontal  
and  
Vertical



NW4951U



NW4952U



NW4954U

## Fiotto 16

Installation  
Horizontal  
and  
Vertical



G NW3751A  
J NW3751K



G NW3752A  
J NW3752K



G NW3753A  
J NW3753K



G NW3757A  
J NW3757K

## Strahl 16

Installation  
Horizontal



NW4341A



NW4343A



NW4344A



NW4346A



NW4347A



NW4349A



NW43410A



NW43411A



# Excellage Hydrophilic 15

15 mm thickness | Excellage Hydrophilic 15

15x455x3030(mm) | 6,500JPY/piece 4,710JPY/m<sup>2</sup>

Hydrophilic Self-cleaning  
Weather resistance grade ★★

## Bastia

Installation  
Horizontal



EW7721H



EW7722H



EW7723H



EW7724H



EW7725H

## Silbus Tile 15

Installation  
Horizontal

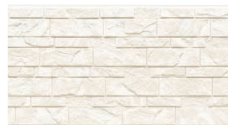

EW37010K



EW37011K



EW37012K



EW37013K

## Pietra Relief

Installation  
Horizontal

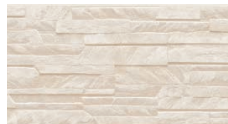

EW7541H



EW7542H



EW7543H



EW7544H

## Lapis Wave

Installation  
Horizontal



EW7333K



EW7334K



EW7335K



EW7336K

## Elongated Stone

Installation  
Horizontal and Vertical



EW7344K



EW7345K



EW7346K



EW7347K



EW7348K



EW7349K



EW73410K

## Traditional Border 15

Installation  
Horizontal and Vertical



EW3679K



EW36710K



EW36711K

## Verde Brick

Installation  
Horizontal



EW7352H



EW7355H

15 mm thickness | Excellage Hydrophilic 15

15×455×3030(mm) | 6,500JPY/piece 4,710JPY/m<sup>2</sup>

Hydrophilic  
Self-  
cleaning

Weather  
resistance grade  
★★

Baker Brick

Installation  
Horizontal



EW4274K



EW4275K



EW4276K

Stable Tile

Installation  
Horizontal



EW4416K



EW4417K



EW4418K

Scratch Cross

Installation  
Horizontal



EW4044K



EW4046K



EW4047K

Bare Concrete 15

Installation  
Horizontal  
and  
Vertical



EW3572H

Luminous Wood

Installation  
Horizontal  
and  
Vertical



EW7361H



EW7362H



EW7363H



EW7364H



EW7365H

Clair Wood 15

Installation  
Horizontal  
and  
Vertical



EW4239K

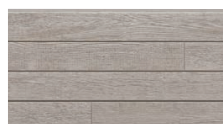

EW42310K



EW42311K



EW42312K



EW42313K

# Excellage Hydrophilic 15

15 mm thickness | Excellage Hydrophilic 15

15×455×3030(mm) | 6,500JPY/piece 4,710JPY/m<sup>2</sup>

Hydrophilic Self-cleaning  
Weather resistance grade ★★

## Cimant Flat

Insulation Horizontal and Vertical



EW7301H



EW7302H

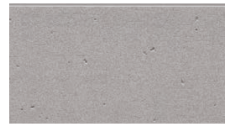

A EW7303H  
B EW7303K



A EW7304H  
B EW7304K



EW7305H

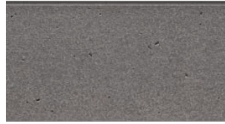

EW7306K



EW7307K

## Plaster Flat 15

Insulation Horizontal and Vertical



A EW7531H  
B EW7531K



A EW7532H  
B EW7532K



A EW7533H  
B EW7533K

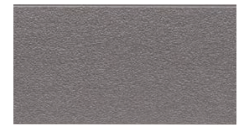

A EW7534H  
B EW7534K



A EW7535H  
B EW7535K



A EW7536H  
B EW7536K

## Orden

Insulation Horizontal and Vertical



EW7072H



EW7075H

## Pebble

Insulation Horizontal



EW7371K



EW7372K



EW7373K



EW7374K



EW7375K

15 mm thickness | Excellage Hydrophilic 15

15x455x3030(mm) | 6,500JPY/piece 4,710JPY/m<sup>2</sup>

Hydrophilic  
Self-  
cleaning

Weather  
resistance grade  
★★

Elenore

Installation  
Horizontal



EW7061K



EW7063K

Alivio

Installation  
Horizontal



EW7101K



EW7103K

Smash Line 15

Installation  
Horizontal



A EW4221H  
B EW4221K



A EW4222H  
B EW4222K



A EW4223H  
B EW4223K



A EW4224H  
B EW4224K



A EW4225H  
B EW4225K



A EW4226H  
B EW4226K



A EW4228H  
B EW4228K

Placido 15

Installation  
Horizontal



EW3871H

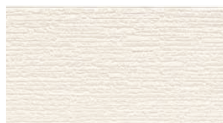

EW38710H

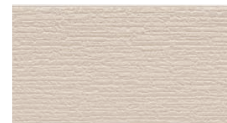

EW38711H

Luge 15

Installation  
Horizontal



EW7381H



EW7382H



EW7383H



EW7384H



EW7385H



EW7386H



Legerair  
Peerless Stone  
AH5931U

**Legerair**

- Peerless Stone
- Layer Block
- Trimmed Rock
- Land Wish
- Carved Stone
- Throne Ridge

■ Joint Alignment & Connection Sections

**Joint Alignment with Caulking**

- To enhance the natural appearance of the design, the joint width intentionally varies.  
In addition, the joints on both sides of the caulking may be misaligned by approximately 3mm.
- The joint width varies to create a natural design expression.
- The joints on either side of the caulking may be offset by around 3mm.

**Connection Sections**

A joint is placed every approx. 455mm in the vertical direction.  
Depending on lighting conditions, sunlight, or viewing angle, subtle shadows or slight gaps may appear along the joint lines.

■ Performance List

item	unit	Legerair	note
		21mm thickness	
specific gravity	—	1.0*	Drying at 105°C for 24 hours
Water content	%	20 or under	JISA5422
Water absorption rate	%	50 or under	Water absorption 24h→105°C 24h
Bending Failure Load	N	1000 or over	JISA5422
Impact resistance	—	Passed	JISA5422

\*These are our measured values.

# Peerless Stone

Coating performance Photocatalytic Self-cleaning	Weather resistance Weather resistance grade ★★★	Installation Installation Horizontal
---	--	---



AH5931U



AH5932U



AH5933U



AH5934U



AH5935U

## Specifications

Size	21×455(exposed width)×3030mm
Price	<b>14,900 JPY</b> /piece 10,810 JPY/m <sup>2</sup>
Number of panel per package	2 pieces
Coverage	1.38m <sup>2</sup> /piece
Weight	Approx. 26kg/piece

## Outside corner

Outside corner l=455

21×outside:96(inside:75)×455(exposed width)  
21×outside:101(inside:80)×455(exposed width)

## Accessories list

Genuine accessories are required to install siding panels

Panel	Accessories		Caulking (Holder set: B80E)		Repair Paint
	Outside corner l=455(inside:75)	Outside corner l=455(inside:80)			
AH5931U	AHD5931U	AHC5931U	B8440Z2491B	B84302491A	B96L3104AU
AH5932U	AHD5932U	AHC5932U	B8440Z746	B8430746	B96L1439BU
AH5933U	AHD5933U	AHC5933U	B8440Z713B	B8430713	B96L2416EU
AH5934U	AHD5934U	AHC5934U	B8440Z2525	B84302525	B96L2525DU
AH5935U	AHD5935U	AHC5935U	B8440Z3051A	B84303051	B96L3106AU
Price	<b>5,800 JPY</b> /piece	<b>6,100 JPY</b> /piece	<b>10,100 JPY</b> /piece	<b>6,600 JPY</b> /piece	<b>6,600 JPY</b> /box
Number of panel per package	10 pieces/box (Ordering Unit 1piece)	10 pieces/box (Ordering Unit 1piece)	10 pieces/box <sup>1)</sup> (Ordering Unit 1piece)	10 pieces/box <sup>1)</sup> (Ordering Unit 1piece)	1 set/box
			Caulking(600ml)10pieces, Primer,brush,nozzle2pieces	Caulking(600ml)10pieces, Primer,brush,nozzle2pieces	Inorganic ever-drying type Paint Base(10g)1piece,Hardener(7g)1pieces, Primer(7.5g)1piece,brush2pieces
			*Holder set are sold separately	*Holder set are sold separately	

<sup>1)</sup> The dedicated primer (part number B85AA or B85BB) will be shipped at the same time.

# Layer Block

Coating performance Photocatalytic Self-cleaning	Weather resistance Weather resistance grade ★★★	Installation Installation Horizontal
---	--	--



AH5411U



AH5412U



AH5413U



AH5414U



AH5415U

## Specifications

Size	21×455(exposed width)×3030mm
Price	<b>14,900JPY/piece</b> 10,810JPY/m <sup>2</sup>
Number of panel per package	2pieces
Coverage	1.38m <sup>2</sup> /piece
Weight	Approx. 26kg/piece

## Outside corner

Outside corner l=455

21×outside:96(inside:75)×455(exposed width)  
21×outside:101(inside:80)×455(exposed width)

## Accessories list

Genuine accessories are required to install siding panels

Panel	Accessories		Caulking (Holder set: B80E)		Repair Paint
	Outside corner l=455(inside:75)	Outside corner l=455(inside:80)			
AH5411U	AHD5411U	AHC5411U	B8440Z2491B	B84302491C	B96L3104AU
AH5412U	AHD5412U	AHC5412U	B8440Z746	B8430746	B96L1439BU
AH5413U	AHD5413U	AHC5413U	B8440Z713B	B8430713B	B96L3205AU
AH5414U	AHD5414U	AHC5414U	B8440Z3243	B84303243	B96L3243AU
AH5415U	AHD5415U	AHC5415U	B8440Z3051	B84303051	B96L3106AU
Price	<b>5,800JPY/piece</b>	<b>6,100JPY/piece</b>	<b>10,100JPY/piece</b>	<b>6,600JPY/piece</b>	<b>6,600JPY/box</b>
Number of panel per package	10 pieces/box (Ordering Unit 1piece)	10 pieces/box (Ordering Unit 1piece)	10 pieces/box <sup>1)</sup> (Ordering Unit 1piece)	10 pieces/box <sup>1)</sup> (Ordering Unit 1piece)	1 set/box
			Caulking(600ml)10pieces, Primer,brush,nozzle2pieces	Caulking(600ml)10pieces, Primer,brush,nozzle2pieces	Inorganic ever-drying type Paint Base(10g)1piece,Hardener(7g)1pieces, Primer(7.5g)1piece,brush2pieces
			*Holder set are sold separately	*Holder set are sold separately	

<sup>1)</sup> The dedicated primer (part number B85AA or B85BB) will be shipped at the same time.

# Trimmed Rock

Coating performance Photocatalytic Self-cleaning	Weather resistance Weather resistance grade ★★★	Installation Installation Horizontal
---	--	--



AH5351U



AH5352U



AH5353U

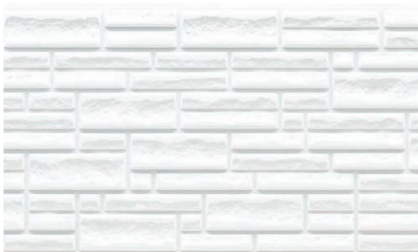

AH5354U



AH5355U

## Specifications

Size	21×455(exposed width)×3030mm
Price	<b>14,900JPY/piece</b> 10,810JPY/m <sup>2</sup>
Number of panel per package	2pieces
Coverage	1.38m <sup>2</sup> /piece
Weight	Approx. 25kg/piece

## Outside corner

Outside corner l=455

21×outside:96(inside:75)×455(exposed width)  
21×outside:101(inside:80)×455(exposed width)

## Accessories list

Genuine accessories are required to install siding panels

Panel	Accessories		Caulking (Holder set: B80E)		Repair Paint
	Outside corner l=455(inside:75)	Outside corner l=455(inside:80)			
AH5351U	AHD5351U	AHC5351U	B8440Z2491B	B84302491C	B96L3104AU
AH5352U	AHD5352U	AHC5352U	B8440Z746	B8430746	B96L1439BU
AH5353U	AHD5353U	AHC5353U	B8440Z713B	B8430713B	B96L3205AU
AH5354U	AHD5354U	AHC5354U	B8440Z3051	B84303051	B96L3106AU
AH5355U	AHD5355U	AHC5355U	B8440Z1615	B84301615	B96L3209AU
Price	<b>5,800JPY/piece</b>	<b>6,100JPY/piece</b>	<b>10,100JPY/piece</b>	<b>6,600JPY/piece</b>	<b>6,600JPY/box</b>
Number of panel per package	10 pieces/box (Ordering Unit 1piece)	10 pieces/box (Ordering Unit 1piece)	10 pieces/box <sup>1)</sup> (Ordering Unit 1piece)	10 pieces/box <sup>1)</sup> (Ordering Unit 1piece)	1 set/box
			Caulking(600ml)10pieces, Primer,brush,nozzle2pieces	Caulking(600ml)10pieces, Primer,brush,nozzle2pieces	Inorganic ever-drying type Paint Base(10g)1piece,Hardener(7g)1pieces, Primer(7.5g)1piece,brush2pieces
			*Holder set are sold separately	*Holder set are sold separately	

<sup>1</sup> The dedicated primer (part number B85AA or B85BB) will be shipped at the same time.

# Land Wish

Coating performance Photocatalytic Self-cleaning	Weather resistance Weather resistance grade ★★★	Installation Installation Horizontal
---	--	--



AH5361U



AH5362U



AH5363U



AH5364U



AH5365U

## Specifications

Size	21×455(exposed width)×3030mm
Price	<b>14,900 JPY/piece</b> 10,810 JPY/m <sup>2</sup>
Number of panel per package	2 pieces
Coverage	1.38m <sup>2</sup> /piece
Weight	Approx. 25kg/piece

## Outside corner

Outside corner l=455

21×outside:96(inside:75)×455(exposed width)  
21×outside:101(inside:80)×455(exposed width)

## Accessories list

Genuine accessories are required to install siding panels

Panel	Accessories		Caulking (Holder set: B80E)		Repair Paint
	Outside corner l=455(inside:75)	Outside corner l=455(inside:80)			
AH5361U	AHD5361U	AHC5361U	B8440Z2491B	B84302491C	B96L3104AU
AH5362U	AHD5362U	AHC5362U	B8440Z746	B8430746	B96L1439BU
AH5363U	AHD5363U	AHC5363U	B8440Z713B	B8430713B	B96L3205AU
AH5364U	AHD5364U	AHC5364U	B8440Z408	B8430408	B96L3206AU
AH5365U	AHD5365U	AHC5365U	B8440Z3051	B84303051	B96L3106AU
Price	<b>5,800 JPY/piece</b>	<b>6,100 JPY/piece</b>	<b>10,100 JPY/piece</b>	<b>6,600 JPY/piece</b>	<b>6,600 JPY/box</b>
Number of panel per package	10 pieces/box (Ordering Unit 1piece)	10 pieces/box (Ordering Unit 1piece)	10 pieces/box <sup>1)</sup> (Ordering Unit 1piece)	10 pieces/box <sup>1)</sup> (Ordering Unit 1piece)	1 set/box
			Caulking(600ml)10pieces, Primer,brush,nozzle2pieces	Caulking(600ml)10pieces, Primer,brush,nozzle2pieces	Inorganic ever-drying type Paint Base(10g)1piece,Hardener(7g)1pieces, Primer(7.5g)1piece,brush2pieces
			*Holder set are sold separately	*Holder set are sold separately	

<sup>1)</sup> The dedicated primer (part number B85AA or B85BB) will be shipped at the same time.

# Carved Stone

Coating performance Photocatalytic Self-cleaning	Weather resistance Weather resistance grade ★★★	Installation Installation Horizontal
---	--	---



AH5381U



AH5382U



AH5383U



AH5384U



AH5385U

## Specifications

Size	21×455(exposed width)×3030mm
Price	<b>14,900 JPY/piece</b> 10,810 JPY/m <sup>2</sup>
Number of panel per package	2 pieces
Coverage	1.38m <sup>2</sup> /piece
Weight	Approx. 25kg/piece

## Outside corner

Outside corner l=455

21×outside:96(inside:75)×455(exposed width)  
21×outside:101(inside:80)×455(exposed width)

## Accessories list

Genuine accessories are required to install siding panels

Panel	Accessories		Caulking (Holder set: B80E)		Repair Paint
	Outside corner l=455(inside:75)	Outside corner l=455(inside:80)			
AH5381U	AHD5381U	AHC5381U	B8440Z2491B	B84302491C	B96L3104AU
AH5382U	AHD5382U	AHC5382U	B8440Z746	B8430746	B96L1439BU
AH5383U	AHD5383U	AHC5383U	B8440Z713B	B8430713B	B96L3205AU
AH5384U	AHD5384U	AHC5384U	B8440Z2417C	B8430969	B96L3208AU
AH5385U	AHD5385U	AHC5385U	B8440Z3051	B84303051	B96L3106AU
Price	<b>5,800 JPY/piece</b>	<b>6,100 JPY/piece</b>	<b>10,100 JPY/piece</b>	<b>6,600 JPY/piece</b>	<b>6,600 JPY/box</b>
Number of panel per package	10 pieces/box (Ordering Unit 1piece)	10 pieces/box (Ordering Unit 1piece)	10 pieces/box <sup>1)</sup> (Ordering Unit 1piece)	10 pieces/box <sup>1)</sup> (Ordering Unit 1piece)	1 set/box
			Caulking(600ml)10pieces, Primer,brush,nozzle2pieces	Caulking(600ml)10pieces, Primer,brush,nozzle2pieces	Inorganic ever-drying type Paint Base(10g)1piece,Hardener(7g)1pieces, Primer(7.5g)1piece,brush2pieces
			*Holder set are sold separately	*Holder set are sold separately	

<sup>1)</sup> The dedicated primer (part number B85AA or B85BB) will be shipped at the same time.

# Throne Ridge

Coating performance Photocatalytic Self-cleaning	Weather resistance Weather resistance grade ★★★	Installation Installation Horizontal
---	--	---



AH5391U



AH5392U



AH5393U



AH5394U



AH5395U

## Specifications

Size	21×455(exposed width)×3030mm
Price	<b>14,900 JPY/piece</b> 10,810 JPY/m <sup>2</sup>
Number of panel per package	2 pieces
Coverage	1.38m <sup>2</sup> /piece
Weight	Approx. 25kg/piece

## Outside corner

Outside corner l=455

21×outside:96(inside:75)×455(exposed width)  
21×outside:101(inside:80)×455(exposed width)

## Accessories list

Genuine accessories are required to install siding panels

Panel	Accessories		Caulking (Holder set: B80E)		Repair Paint
	Outside corner l=455(inside:75)	Outside corner l=455(inside:80)			
AH5391U	AHD5391U	AHC5391U	B8440Z2491B	B84302491C	B96L3104AU
AH5392U	AHD5392U	AHC5392U	B8440Z746	B8430746	B96L1439BU
AH5393U	AHD5393U	AHC5393U	B8440Z713B	B8430713B	B96L3205AU
AH5394U	AHD5394U	AHC5394U	B8440Z1615	B84301615	B96L3209AU
AH5395U	AHD5395U	AHC5395U	B8440Z3051	B84303051	B96L3106AU
Price	<b>5,800 JPY/piece</b>	<b>6,100 JPY/piece</b>	<b>10,100 JPY/piece</b>	<b>6,600 JPY/piece</b>	<b>6,600 JPY/box</b>
Number of panel per package	10 pieces/box (Ordering Unit 1piece)	10 pieces/box (Ordering Unit 1piece)	10 pieces/box <sup>1)</sup> (Ordering Unit 1piece) Caulking(600ml)10pieces, Primer,brush,nozzle2pieces	10 pieces/box <sup>1)</sup> (Ordering Unit 1piece) Caulking(600ml)10pieces, Primer,brush,nozzle2pieces	1 set/box Inorganic ever-drying type Paint Base(10g)1piece,Hardener(7g)1pieces, Primer(7.5g)1piece,brush2pieces
			*Holder set are sold separately	*Holder set are sold separately	

<sup>1)</sup> The dedicated primer (part number B85AA or B85BB) will be shipped at the same time.



FLAT DESIGN PANEL  
Stone Tile Staggered joint  
NH7701A

# FLAT DESIGN PANEL

- Stone Tile Straight joint
- Stone Tile Staggered joint
- Simple Dot
- Fierte

## ■ Joint Alignment & Connection Sections

### Joint Alignment with Caulking

- To enhance the natural appearance of the design, the joint width intentionally varies.  
In addition, the joints on both sides of the caulking may be misaligned by approximately 3mm.
- The joint width varies to create a natural design expression.
- The joints on either side of the caulking may be offset by around 3mm.

### Connection Sections

A joint is placed every approx. 455mm in the vertical direction.  
Depending on lighting conditions, sunlight, or viewing angle, subtle shadows or slight gaps may appear along the joint lines.

## ■ Performance List

item	unit	FLAT DESIGN PANEL	note
		16mm thickness	
specific gravity	—	1.0*	Drying at 105°C for 24 hours
Water content	%	20 or under	JISA5422
Water absorption rate	%	50 or under	Water absorption 24h→105°C 24h
Bending Failure Load	N	785 or over	JISA5422
Impact resistance	—	Passed	JISA5422

\*These are our measured values.

# FLAT DESIGN PANEL

## Stone Tile Straight joint Staggered joint

<b>Coating performance</b> Photocatalytic Self-cleaning	<b>Weather resistance</b> Weather resistance grade ★★★	<b>Installation</b> Installation Horizontal
---	--	---

Straight joint 



NH7511A

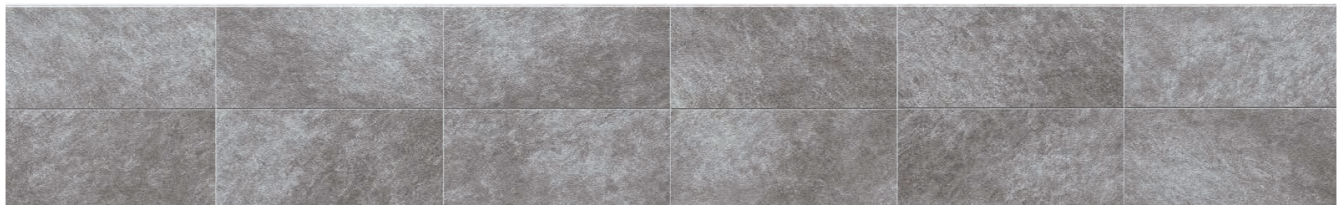

NH7512A



NH7513A

### Specifications

Size	16×455(exposed width)×3030mm
Price	<b>10,200 JPY</b> /piece 7,400 JPY/m <sup>2</sup>
Number of panel per package	2 pieces
Coverage	1.38m <sup>2</sup> /piece
Weight	Approx. 22kg/piece

### Outside corner



### Accessories list

Genuine accessories are required to install siding panels

Panel	Accessories	Outside corner l=455	Caulking (Holder set: B80E)	Repair Paint
NH7511A		NHD7511A	B84304093A	B98F4093AA
NH7512A		NHD7512A	B84304094A	B98F4094AA
NH7513A		NHD7513A	B84304095A	B98F4095AA
Price		<b>4,300 JPY</b> /piece	<b>6,600 JPY</b> /piece	<b>13,600 JPY</b> /box
Number of panel per package		10 pieces/box (Ordering Unit 1piece)	10 pieces/box <sup>*1</sup> (Ordering Unit 1piece) Caulking(600ml)10pieces, Primer,brush,nozzle2pieces <small>*Holder set are sold separately</small>	1 set/box Inorganic ever-drying type Paint Base(10g)3 kinds each,Hardener(7g)3pieces, Primer(7.5g)1piece, brush4pieces,felt stick3pieces

\*1 The dedicated primer (part number B85AA or B85BB) will be shipped at the same time.

Staggered joint 

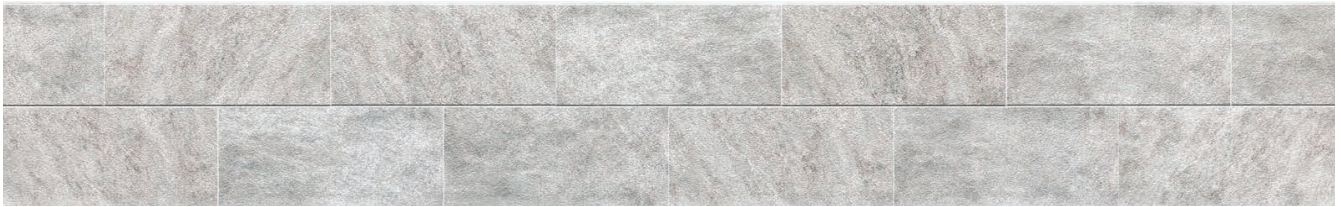

NH7701A



NH7702A



NH7703A

■ Specifications

Size	16×455(exposed width)×3030mm
Price	<b>10,200JPY</b> /piece 7,400JPY/m <sup>2</sup>
Number of panel per package	2pieces
Coverage	1.38m <sup>2</sup> /piece
Weight	Approx. 22kg/piece

■ Outside corner



■ Accessories list

Genuine accessories are required to install siding panels

Panel	Accessories	Outside corner l=455	Caulking (Holder set: B80E)	Repair Paint
NH7701A		NHD7511A	B84304093A	B98F4093AA
NH7702A		NHD7512A	B84304094A	B98F4094AA
NH7703A		NHD7513A	B84304095A	B98F4095AA
Price		<b>4,300JPY</b> /piece	<b>6,600JPY</b> /piece	<b>13,600JPY</b> /box
Number of panel per package		10 pieces/box (Ordering Unit 1piece)	10 pieces/box <sup>*1</sup> (Ordering Unit 1piece) Caulking(600ml)10pieces, Primer,brush,nozzle2pieces <small>*Holder set are sold separately</small>	1 set/box Inorganic ever-drying type Paint Base(10g)3 kinds each,Hardener(7g)3pieces, Primer(7.5g)1piece, brush4pieces,felt stick3pieces

\*1 The dedicated primer (part number B85AA or B85BB) will be shipped at the same time.

# FLAT DESIGN PANEL

## Simple Dot

<b>Coating performance</b>	<b>Weather resistance</b>	<b>Installation</b>
Photocatalytic Self-cleaning	Weather resistance grade ★★ ★	Installation Horizontal and Vertical



NH7291A



NH7292A

### Specifications

Size	16×455(exposed width)×3030mm
Price	<b>10,200 JPY/piece</b> 7,400 JPY/m <sup>2</sup>
Number of panel per package	2pieces
Coverage	1.38m <sup>2</sup> /piece
Weight	Approx. 22kg/piece

### Outside corner

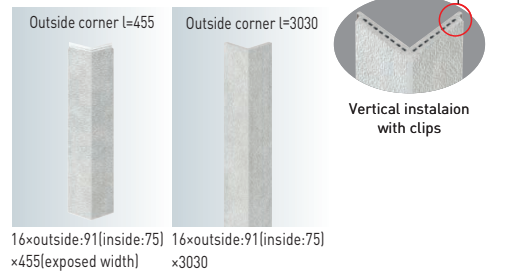

### Accessories list

Genuine accessories are required to install siding panels

Panel	Outside corner l=455	Outside corner l=3030	Through Wall Flashing l=3030	Caulking (Holder set: B80E)	Repair Paint
NH7291A	NHD7291A	NHP7291A	B2241557	B84302955	B97F4014AA
NH7292A	NHD7292A	NHP7292A	B2241557	B84304015	B97F4015AA
Price	4,300 JPY/piece	19,300 JPY/piece	3,200 JPY/piece	6,600 JPY/piece	13,100 JPY/box
Number of panel per package	10 pieces/box (Ordering Unit: 1piece)	1piece	5 pieces/box	10 pieces/box*1 (Ordering Unit: 1piece) Caulking(600ml)10pieces, Primer,brush,nozzle2pieces *Holder set are sold separately	1 set/box Inorganic ever-drying type,Paint Base(10g)2 kinds each, Hardener(7g)2pieces, Primer(7.5g)1piece,brush3pieces, felt stick2pieces

\*1 The dedicated primer (part number B85AA or B85BB) will be shipped at the same time.



# FLAT DESIGN PANEL

## Fierte

Coating performance  
Photocatalytic  
Self-cleaning

Weather resistance  
Weather resistance grade  
★★★

Installation  
Installation  
Horizontal and Vertical



NH4971A



NH4972A



NH4973A



NH4974A



NH4975A

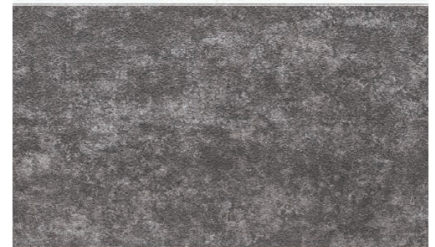

NH4976A



NH4977A



NH4978A

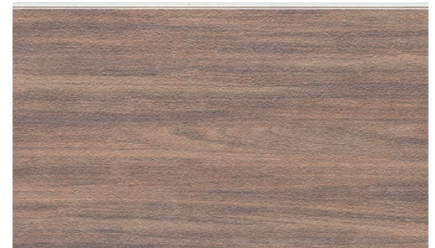

NH4979A



NH49710A



NH49711A

## Specifications

Size	16×455(exposed width)×3030mm
Price	<b>10,200JPY/piece</b> 7,400JPY/m <sup>2</sup>
Number of panel per package	2pieces
Coverage	1.38m <sup>2</sup> /piece
Weight	Approx. 22kg/piece

## Outside corner

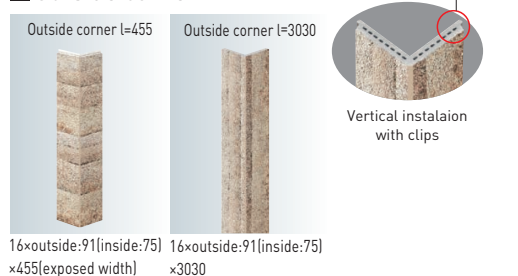

## Accessories list

Genuine accessories are required to install siding panels

Accessories	Outside corner l=455	Outside corner l=3030	Through Wall Flashing l=3030	Caulking (Holder set: B80E)	Repair Paint	
Panel						
NH4971A	NHD4971A	NHP4971A	B2241557	B84303887	B96F3887AA	—
NH4972A	NHD4972A	NHP4972A	B2241457	B84303888	B96F3888AA	—
NH4973A	NHD4973A	NHP4973A	B2241427	B84303889	B96F3889AA	—
NH4974A	NHD4974A	NHP4974A	B2241417	B84303890	—	B97F3890AA
NH4975A	NHD4975A	NHP4975A	B2241550	B84303891	B96F3891AA	—
NH4976A	NHD4976A	NHP4976A	B2241549	B84303892	—	B97F3892AA
NH4977A	NHD4977A	NHP4977A	B22413058	B84302947	B96F3936AA	—
NH4978A	NHD4978A	NHP4978A	B2241512	B84303937	B96F3937AA	—
NH4979A	NHD4979A	NHP4979A	B22413113	B8430442	—	B97F3938AA
NH49710A	NHD49710A	NHP49710A	B2241476	B84303939	—	B97F3939AA
NH49711A	NHD49711A	NHP49711A	B2241557	B84302949	—	B97F3988AA
Price	<b>4,300JPY/piece</b>	<b>19,300JPY/piece</b>	<b>3,200JPY/piece</b>	<b>6,600JPY/piece</b>	<b>6,600JPY/box</b>	<b>13,100JPY/box</b>
Number of panel per package	10 pieces/box (Ordering Unit 1piece)	1piece	5 pieces/box	10 pieces/box <sup>*1</sup> (Ordering Unit 1piece) Caulking(600ml)10pieces, Primer,brush,nozzle2pieces <small>*Holder set are sold separately</small>	1 set/box Inorganic ever-drying type, Paint Base(10g)1piece, Hardener(7g)1piece, Primer(7.5g)1piece,brush2pieces, felt stick1piece	1 set/box Inorganic ever-drying type Paint Base(10g)2 kinds each, Hardener(7g)2pieces, Primer(7.5g)1piece,brush3pieces, felt stick2pieces

\*1 The dedicated primer (part number B85AA or B85BB) will be shipped at the same time.



Neorock Photocatalytic Ceramic Coating 18 Ceratopia  
Suranang  
NH5943A

## Neorock Photocatalytic Ceramic Coating 18

### Neorock Photocatalytic Ceramic Coating 18 Ceratopia

Wood Lap  
 Facade Stone 18  
 Polished Stone 18  
 Gemma 18  
 New Inplace 18  
 Contrast Border 18  
 Variosta  
 Remare 18  
 Grat 18  
 Millefeuille Tile 18  
 Shatelet Brick 18  
 Odd Cedar  
 Barn Wood 18  
 Brulee Wood 18  
 Board Formed Concrete 18  
 Suranang

### Neorock Photocatalytic Ceramic Coating 18

Oval Stone  
 Float Bar  
 Garland Tile  
 Farbe Stone  
 New Layer Relief 18  
 Maree Stone 18  
 New Ridge Wave 18  
 Harmonized Lade  
 Chic Border 18  
 Dilectone 18  
 Natural Brick 18  
 Drawer Tile 18  
 Raster Tile  
 Composition  
 Urban Cedar 18  
 Edel Wood  
 Sephiro Wood 18  
 Mesh Line  
 Eclath  
 Resti  
 Round Wave  
 Imperial  
 Sho Sugi Ban  
 Carnac 18  
 Simple Stripe 18  
 Modern Slit 18  
 Cantabile  
 Knitty 18  
 Strahl 18  
 Fiotto 18

### ■ Joint Alignment & Connection Sections

#### Joint Alignment with Caulking

- To enhance the natural appearance of the design, the joint width intentionally varies.  
 In addition, the joints on both sides of the caulking may be misaligned by approximately 3mm.
- The joint width varies to create a natural design expression.
- The joints on either side of the caulking may be offset by around 3mm.

#### Connection Sections

A joint is placed every approx. 455mm in the vertical direction.  
 Depending on lighting conditions, sunlight, or viewing angle, subtle shadows or slight gaps may appear along the joint lines.

### ■ Performance List

item	unit	Neorock Photocatalytic Ceramic Coating 18	note
		18mm thickness	
specific gravity	—	1.0*	Drying at 105°C for 24 hours
Water content	%	20 or under	JISA5422
Water absorption rate	%	50 or under	Water absorption 24h→105°C 24h
Bending Failure Load	N	900 or over	JISA5422
Impact resistance	—	Passed	JISA5422

\*These are our measured values.

# Wood Lap

Coating performance	Weather resistance	Installation
Photocatalytic Self-cleaning	Weather resistance grade ★★	Installation Horizontal



NH5421A



NH5422A



NH5423A



NH5424A

## Specifications

Size	18×455(exposed width)×3030mm
Price	<b>10,200 JPY/piece</b> 7,400 JPY/m <sup>2</sup>
Number of panel per package	2pieces
Coverage	1.38m <sup>2</sup> /piece
Weight	Approx. 24kg/piece

## Outside corner

Outside corner l=455

18×outside:93(inside:75)  
×455(exposed width)

## Accessories list

Genuine accessories are required to install siding panels

Panel	Accessories	Outside corner l=455	Caulking (Holder set: B80E)	Repair Paint	
NH5421A		NHD5421A	B84303888	—	B98F3942AA
NH5422A		NHD5422A	B84301741A	B97F3943AA	—
NH5423A		NHD5423A	B84302414C	B97F3944AA	—
NH5424A		NHD5424A	B84302414	B97F3945AA	—
Price		<b>4,300 JPY/piece</b>	<b>6,600 JPY/piece</b>	<b>13,100 JPY/box</b>	<b>13,600 JPY/box</b>
Number of panel per package	10 pieces/box (Ordering Unit 1piece)	10 pieces/box <sup>*1</sup> (Ordering Unit 1piece)		1 set/box	1 set/box
		Caulking(600ml)10pieces, Primer,brush,nozzle2pieces <small>*Holder set are sold separately</small>		Inorganic ever-drying type Paint Base(10g)2 kinds each,Hardener(7g)2pieces, Primer(7.5g)1piece, brush3pieces,felt stick2pieces	Inorganic ever-drying type Paint Base(10g)5 kinds each,Hardener(7g)3pieces, Primer(7.5g)1piece, brush4pieces,felt stick3pieces

\*1 The dedicated primer (part number B85AA or B85BB) will be shipped at the same time.

# Facade Stone 18

Coating performance	Weather resistance	Installation
Photocatalytic Self-cleaning	Weather resistance grade ★★★	Installation Horizontal



NH5731A



NH5732A



NH5733A

## Specifications

Size	18×455(exposed width)×3030mm
Price	<b>10,200 JPY</b> /piece 7,400 JPY/m <sup>2</sup>
Number of panel per package	2pieces
Coverage	1.38m <sup>2</sup> /piece
Weight	Approx. 23kg/piece

## Outside corner



## Accessories list

Genuine accessories are required to install siding panels

Panel	Accessories	Outside corner l=455	Caulking (Holder set: B80E)	Repair Paint
NH5731A		NHD5731A	B84302872	B98F3816AA
NH5732A		NHD5732A	B84302873	B98F3817AA
NH5733A		NHD5733A	B84303818	B98F3818AA
Price		<b>4,300 JPY</b> /piece	<b>6,600 JPY</b> /piece	<b>13,600 JPY</b> /box
Number of panel per package		10 pieces/box (Ordering Unit 1piece)	10 pieces/box <sup>*1</sup> (Ordering Unit 1piece) Caulking(600ml)10pieces, Primer,brush,nozzle2pieces <small>*Holder set are sold separately</small>	1 set/box Inorganic ever-drying type Paint Base(10g)3 kinds each,Hardener(7g)3pieces, Primer(7.5g)1piece, brush4pieces,felt stick3pieces

<sup>\*1</sup> The dedicated primer (part number B85AA or B85BB) will be shipped at the same time.

# Polished Stone 18

<b>Coating performance</b>	<b>Weather resistance</b>	<b>Installation</b>
Photocatalytic Self-cleaning	Weather resistance grade ★★	Installation Horizontal



NH5801A



NH5802A

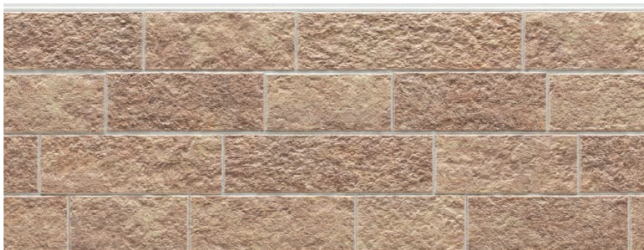

NH5803A

## Specifications

Size	18×455(exposed width)×3030mm
Price	<b>10,200 JPY</b> /piece 7,400 JPY/m <sup>2</sup>
Number of panel per package	2 pieces
Coverage	1.38m <sup>2</sup> /piece
Weight	Approx. 22kg/piece

## Outside corner



## Accessories list

Genuine accessories are required to install siding panels

Panel	Accessories	Outside corner l=455	Caulking (Holder set: B80E)	Repair Paint	
NH5801A		NHD5801A	B8430975	B97F2934AA	—
NH5802A		NHD5802A	B84302491A	—	B98F2935AA
NH5803A		NHD5803A	B84302978	—	B98F2936AA
Price		<b>4,300 JPY</b> /piece	<b>6,600 JPY</b> /piece	<b>13,100 JPY</b> /box	<b>13,600 JPY</b> /box
Number of panel per package	10 pieces/box (Ordering Unit 1 piece)	10 pieces/box <sup>*1</sup> (Ordering Unit 1 piece)	Caulking(600ml)10pieces, Primer,brush,nozzle2pieces	1 set/box	
				Inorganic ever-drying type Paint Base(10g)2 kinds each,Hardener(7g)2pieces, Primer(7.5g)1piece, brush3pieces,felt stick2pieces	
		*Holder set are sold separately		Inorganic ever-drying type Paint Base(10g)5 kinds each,Hardener(7g)3pieces, Primer(7.5g)1piece, brush4pieces,felt stick3pieces	

\*1 The dedicated primer (part number B85AA or B85BB) will be shipped at the same time.

# Gemma 18

<b>Coating performance</b>	<b>Weather resistance</b>	<b>Installation</b>
Photocatalytic Self-cleaning	Weather resistance grade ★★ ★	Installation Horizontal



NH5811A



NH5813A

## Specifications

Size	18×455(exposed width)×3030mm
Price	<b>10,200 JPY</b> /piece 7,400 JPY/m <sup>2</sup>
Number of panel per package	2 pieces
Coverage	1.38m <sup>2</sup> /piece
Weight	Approx. 23kg/piece

## Outside corner



## Accessories list

Genuine accessories are required to install siding panels

Panel	Accessories	Outside corner l=455	Caulking (Holder set: B80E)	Repair Paint
NH5811A		NHD5811A	B8430978	B97F2985AA
NH5813A		NHD5813A	B84301847	B97F2987AA
Price		4,300 JPY/piece	6,600 JPY/piece	13,100 JPY/box
Number of panel per package		10 pieces/box (Ordering Unit 1 piece)	10 pieces/box <sup>*1</sup> (Ordering Unit 1 piece) Caulking(600ml)10 pieces, Primer,brush,nozzle2 pieces	1 set/box Inorganic ever-drying type Paint Base(10g)2 kinds each,Hardener(7g)2 pieces, Primer(7.5g)1 piece, brush3 pieces,felt stick2 pieces

\*1 Holder set are sold separately

\*1 The dedicated primer (part number B85AA or B85BB) will be shipped at the same time.

# New Inplace 18

Coating performance	Weather resistance	Installation
Photocatalytic Self-cleaning	Weather resistance grade ★★★	Installation Horizontal



NH5641A



NH5642A



NH5643A

## Specifications

Size	18×455(exposed width)×3030mm
Price	<b>10,200 JPY/piece</b> 7,400 JPY/m <sup>2</sup>
Number of panel per package	2pieces
Coverage	1.38m <sup>2</sup> /piece
Weight	Approx. 23kg/piece

## Outside corner

Outside corner l=455

18×outside:93(inside:75)  
×455(exposed width)

## Accessories list

Genuine accessories are required to install siding panels

Panel	Accessories	Outside corner l=455	Caulking (Holder set: B80E)	Repair Paint
NH5641A		NHD5641A	B84302999	B97F2999AA
NH5642A		NHD5642A	B84304013	B97F3800AA
NH5643A		NHD5643A	B84301843	B97F3801AA
Price		<b>4,300 JPY/piece</b>	<b>6,600 JPY/piece</b>	<b>13,100 JPY/box</b>
Number of panel per package		10 pieces/box (Ordering Unit 1piece)	10 pieces/box <sup>*1</sup> (Ordering Unit 1piece) Caulking(600ml)10pieces, Primer,brush,nozzle2pieces <small>*Holder set are sold separately</small>	1 set/box Inorganic ever-drying type Paint Base(10g)2 kinds each,Hardener(7g)2pieces, Primer(7.5g)1piece, brush3pieces,felt stick2pieces

\*1 The dedicated primer (part number B85AA or B85BB) will be shipped at the same time.

# Contrast Border 18

Coating performance	Weather resistance	Installation
Photocatalytic Self-cleaning	Weather resistance grade ★★★	Installation Horizontal



NH5741A



NH5743A



NH5745A



NH5746A

## Specifications

Size	18×455(exposed width)×3030mm
Price	<b>10,200 JPY</b> /piece 7,400 JPY/m <sup>2</sup>
Number of panel per package	2pieces
Coverage	1.38m <sup>2</sup> /piece
Weight	Approx. 24kg/piece

## Outside corner



## Accessories list

Genuine accessories are required to install siding panels

Panel	Accessories				
	Outside corner l=455	Caulking (Holder set: B80E)	Repair Paint		
NH5741A	NHD5741A	B84302974	B96F2974AA	—	—
NH5743A	NHD5743A	B84303859	—	B97F2976AA	—
NH5745A	NHD5745A	B84302978	—	—	B98F2978AA
NH5746A	NHD5746A	B84302979	—	B97F2979AA	—
Price	<b>4,300 JPY</b> /piece	<b>6,600 JPY</b> /piece	<b>6,600 JPY</b> /box	<b>13,100 JPY</b> /box	<b>13,600 JPY</b> /box
Number of panel per package	10 pieces/box (Ordering Unit 1piece)	10 pieces/box*1 (Ordering Unit 1piece)	1 set/box	1 set/box	1 set/box
		Caulking(600ml)10pieces, Primer,brush,nozzle2pieces *Holder set are sold separately	Inorganic ever-drying type Paint Base(10g)1piece, Hardener(7g)1piece, Primer(7.5g)1piece, brush2pieces,felt stick1piece	Inorganic ever-drying type Paint Base(10g)2 kinds each, Hardener(7g)2pieces, Primer(7.5g)1piece, brush3pieces,felt stick2pieces	Inorganic ever-drying type Paint Base(10g)3 kinds each, Hardener(7g)3pieces, Primer(7.5g)1piece, brush4pieces,felt stick3pieces

\*1 The dedicated primer (part number B85AA or B85BB) will be shipped at the same time.

# Variosta

Coating performance	Weather resistance	Installation
Photocatalytic Self-cleaning	Weather resistance grade ★★★	Installation Horizontal



NH5901A



NH5902A



NH5903A

## Specifications

Size	18×455(exposed width)×3030mm
Price	<b>10,200 JPY</b> /piece 7,400 JPY/m <sup>2</sup>
Number of panel per package	2pieces
Coverage	1.38m <sup>2</sup> /piece
Weight	Approx. 23kg/piece

## Outside corner



## Accessories list

Genuine accessories are required to install siding panels

Panel	Accessories	Outside corner l=455	Caulking (Holder set: B80E)	Repair Paint	
NH5901A		NHD5901A	B84303990	B97F4096AA	—
NH5902A		NHD5902A	B84302946	—	B98F4097AA
NH5903A		NHD5903A	B84301843	B97F4098AA	—
Price		<b>4,300 JPY</b> /piece	<b>6,600 JPY</b> /piece	<b>13,100 JPY</b> /box	<b>13,600 JPY</b> /box
Number of panel per package	10 pieces/box (Ordering Unit 1piece)	10 pieces/box <sup>*1</sup> (Ordering Unit 1piece)		1 set/box	1 set/box
		Caulking(600ml)10pieces, Primer,brush,nozzle2pieces <small>*Holder set are sold separately</small>		Inorganic ever-drying type Paint Base(10g)2 kinds each,Hardener(7g)2pieces, Primer(7.5g)1piece, brush3pieces,felt stick2pieces	Inorganic ever-drying type Paint Base(10g)5 kinds each,Hardener(7g)3pieces, Primer(7.5g)1piece, brush4pieces,felt stick3pieces

\*1 The dedicated primer (part number B85AA or B85BB) will be shipped at the same time.

# Remare 18

Coating performance	Weather resistance	Installation
Photocatalytic Self-cleaning	Weather resistance grade ★★★	Installation Horizontal



NH5821A



NH5822A



NH5823A

## Specifications

Size	18×455(exposed width)×3030mm
Price	<b>10,200 JPY/piece</b> 7,400 JPY/m <sup>2</sup>
Number of panel per package	2pieces
Coverage	1.38m <sup>2</sup> /piece
Weight	Approx. 23kg/piece

## Outside corner

Outside corner l=455

18×outside:93(inside:75)  
×455(exposed width)

## Accessories list

Genuine accessories are required to install siding panels

Panel	Accessories	Outside corner l=455	Caulking (Holder set: B80E)	Repair Paint
NH5821A		NHD5821A	B84303827	B98F3827AA
NH5822A		NHD5822A	B84303828	B98F3828AA
NH5823A		NHD5823A	B84301846	B98F3829AA
Price		<b>4,300 JPY/piece</b>	<b>6,600 JPY/piece</b>	<b>13,600 JPY/box</b>
Number of panel per package		10 pieces/box (Ordering Unit 1piece)	10 pieces/box <sup>*1</sup> (Ordering Unit 1piece) Caulking(600ml)10pieces, Primer,brush,nozzle2pieces <small>*Holder set are sold separately</small>	1 set/box <small>Inorganic ever-drying type Paint Base(10g)3 kinds each,Hardener(7g)3pieces, Primer(7.5g)1piece, brush4pieces,felt stick3pieces</small>

\*1 The dedicated primer (part number B85AA or B85BB) will be shipped at the same time.

# Grat 18

Coating performance	Weather resistance	Installation
Photocatalytic Self-cleaning	Weather resistance grade ★★★	Installation Horizontal



NH5831A



NH5834A



NH5835A



NH5837A

## Specifications

Size	18×455(exposed width)×3030mm
Price	<b>10,200 JPY</b> /piece 7,400 JPY/m <sup>2</sup>
Number of panel per package	2pieces
Coverage	1.38m <sup>2</sup> /piece
Weight	Approx. 24kg/piece

## Outside corner

Outside corner l=455

18×outside:93(inside:75)  
×455(exposed width)

## Accessories list

Genuine accessories are required to install siding panels

Panel	Accessories	Outside corner l=455	Caulking (Holder set: B80E)	Repair Paint
NH5831A		NHD5831A	B84301807	B97F2992AA
NH5834A		NHD5834A	B84301810	B97F2995AA
NH5835A		NHD5835A	B84302996	B97F2996AA
NH5837A		NHD5837A	B84302867	B97F2998AA
Price		<b>4,300 JPY</b> /piece	<b>6,600 JPY</b> /piece	<b>13,100 JPY</b> /box
Number of panel per package		10 pieces/box (Ordering Unit 1piece)	10 pieces/box <sup>*1</sup> (Ordering Unit 1piece) Caulking(600ml)10pieces, Primer,brush,nozzle2pieces <small>*Holder set are sold separately</small>	1 set/box Inorganic ever-drying type Paint Base(10g)2 kinds each,Hardener(7g)2pieces, Primer(7.5g)1piece, brush3pieces,felt stick2pieces

<sup>\*1</sup> The dedicated primer (part number B85AA or B85BB) will be shipped at the same time.

# Millefeuille Tile 18

Coating performance	Weather resistance	Installation
Photocatalytic Self-cleaning	Weather resistance grade ★★★	Installation Horizontal



NH5751A



NH5752A



NH5753A



NH5754A

## Specifications

Size	18×455(exposed width)×3030mm
Price	<b>10,200 JPY/piece</b> 7,400 JPY/m <sup>2</sup>
Number of panel per package	2pieces
Coverage	1.38m <sup>2</sup> /piece
Weight	Approx. 22kg/piece

## Outside corner

Outside corner l=455

18×outside:93(inside:75)  
×455(exposed width)

## Accessories list

Genuine accessories are required to install siding panels

Panel	Accessories	Outside corner l=455	Caulking (Holder set: B80E)	Repair Paint
NH5751A		NHD5751A	B84303819	B98F3819AA
NH5752A		NHD5752A	B84302876	B98F3820AA
NH5753A		NHD5753A	B84303821	B98F3821AA
NH5754A		NHD5754A	B84303822	B98F3822AA
Price		<b>4,300 JPY/piece</b>	<b>6,600 JPY/piece</b>	<b>13,600 JPY/box</b>
Number of panel per package		10 pieces/box (Ordering Unit 1piece)	10 pieces/box <sup>*1</sup> (Ordering Unit 1piece) Caulking(600ml)10pieces, Primer,brush, nozzle2pieces <small>*Holder set are sold separately</small>	1 set/box Inorganic ever-drying type Paint Base(10g)3 kinds each,Hardener(7g)3pieces, Primer(7.5g)1piece, brush4pieces, felt stick3pieces

<sup>\*1</sup> The dedicated primer (part number B85AA or B85BB) will be shipped at the same time.

# Shatelet Brick 18

Coating performance	Weather resistance	Installation
Photocatalytic Self-cleaning	Weather resistance grade ★★★	Installation Horizontal



NH5671A



NH5672A



NH5673A



NH5674A

## Specifications

Size	18×455(exposed width)×3030mm
Price	<b>10,200 JPY/piece</b> 7,400 JPY/m <sup>2</sup>
Number of panel per package	2pieces
Coverage	1.38m <sup>2</sup> /piece
Weight	Approx. 23kg/piece

## Outside corner

Outside corner l=455

18×outside:93(inside:75)  
×455(exposed width)

## Accessories list

Genuine accessories are required to install siding panels

Panel	Accessories	Outside corner l=455	Caulking (Holder set: B80E)	Repair Paint	
NH5671A		NHD5671A	B8430428	B97F2947AA	—
NH5672A		NHD5672A	B84302948A	—	B98F2948AA
NH5673A		NHD5673A	B84302949A	B97F2949AA	—
NH5674A		NHD5674A	B84302952	—	B98F2950AA
Price		<b>4,300 JPY/piece</b>	<b>6,600 JPY/piece</b>	<b>13,100 JPY/box</b>	<b>13,600 JPY/box</b>
Number of panel per package	10 pieces/box (Ordering Unit 1piece)		10 pieces/box <sup>1)</sup> (Ordering Unit 1piece)	1 set/box	1 set/box
			Caulking(600ml)10pieces, Primer,brush,nozzle2pieces <small>*Holder set are sold separately</small>	Inorganic ever-drying type Paint Base(10g)2 kinds each,Hardener(7g)2pieces, Primer(7.5g)1piece, brush3pieces,felt stick2pieces	Inorganic ever-drying type Paint Base(10g)5 kinds each,Hardener(7g)3pieces, Primer(7.5g)1piece, brush4pieces,felt stick3pieces

<sup>1)</sup> The dedicated primer (part number B85AA or B85BB) will be shipped at the same time.



# Odd Cedar

Coating performance	Weather resistance	Installation
Photocatalytic Self-cleaning	Weather resistance grade ★★	Installation Horizontal and Vertical



NH5911A

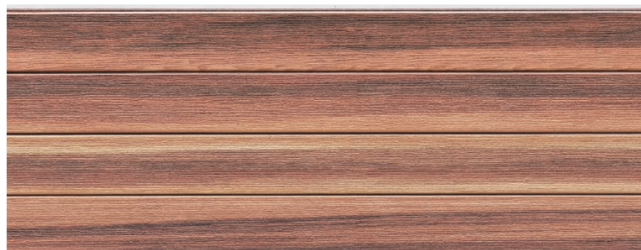

NH5912A



NH5913A

• Odd Cedar is a product in which a wide range of designs are randomly packaged under one product number.  
• It is a product that does not require consideration of wall layout, and will result in a random wall design with normal installation.

## Image

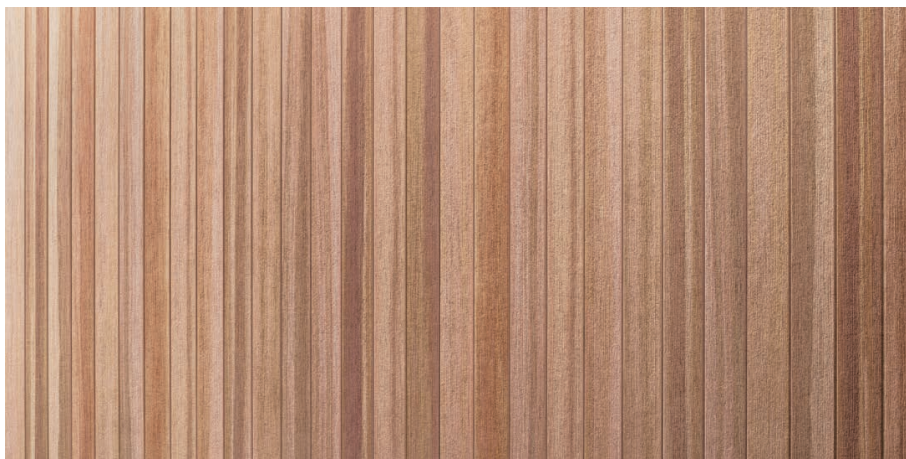

NH5911A



NH5912A

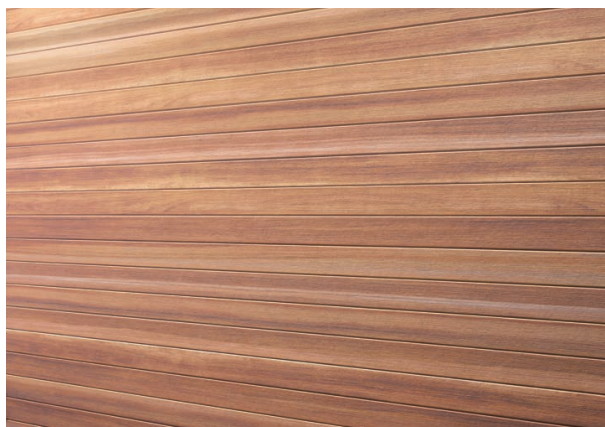

NH5913A



The pattern on the panel and the matching-preformed corner piece may not be perfectly aligned across the caulking line.  
Please consider using metal corner pieces (narrow shaped outside corner or W shaped outside corner) as an alternative.

## Specifications

Size	18×455(exposed width)×3030mm
Price	<b>10,200JPY/piece</b> 7,400JPY/m <sup>2</sup>
Number of panel per package	2pieces
Coverage	1.38m <sup>2</sup> /piece
Weight	Approx. 23kg/piece

## Outside corner

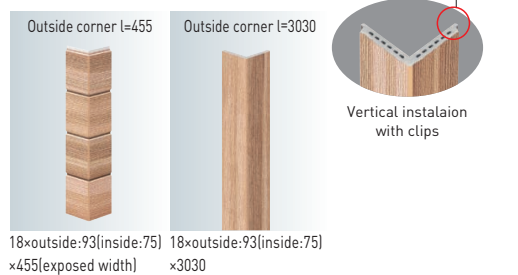

## Accessories list

Genuine accessories are required to install siding panels

Panel	Outside corner l=455	Outside corner l=3030	Through Wall Flashing l=3030	Caulking (Holder set: B80E)	Repair Paint
NH5911A	NHD5911A	NHP5911A	B2241525	B84304115	B98F4115BA
NH5912A	NHD5912A	NHP5912A	B2241476	B84304116	B98F4116BA
NH5913A	NHD5913A	NHP5913A	B2241423	B84304117	B98F4117BA
Price	<b>4,300JPY/piece</b>	<b>19,300JPY/piece</b>	<b>3,200JPY/piece</b>	<b>6,600JPY/piece</b>	<b>13,600JPY/box</b>
Number of panel per package	10 pieces/box (Ordering Unit 1piece)	1piece	5 pieces/box	10 pieces/box <sup>*1</sup> (Ordering Unit 1piece) Caulking(600ml)10pieces, Primer:brush,nozzle2pieces <small>*Holder set are sold separately</small>	1 set/box Inorganic ever-drying type Paint Base(10g)3 kinds each, Hardener(7g)3pieces, Primer(7.5g)1piece, brush4pieces,felt stick3pieces

\*1 The dedicated primer (part number B85AA or B85BB) will be shipped at the same time.

# Barn Wood 18

<b>Coating performance</b> Photocatalytic Self-cleaning	<b>Weather resistance</b> Weather resistance grade ★★★	<b>Installation</b> Installation Horizontal and Vertical
--	---	---



NH5771A



NH5772A



NH5773A



NH5774A



NH5775A



NH5776A

## Specifications

Size	18×455(exposed width)×3030mm
Price	<b>10,200JPY/piece</b> 7,400JPY/m <sup>2</sup>
Number of panel per package	2pieces
Coverage	1.38m <sup>2</sup> /piece
Weight	Approx. 25kg/piece

## Outside corner

Outside corner l=455



18×outside:93(inside:75)  
×455(exposed width)

Outside corner l=3030



18×outside:93(inside:75)  
×3030

Shiplap corner



Vertical installation with clips

## Accessories list

Genuine accessories are required to install siding panels

Panel	Accessories		Through Wall Flashing l=3030	Caulking (Holder set: B80E)	Repair Paint	
	Outside corner l=455	Outside corner l=3030				
NH5771A	NHD5771A	NHP5771A	B2241557	B84302980	B97F2980AA	—
NH5772A	NHD5772A	NHP5772A	B22413113	B84302831	B97F2981AA	—
NH5773A	NHD5773A	NHP5773A	B2241W3	B84302982	B97F2982AA	—
NH5774A	NHD5774A	NHP5774A	B2241441	B84302864	—	B98F2983AA
NH5775A	NHD5775A	NHP5775A	B22413113	B84302865	—	B98F2984AA
NH5776A	NHD5776A	NHP5776A	B2241460	B84304099	—	B98F4099AA
Price	<b>4,300JPY/piece</b>	<b>19,300JPY/piece</b>	<b>3,200JPY/piece</b>	<b>6,600JPY/piece</b>	<b>13,100JPY/box</b>	<b>13,600JPY/box</b>
Number of panel per package	10 pieces/box (Ordering Unit 1piece)	1piece	5 pieces/box	10 pieces/box <sup>*1</sup> (Ordering Unit 1piece)	1 set/box	1 set/box
				Caulking(600ml)10pieces, Primer,brush,nozzle2pieces	Inorganic ever-drying type Paint Base(10g)2 kinds each, Hardener(7g)2pieces, Primer(7.5g)1piece, brush3pieces,felt stick2pieces	Inorganic ever-drying type Paint Base(10g)3 kinds each, Hardener(7g)3pieces, Primer(7.5g)1piece, brush4pieces,felt stick3pieces

\*1 The dedicated primer (part number B85AA or B85BB) will be shipped at the same time.

# Brulee Wood 18

<b>Coating performance</b> Photocatalytic Self-cleaning	<b>Weather resistance</b> Weather resistance grade ★★★	<b>Installation</b> Installation Horizontal and Vertical
--	---	---



NH5685A



NH5686A



NH5687A



NH5689A

## Specifications

Size	18×455(exposed width)×3030mm
Price	<b>10,200JPY/piece</b> 7,400JPY/m <sup>2</sup>
Number of panel per package	2pieces
Coverage	1.38m <sup>2</sup> /piece
Weight	Approx. 23kg/piece

## Outside corner

Outside corner l=455      Outside corner l=3030      Shiplap corner

Vertical installation with clips

18×outside:93(inside:75) ×455(exposed width)      18×outside:93(inside:75) ×3030

## Accessories list

Genuine accessories are required to install siding panels

Panel	Accessories		Through Wall Flashing l=3030	Caulking (Holder set: B80E)	Repair Paint	
	Outside corner l=455	Outside corner l=3030				
NH5685A	NHD5685A	NHP5685A	B2241557	B84302955	B97F2955AA	—
NH5686A	NHD5686A	NHP5686A	B22412606	B84302956A	B97F2956AA	—
NH5687A	NHD5687A	NHP5687A	B2241427	B84303940	B97F3940AA	—
NH5689A	NHD5689A	NHP5689A	B22413114	B84302415	—	B98F3953AA
Price	<b>4,300JPY/piece</b>	<b>19,300JPY/piece</b>	<b>3,200JPY/piece</b>	<b>6,600JPY/piece</b>	<b>13,100JPY/box</b>	<b>13,600JPY/box</b>
Number of panel per package	10 pieces/box (Ordering Unit 1piece)	1piece	5 pieces/box	10 pieces/box <sup>*1</sup> (Ordering Unit 1piece) Caulking(400m)110pieces, Primer,brush,nozzle2pieces <small>*Holder set are sold separately</small>	1 set/box Inorganic ever-drying type Paint Base(10g)2 kinds each, Hardener(7g)2pieces, Primer(7.5g)1piece, brush3pieces,felt stick2pieces	1 set/box Inorganic ever-drying type Paint Base(10g)3 kinds each, Hardener(7g)3pieces, Primer(7.5g)1piece, brush4pieces,felt stick3pieces

\*1 The dedicated primer (part number B85AA or B85BB) will be shipped at the same time.

# Board Formed Concrete 18

<b>Coating performance</b> Photocatalytic Self-cleaning	<b>Weather resistance</b> Weather resistance grade ★★★	<b>Installation</b> Installation Horizontal and Vertical
--	---	---



NH5761A



NH5762A



NH5763A



NH5764A

## Specifications

Size	18×455(exposed width)×3030mm
Price	<b>10,200 JPY/piece</b> 7,400 JPY/m <sup>2</sup>
Number of panel per package	2 pieces
Coverage	1.38m <sup>2</sup> /piece
Weight	Approx. 24kg/piece

## Outside corner

Outside corner l=455



18×outside:93(inside:75) ×455(exposed width)

Outside corner l=3030



18×outside:93(inside:75) ×3030

Shiplap corner



Vertical installation with clips

## Accessories list

Genuine accessories are required to install siding panels

Panel	Accessories		Through Wall Flashing l=3030	Caulking (Holder set: B80E)	Repair Paint	
	Outside corner l=455	Outside corner l=3030				
NH5761A	NHD5761A	NHP5761A	B2241557	B84302879	B97F3823AA	—
NH5762A	NHD5762A	NHP5762A	B2241557	B84302880	B97F3824AA	—
NH5763A	NHD5763A	NHP5763A	B2241550	B84301823	B97F3825AA	—
NH5764A	NHD5764A	NHP5764A	B2241557	B84301823	—	B98F3826AA
Price	<b>4,300 JPY/piece</b>	<b>19,300 JPY/piece</b>	<b>3,200 JPY/piece</b>	<b>6,600 JPY/piece</b>	<b>13,100 JPY/box</b>	<b>13,600 JPY/box</b>
Number of panel per package	10 pieces/box (Ordering Unit 1piece)	1piece	5 pieces/box	10 pieces/box <sup>*1</sup> (Ordering Unit 1piece) Caulking(600ml)10pieces, Primer,brush,nozzle2pieces <small>*Holder set are sold separately</small>	1 set/box Inorganic ever-drying type Paint Base(10g)2 kinds each, Hardener(7g)3pieces, Primer(7.5g)1piece, brush3pieces,felt stick2pieces	1 set/box Inorganic ever-drying type Paint Base(10g)3 kinds each, Hardener(7g)3pieces, Primer(7.5g)1piece, brush4pieces,felt stick3pieces

\*1 The dedicated primer (part number B85AA or B85BB) will be shipped at the same time.



# Suranang

Coating performance	Weather resistance	Installation
Photocatalytic Self-cleaning	Weather resistance grade ★★★	Installation Horizontal and Vertical



NH5941A



NH5942A



NH5943A



NH5944A



NH5945A



NH5946A



NH5947A

## ■ Specifications

Size	18×455(exposed width)×3030mm
Price	<b>10,200JPY/piece</b> 7,400JPY/m <sup>2</sup>
Number of panel per package	2pieces
Coverage	1.38m <sup>2</sup> /piece
Weight	Approx. 24kg/piece

## ■ Outside corner

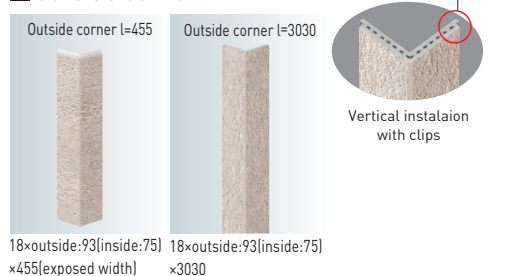

## ■ Accessories list

Genuine accessories are required to install siding panels

Panel	Accessories					
	Outside corner l=455	Outside corner l=3030	Through Wall Flashing l=3030	Caulking (Holder set: B80E)	Repair Paint	
NH5941A	NHD5941A	NHP5941A	B2241417	B84304183	B96F4183AA	—
NH5942A	NHD5942A	NHP5942A	B2241417	B84304184	B96F4184AA	—
NH5943A	NHD5943A	NHP5943A	B2241549	B84301843	—	B97F4185AA
NH5944A	NHD5944A	NHP5944A	B22413114	B84304186	B96F4186AA	—
NH5945A	NHD5945A	NHP5945A	B2241557	B84304043	—	B97F4187AA
NH5946A	NHD5946A	NHP5946A	B2241550	B84301843	—	B97F4188AA
NH5947A	NHD5947A	NHP5947A	B2241549	B84304101	—	B97F4195AA
Price	<b>4,300JPY/piece</b>	<b>19,300JPY/piece</b>	<b>3,200JPY/piece</b>	<b>6,600JPY/piece</b>	<b>6,600JPY/box</b>	<b>13,100JPY/box</b>
Number of panel per package	10 pieces/box (Ordering Unit 1piece)	1piece	5 pieces/box	10 pieces/box* (Ordering Unit 1piece) Caulking(600ml)10pieces, Primer,brush, nozzle2pieces *Holder set are sold separately	1 set/box Inorganic ever-drying type Paint Base(10g)1piece, Hardener(7g)1piece, Primer(7.5g)1piece, brush2pieces, felt stick1piece	1 set/box Inorganic ever-drying type Paint Base(10g)2 kinds each, Hardener(7g)2pieces, Primer(7.5g)1piece, brush3pieces, felt stick2pieces

\*1 The dedicated primer (part number B85AA or B85BB) will be shipped at the same time.

# Oval Stone

Coating performance	Weather resistance	Installation
Photocatalytic Self-cleaning	Weather resistance grade ★★★	Installation Horizontal



NH5701U



NH5702U



NH5703U



NH5704U

## Specifications

Size	18×455(exposed width)×3030mm
Price	<b>9,500JPY</b> /piece 6,890JPY/m <sup>2</sup>
Number of panel per package	2pieces
Coverage	1.38m <sup>2</sup> /piece
Weight	Approx. 24kg/piece

## Outside corner



## Accessories list

Genuine accessories are required to install siding panels

Panel	Accessories	Outside corner l=455	Caulking (Holder set: B80E)	Repair Paint
NH5701U		NHD5701U	B84302873	B97L3973AU
NH5702U		NHD5702U	B84302939	B97L3974AU
NH5703U		NHD5703U	B8430743	B97L3975AU
NH5704U		NHD5704U	B8430713	B97L3976AU
Price		<b>4,100JPY</b> /piece	<b>6,600JPY</b> /piece	<b>13,100JPY</b> /box
Number of panel per package		10 pieces/box (Ordering Unit 1piece)	10 pieces/box <sup>*1</sup> (Ordering Unit 1piece) Caulking(600ml)10pieces, Primer,brush,nozzle2pieces <small>*Holder set are sold separately</small>	1 set/box Inorganic ever-drying type Paint Base(10g)2 kinds each, Hardener(7g)2pieces, Primer(7.5g)1piece,brush3pieces

\*1 The dedicated primer (part number B85AA or B85BB) will be shipped at the same time.



# Float Bar

Coating performance	Weather resistance	Installation
Photocatalytic Self-cleaning	Weather resistance grade ★★★	Installation Horizontal



NH5861U



NH5862U



NH5863U



NH5864U



## ■ Specifications

Size	18×455(exposed width)×3030mm
Price	<b>9,500JPY/piece</b> 6,890JPY/m <sup>2</sup>
Number of panel per package	2pieces
Coverage	1.38m <sup>2</sup> /piece
Weight	Approx. 24kg/piece

## ■ Outside corner



## ■ Accessories list

Genuine accessories are required to install siding panels

Panel	Accessories	Outside corner l=455	Caulking (Holder set: B80E)	Repair Paint
NH5861U		NHD5861U	B84302491	B96L3106CU
NH5862U		NHD5862U	B84303990	B96L3104BU
NH5863U		NHD5863U	B8430719A	B96L3354AU
NH5864U		NHD5864U	B8430743	B96L3112AU
Price		<b>4,100JPY/piece</b>	<b>6,600JPY/piece</b>	<b>6,600JPY/box</b>
Number of panel per package		10 pieces/box (Ordering Unit 1piece)	10 pieces/box <sup>*1</sup> (Ordering Unit 1piece) Caulking(600ml)10pieces, Primer,brush,nozzle2pieces <small>*Holder set are sold separately</small>	1 set/box Inorganic ever-drying type Paint Base(10g)1piece, Hardener(7g)1piece, Primer(7.5g)1piece,brush2pieces

\*1 The dedicated primer (part number B85AA or B85BB) will be shipped at the same time.

# Garland Tile

Coating performance	Weather resistance	Installation
Photocatalytic Self-cleaning	Weather resistance grade ★★★	Installation Horizontal



NH5281U



NH5282U



NH5284U

## Specifications

Size	18×455(exposed width)×3030mm
Price	<b>9,500JPY</b> /piece 6,890JPY/m <sup>2</sup>
Number of panel per package	2pieces
Coverage	1.38m <sup>2</sup> /piece
Weight	Approx. 23kg/piece

## Outside corner

Outside corner l=455

18×outside:93(inside:75)  
×455(exposed width)

## Accessories list

Genuine accessories are required to install siding panels

Panel	Accessories	Outside corner l=455	Caulking (Holder set: B80E)	Repair Paint
NH5281U		NHD5281U	B8430495	B972922AU
NH5282U		NHD5282U	B8430903	B972923AU
NH5284U		NHD5284U	B84302503	B972925AU
Price		<b>4,100JPY</b> /piece	<b>6,600JPY</b> /piece	<b>13,100JPY</b> /box
Number of panel per package		10 pieces/box (Ordering Unit 1piece)	10 pieces/box <sup>1)</sup> (Ordering Unit 1piece) Caulking(600ml)10pieces, Primer,brush,nozzle2pieces <small>*Holder set are sold separately</small>	1 set/box Inorganic ever-drying type Paint Base(9g)2 kinds each, Hardener(7g)2pieces, Primer(7.5g)1piece,brush3pieces

<sup>1</sup> The dedicated primer (part number B85AA or B85BB) will be shipped at the same time.

# Farbe Stone

Coating performance	Weather resistance	Installation
Photocatalytic Self-cleaning	Weather resistance grade ★★★	Installation Horizontal



NH5711U



NH5712U



NH5713U



NH5714U



NH5715U

## Specifications

Size	18×455(exposed width)×3030mm
Price	<b>9,500JPY</b> /piece 6,890JPY/m <sup>2</sup>
Number of panel per package	2pieces
Coverage	1.38m <sup>2</sup> /piece
Weight	Approx. 23kg/piece

## Outside corner



## Accessories list

Genuine accessories are required to install siding panels

Panel	Accessories	Outside corner l=455	Caulking (Holder set: B80E)	Repair Paint	
NH5711U		NHD5711U	B8430495	B97L3977AU	—
NH5712U		NHD5712U	B8430746	B97L3978AU	—
NH5713U		NHD5713U	B84303979	—	B98L3979AU
NH5714U		NHD5714U	B84302417	—	B98L3980AU
NH5715U		NHD5715U	B84303045	B97L3981AU	—
Price		<b>4,100JPY</b> /piece	<b>6,600JPY</b> /piece	<b>13,100JPY</b> /box	<b>13,600JPY</b> /box
Number of panel per package	10 pieces/box (Ordering Unit 1piece)	10 pieces/box <sup>*1</sup> (Ordering Unit 1piece)	Caulking(600ml)10pieces, Primer,brush,nozzle2pieces <small>*Holder set are sold separately</small>	1 set/box	1 set/box
				Inorganic ever-drying type Paint Base(10g)2 kinds each, Hardener(7g)2pieces, Primer(7.5g)1piece,brush3pieces	Inorganic ever-drying type Paint Base(10g)3 kinds each, Hardener(7g)3pieces, Primer(7.5g)1piece,brush4pieces

\*1 The dedicated primer (part number B85AA or B85BB) will be shipped at the same time.

# New Layer Relief 18

Coating performance	Weather resistance	Installation
Photocatalytic Self-cleaning	Weather resistance grade ★★★	Installation Horizontal



NH5542K



NH5546K



NH5547K

## Specifications

Size	18×455(exposed width)×3030mm
Price	<b>9,500JPY</b> /piece 6,890JPY/m <sup>2</sup>
Number of panel per package	2pieces
Coverage	1.38m <sup>2</sup> /piece
Weight	Approx. 23kg/piece

## Outside corner

Outside corner l=455

18×outside:93(inside:75)  
×455(exposed width)

## Accessories list

Genuine accessories are required to install siding panels

Panel	Accessories			
	Outside corner l=455	Caulking (Holder set: B80E)	Repair Paint	
NH5542K	NHD5542K	B8430408	—	B97L3805AK
NH5546K	NHD5546K	B8430495	B96L3149AK	—
NH5547K	NHD5547K	B84302417	—	B97L3808AK
Price	<b>4,100JPY</b> /piece	<b>6,600JPY</b> /piece	<b>6,600JPY</b> /box	<b>13,100JPY</b> /box
Number of panel per package	10 pieces/box (Ordering Unit 1piece)	10 pieces/box <sup>*1</sup> (Ordering Unit 1piece)	1 set/box	1 set/box
		Caulking(600ml)10pieces, Primer,brush,nozzle2pieces <small>*Holder set are sold separately</small>	Inorganic ever-drying type Paint Base(10g)1piece,Hardener(7g)1piece, Primer(7.5g)1piece,brush2pieces	Inorganic ever-drying type Paint Base(10g)2 kinds each,Hardener(7g)2pieces, Primer(7.5g)1piece,brush3pieces

\*1 The dedicated primer (part number B85AA or B85BB) will be shipped at the same time.

# Maree Stone 18

Coating performance	Weather resistance	Installation
Photocatalytic Self-cleaning	Weather resistance grade ★★	Installation Horizontal



NH5461K



NH5462K



NH5464K



NH5465K



NH5467K

## Specifications

Size	18×455(exposed width)×3030mm
Price	<b>9,500JPY</b> /piece 6,890JPY/m <sup>2</sup>
Number of panel per package	2pieces
Coverage	1.38m <sup>2</sup> /piece
Weight	Approx. 23kg/piece

## Outside corner

Outside corner l=455

18×outside:93(inside:75)  
×455(exposed width)

## Accessories list

Genuine accessories are required to install siding panels

Panel	Accessories	Outside corner l=455	Caulking (Holder set: B80E)	Repair Paint	
NH5461K		NHD5461K	B8430495	B96L3149AK	—
NH5462K		NHD5462K	B84303003A	—	B97L3842AK
NH5464K		NHD5464K	B84302417	—	B97L3844AK
NH5465K		NHD5465K	B8430713	B96L3182AK	—
NH5467K		NHD5467K	B84302933	B96L3846AK	—
Price		<b>4,100JPY</b> /piece	<b>6,600JPY</b> /piece	<b>6,600JPY</b> /box	<b>13,100JPY</b> /box
Number of panel per package	10 pieces/box (Ordering Unit 1piece)		10 pieces/box <sup>*1</sup> (Ordering Unit 1piece)	1 set/box	1 set/box
			Caulking(600ml)10pieces, Primer,brush,nozzle2pieces <small>*Holder set are sold separately</small>	Inorganic ever-drying type Paint Base(10g)1piece,Hardener(7g)1piece, Primer(7.5g)1piece,brush2pieces	Inorganic ever-drying type Paint Base(10g)2 kinds each,Hardener(7g)2pieces, Primer(7.5g)1piece,brush3pieces

\*1 The dedicated primer (part number B85AA or B85BB) will be shipped at the same time.

# New Ridge Wave 18

Coating performance Photocatalytic Self-cleaning	Weather resistance Weather resistance grade ★★★	Installation Installation Horizontal
---	--	---



NH5551K



NH5552K



NH5554K



NH5555K



NH5556K

## Specifications

Size	18×455(exposed width)×3030mm
Price	<b>9,500JPY</b> /piece 6,890JPY/m <sup>2</sup>
Number of panel per package	2pieces
Coverage	1.38m <sup>2</sup> /piece
Weight	Approx. 23kg/piece

## Outside corner



## Accessories list

Genuine accessories are required to install siding panels

Panel	Accessories	Outside corner l=455	Caulking (Holder set: B80E)	Repair Paint
NH5551K		NHD5551K	B8430428	B97L3906AK
NH5552K		NHD5552K	B84302873	B97L3907AK
NH5554K		NHD5554K	B84302910A	B97L3909AK
NH5555K		NHD5555K	B84302491C	B97L3967AK
NH5556K		NHD5556K	B8430713	B97L3968AK
Price		<b>4,100JPY</b> /piece	<b>6,600JPY</b> /piece	<b>13,100JPY</b> /box
Number of panel per package		10 pieces/box (Ordering Unit 1piece)	10 pieces/box <sup>1</sup> (Ordering Unit 1piece) Caulking(600ml)10pieces, Primer,brush, nozzle2pieces <small>*Holder set are sold separately</small>	1 set/box <small>Inorganic ever-drying type Paint Base(10g)2 kinds each,Hardener(7g)2pieces, Primer(7.5g)1piece,brush3pieces</small>

<sup>1</sup>The dedicated primer (part number B85AA or B85BB) will be shipped at the same time.

# Harmoride

Coating performance Photocatalytic Self-cleaning	Weather resistance Weather resistance grade ★★★	Installation Installation Horizontal
---	---	--



G NH5201A  
H NH5201U  
F NH5201K



G NH5202A  
H NH5202U  
F NH5202K



G NH5203A  
H NH5203U  
F NH5203K



G NH5204A  
H NH5204U  
F NH5204K



G NH5205A  
H NH5205U  
F NH5205K



G NH5206A  
H NH5206U  
F NH5206K

## Specifications

Size	18×455(exposed width)×3030mm
Price	9,500JPY/piece 6,890JPY/m <sup>2</sup>
Number of panel per package	2pieces
Coverage	1.38m <sup>2</sup> /piece
Weight	Approx. 23kg/piece

## Outside corner



## Accessories list

Genuine accessories are required to install siding panels

Panel	Accessories	Outside corner l=455	Caulking (Holder set: B80E)	Repair Paint
G	NH5201A	NHD5201A	B8430495	B96L1620BA
	NH5202A	NHD5202A	B84304040	B96L2525CU
	NH5203A	NHD5203A	B84302417	B96L2618CU
	NH5204A	NHD5204A	B8430713	B96L2632HU
	NH5205A	NHD5205A	B84302546	B96L3143EK
	NH5206A	NHD5206A	B84301823A	B96L2636DA
H	NH5201U	NHD5201U	B8430495	B96L1620CU
	NH5202U	NHD5202U	B84304040	B96L2525CU
	NH5203U	NHD5203U	B84302417	B96L2618CU
	NH5204U	NHD5204U	B8430713	B96L2632DU
	NH5205U	NHD5205U	B84302546	B96L3143EK
	NH5206U	NHD5206U	B84301823A	B96L2636DA
F	NH5201K	NHD5201K	B8430495	B96L3149AK
	NH5202K	NHD5202K	B84304040	B96L3156BK
	NH5203K	NHD5203K	B84302417	B96L3155AK
	NH5204K	NHD5204K	B8430713	B96L3182AK
	NH5205K	NHD5205K	B84302546	B96L3143EK
	NH5206K	NHD5206K	B84301823	B96L3180BK
Price	4,100JPY/piece	6,600JPY/piece	6,600JPY/box	
Number of panel per package	10 pieces/box (Ordering Unit 1piece)	10 pieces/box*1 (Ordering Unit 1piece) Caulking(600ml)10pieces, Primer,brush,nozzle2pieces *Holder set are sold separately	1 set/box Inorganic ever-drying type Paint Base(10g)1piece,Hardener(7g)1piece, Primer(7.5g)1piece,brush2pieces	

\*1 The dedicated primer (part number B85AA or B85BB) will be shipped at the same time.

# Chic Border 18

Coating performance	Weather resistance	Installation
Photocatalytic Self-cleaning	Weather resistance grade ★★★	Installation Horizontal



NH5561K



NH5562K



NH5564K

## Specifications

Size	18×455(exposed width)×3030mm
Price	<b>9,500JPY</b> /piece 6,890JPY/m <sup>2</sup>
Number of panel per package	2pieces
Coverage	1.38m <sup>2</sup> /piece
Weight	Approx. 22kg/piece

## Outside corner

Outside corner l=455

18×outside:93(inside:75)  
×455(exposed width)

## Accessories list

Genuine accessories are required to install siding panels

Panel	Accessories			
	Outside corner l=455	Caulking (Holder set: B80E)	Repair Paint	
NH5561K	NHD5561K	B8430495	B96L3149AK	—
NH5562K	NHD5562K	B8430409	—	B97L3806CK
NH5564K	NHD5564K	B8430713	—	B97L3810BK
Price	<b>4,100JPY</b> /piece	<b>6,600JPY</b> /piece	<b>6,600JPY</b> /box	<b>13,100JPY</b> /box
Number of panel per package	10 pieces/box (Ordering Unit 1piece)	10 pieces/box <sup>1)</sup> (Ordering Unit 1piece)	1 set/box	1 set/box
		Caulking(600ml)10pieces, Primer,brush,nozzle2pieces <small>*Holder set are sold separately</small>	Inorganic ever-drying type Paint Base(10g)1piece,Hardener(7g)1piece, Primer(7.5g)1piece,brush2pieces	Inorganic ever-drying type Paint Base(10g)2 kinds each,Hardener(7g)2pieces, Primer(7.5g)1piece,brush3pieces

<sup>1)</sup> The dedicated primer (part number B85AA or B85BB) will be shipped at the same time.

# Dilectone 18

Coating performance	Weather resistance	Installation
Photocatalytic Self-cleaning	Weather resistance grade ★★★	Installation Horizontal



NH5451K



NH5455K



NH5456K



NH5457K

## Specifications

Size	18×455(exposed width)×3030mm
Price	<b>9,500JPY</b> /piece 6,890JPY/m <sup>2</sup>
Number of panel per package	2pieces
Coverage	1.38m <sup>2</sup> /piece
Weight	Approx. 23kg/piece

## Outside corner

Outside corner l=455

18×outside:93(inside:75)  
×455(exposed width)

## Accessories list

Genuine accessories are required to install siding panels

Panel	Accessories	Outside corner l=455	Caulking (Holder set: B80E)	Repair Paint
NH5451K		NHD5451K	B8430746	B96L3143AK
NH5455K		NHD5455K	B84302546	B96L3149CK
NH5456K		NHD5456K	B84302623	B96L3157AK
NH5457K		NHD5457K	B8430969	B96L3150BK
Price		<b>4,100JPY</b> /piece	<b>6,600JPY</b> /piece	<b>6,600JPY</b> /box
Number of panel per package		10 pieces/box (Ordering Unit 1piece)	10 pieces/box <sup>*1</sup> (Ordering Unit 1piece) Caulking(600ml)10pieces, Primer,brush,nozzle2pieces <small>*Holder set are sold separately</small>	1 set/box Inorganic ever-drying type Paint Base(10g)1piece,Hardener(7g)1piece, Primer(7.5g)1piece,brush2pieces

\*1 The dedicated primer (part number B85AA or B85BB) will be shipped at the same time.

# Natural Brick 18

Coating performance	Weather resistance	Installation
Photocatalytic Self-cleaning	Weather resistance grade ★★★	Installation Horizontal



NH5571U



NH5572U



NH5573U



NH5574U



NH5575U



NH5576U

## Specifications

Size	18×455(exposed width)×3030mm
Price	<b>9,500JPY</b> /piece 6,890JPY/m <sup>2</sup>
Number of panel per package	2pieces
Coverage	1.38m <sup>2</sup> /piece
Weight	Approx. 23kg/piece

## Outside corner

Outside corner l=455

18×outside:93(inside:75)  
×455(exposed width)

## Accessories list

Genuine accessories are required to install siding panels

Panel	Accessories				
	Outside corner l=455	Caulking (Holder set: B80E)	Repair Paint		
NH5571U	NHD5571U	B84302491A	—	B97L3959AU	—
NH5572U	NHD5572U	B8430746	—	—	B98L3960AU
NH5573U	NHD5573U	B8430427	—	—	B98L3961AU
NH5574U	NHD5574U	B84302503	—	—	B98L3962AU
NH5575U	NHD5575U	B84302491C	B96L2670HA	—	—
NH5576U	NHD5576U	B8430746	—	B97L992CA	—
Price	<b>4,100JPY</b> /piece	<b>6,600JPY</b> /piece	<b>6,600JPY</b> /piece	<b>13,100JPY</b> /box	<b>13,600JPY</b> /box
Number of panel per package	10 pieces/box (Ordering Unit 1piece)	10 pieces/box <sup>*1</sup> (Ordering Unit 1piece)	1 set/box	1 set/box	1 set/box
		Caulking(600ml)10pieces, Primer,brush,nozzle2pieces <small>*Holder set are sold separately</small>	Inorganic ever-drying type Paint Base(10g)1piece, Hardener(7g)1piece, Primer(7.5g)1piece,brush2pieces	Inorganic ever-drying type Paint Base(10g)2 kinds each, Hardener(7g)2pieces, Primer(7.5g)1piece,brush3pieces	Inorganic ever-drying type Paint Base(10g)3 kinds each, Hardener(7g)3pieces, Primer(7.5g)1piece,brush4pieces

\*1 The dedicated primer (part number B85AA or B85BB) will be shipped at the same time.

# Drawer Tile 18

Coating performance	Weather resistance	Installation
Photocatalytic Self-cleaning	Weather resistance grade ★★★	Installation Horizontal



NH5581U



NH5582U



NH5583U



NH5584U

## Specifications

Size	18×455(exposed width)×3030mm
Price	<b>9,500JPY</b> /piece 6,890JPY/m <sup>2</sup>
Number of panel per package	2pieces
Coverage	1.38m <sup>2</sup> /piece
Weight	Approx. 25kg/piece

## Outside corner

Outside corner l=455

18×outside:93(inside:75)  
×455(exposed width)

## Accessories list

Genuine accessories are required to install siding panels

Panel	Accessories	Outside corner l=455	Caulking (Holder set: B80E)	Repair Paint	
NH5581U		NHD5581U	B84303963	B97L3963AU	—
NH5582U		NHD5582U	B84303941	—	B98L3964AU
NH5583U		NHD5583U	B84302417B	—	B98L3965AU
NH5584U		NHD5584U	B8430713	B97L3966AU	—
Price		<b>4,100JPY</b> /piece	<b>6,600JPY</b> /piece	<b>13,100JPY</b> /box	<b>13,600JPY</b> /box
Number of panel per package	10 pieces/box (Ordering Unit 1piece)		10 pieces/box <sup>*1</sup> (Ordering Unit 1piece)	1 set/box	1 set/box
			Caulking(600ml)10pieces, Primer,brush,nozzle2pieces <small>*Holder set are sold separately</small>	Inorganic ever-drying type Paint Base(10g)2 kinds each, Hardener(7g)2pieces, Primer(7.5g)1piece,brush3pieces	Inorganic ever-drying type Paint Base(10g)3 kinds each, Hardener(7g)3pieces, Primer(7.5g)1piece,brush4pieces

\*1 The dedicated primer (part number B85AA or B85BB) will be shipped at the same time.

# Raster Tile

Coating performance	Weather resistance	Installation
Photocatalytic Self-cleaning	Weather resistance grade ★★	Installation Horizontal



NH5851U



NH5852U



NH5853U



NH5854U

## Specifications

Size	18×455(exposed width)×3030mm
Price	<b>9,500JPY</b> /piece 6,890JPY/m <sup>2</sup>
Number of panel per package	2pieces
Coverage	1.38m <sup>2</sup> /piece
Weight	Approx. 23kg/piece

## Outside corner

Outside corner l=455

18×outside:93(inside:75)  
×455(exposed width)

## Accessories list

Genuine accessories are required to install siding panels

Panel	Accessories	Outside corner l=455	Caulking (Holder set: B80E)	Repair Paint
NH5851U		NHD5851U	B84303051	B96G4060AU
NH5852U		NHD5852U	B84302546	B96G4061AU
NH5853U		NHD5853U	B84303212	B96G4062AU
NH5854U		NHD5854U	B8430719A	B96G4063AU
Price		<b>4,100JPY</b> /piece	<b>6,600JPY</b> /piece	<b>6,600JPY</b> /box
Number of panel per package		10 pieces/box (Ordering Unit 1piece)	10 pieces/box <sup>*1</sup> (Ordering Unit 1piece) Caulking(600ml)10pieces, Primer,brush, nozzle2pieces	1 set/box Inorganic ever-drying type Paint Base(5.5g)1piece,Hardener(7g)1piece, Primer(7.5g)1piece,brush2pieces

\*1 The dedicated primer (part number B85AA or B85BB) will be shipped at the same time.

# Composition

Coating performance	Weather resistance	Installation
Photocatalytic Self-cleaning	Weather resistance grade ★★★	Installation Horizontal



NH5271U



NH5273U



NH5274U

## Specifications

Size	18×455(exposed width)×3030mm
Price	<b>9,500JPY</b> /piece 6,890JPY/m <sup>2</sup>
Number of panel per package	2pieces
Coverage	1.38m <sup>2</sup> /piece
Weight	Approx. 24kg/piece

## Outside corner

Outside corner l=455

18×outside:93(inside:75)  
×455(exposed width)

## Accessories list

Genuine accessories are required to install siding panels

Panel	Accessories	Outside corner l=455	Caulking (Holder set: B80E)	Repair Paint
NH5271U		NHD5271U	B84302918	B972918AU
NH5273U		NHD5273U	B84302920	B972920AU
NH5274U		NHD5274U	B8430743	B972921AU
Price		<b>4,100JPY</b> /piece	<b>6,600JPY</b> /piece	<b>13,100JPY</b> /box
Number of panel per package		10 pieces/box (Ordering Unit 1piece)	10 pieces/box <sup>*1</sup> (Ordering Unit 1piece) Caulking(600ml)10pieces, Primer,brush,nozzle2pieces	1 set/box Inorganic ever-drying type Paint Base(9g)2 kinds each, Hardener(7g)2pieces, Primer(7.5g)1piece,brush3pieces

\*1 The dedicated primer (part number B85AA or B85BB) will be shipped at the same time.

# Urban Cedar 18

<b>Coating performance</b> Photocatalytic Self-cleaning	<b>Weather resistance</b> Weather resistance grade ★★★	<b>Installation</b> Installation Horizontal and Vertical
--	---	---



NH5532U



NH5533U



NH5534U



NH5535U

## Specifications

Size	18×455(exposed width)×3030mm
Price	<b>9,500JPY</b> /piece 6,890JPY/m <sup>2</sup>
Number of panel per package	2pieces
Coverage	1.38m <sup>2</sup> /piece
Weight	Approx. 25kg/piece

## Outside corner

Outside corner l=455



18×outside:93(inside:75) ×455(exposed width)

Outside corner l=3030



18×outside:93(inside:75) ×3030

Shiplap corner



Vertical installation with clips

## Accessories list

Genuine accessories are required to install siding panels

Panel	Accessories		Through Wall Flashing l=3030	Caulking (Holder set: B80E)	Repair Paint	
	Outside corner l=455	Outside corner l=3030				
NH5532U	NHD5532U	NHP5532U	B22412606	B84303925	—	B98L3955AU
NH5533U	NHD5533U	NHP5533U	B22412606	B84302833	B97L3956AU	—
NH5534U	NHD5534U	NHP5534U	B22413114	B8430707	—	B98L3927AU
NH5535U	NHD5535U	NHP5535U	B2241557	B84303958	—	B98L3958AU
Price	<b>4,100JPY</b> /piece	<b>18,200JPY</b> /piece	<b>3,200JPY</b> /piece	<b>6,600JPY</b> /piece	<b>13,100JPY</b> /box	<b>13,600JPY</b> /box
Number of panel per package	10 pieces/box (Ordering Unit 1piece)	1piece	5 pieces/box	10 pieces/box <sup>*1</sup> (Ordering Unit 1piece) Caulking(400ml)10pieces, Primer,brush,nozzle2pieces <small>*Holder set are sold separately</small>	1 set/box Inorganic ever-drying type Paint Base(10g)2 kinds each, Hardener(7g)3pieces, Primer(7.5g)1piece, brush3pieces	1 set/box Inorganic ever-drying type Paint Base(10g)3 kinds each, Hardener(7g)3pieces, Primer(7.5g)1piece, brush4pieces

\*1 The dedicated primer (part number B85AA or B85BB) will be shipped at the same time.

# Edel Wood

<b>Coating performance</b>	<b>Weather resistance</b>	<b>Installation</b>
Photocatalytic Self-cleaning	Weather resistance grade ★★	Installation Horizontal and Vertical



NH5872U



NH5873U



NH5874U

## Specifications

Size	18×455(exposed width)×3030mm
Price	<b>9,500JPY</b> /piece 6,890JPY/m <sup>2</sup>
Number of panel per package	2pieces
Coverage	1.38m <sup>2</sup> /piece
Weight	Approx. 23kg/piece

## Outside corner

Outside corner l=455      Outside corner l=3030      Shiplap corner

Vertical installation with clips

18×outside:93(inside:75) ×455(exposed width)      18×outside:93(inside:75) ×3030

## Accessories list

Genuine accessories are required to install siding panels

Panel	Outside corner l=455	Outside corner l=3030	Through Wall Flashing l=3030	Caulking (Holder set: B80E)	Repair Paint
NH5872U	NHD5872U	NHP5872U	B22412606	B84304080	B97L4080AU
NH5873U	NHD5873U	NHP5873U	B22412606	B84304081	B97L4081AU
NH5874U	NHD5874U	NHP5874U	B22413060	B84304082	B97L4082AU
Price	<b>4,100JPY</b> /piece	<b>18,200JPY</b> /piece	<b>3,200JPY</b> /piece	<b>6,600JPY</b> /piece	<b>13,100JPY</b> /box
Number of panel per package	10 pieces/box (Ordering Unit 1piece)	1piece	5 pieces/box	10 pieces/box <sup>*1</sup> (Ordering Unit 1piece) Caulking(400ml)10pieces, Primer,brush,nozzle2pieces <small>*Holder set are sold separately</small>	1 set/box Inorganic ever-drying type Paint Base(10g)2 kinds each, Hardener(7g)2pieces, Primer(7.5g)1piece,brush3pieces

\*1 The dedicated primer (part number B85AA or B85BB) will be shipped at the same time.

# Sephiro Wood 18

Coating performance	Weather resistance	Installation
Photocatalytic Self-cleaning	Weather resistance grade ★★★	Installation Horizontal and Vertical



NH5475U



NH5476U



NH5477U



NH5478U



NH5479U



NH54710U



NH54711U



NH54712U

## Specifications

Size	18×455(exposed width)×3030mm
Price	<b>9,500JPY/piece</b> 6,890JPY/m <sup>2</sup>
Number of panel per package	2pieces
Coverage	1.38m <sup>2</sup> /piece
Weight	Approx. 22kg/piece

## Outside corner

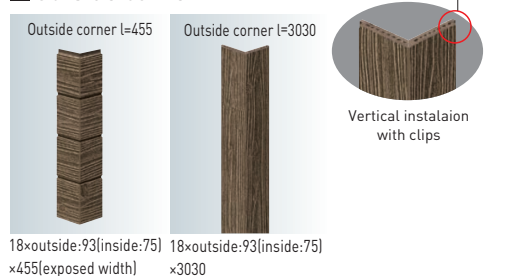

## Accessories list

Genuine accessories are required to install siding panels

Panel	Outside corner l=455	Outside corner l=3030	Through Wall Flashing l=3030	Caulking (Holder set: B80E)	Repair Paint
NH5475U	NHD5475U	NHP5475U	B2241476	B84302833	B972833CU
NH5476U	NHD5476U	NHP5476U	B22413114	B84302834A	B972834CU
NH5477U	NHD5477U	NHP5477U	B2241549	B84302835	B972835CU
NH5478U	NHD5478U	NHP5478U	B2241W3	B84302836	B972836CU
NH5479U	NHD5479U	NHP5479U	B22412606	B84302920	B972920AU
NH54710U	NHD54710U	NHP54710U	B2241W2	B8430495	B973946AU
NH54711U	NHD54711U	NHP54711U	B2241417	B84304040	B973947AU
NH54712U	NHD54712U	NHP54712U	B2241W1	B8430709	B972931BU
Price	<b>4,100JPY/piece</b>	<b>18,200JPY/piece</b>	<b>3,200JPY/piece</b>	<b>6,600JPY/piece</b>	<b>13,100JPY/box</b>
Number of panel per package	10 pieces/box (Ordering Unit 1piece)	1piece	5 pieces/box	10 pieces/box <sup>*1</sup> (Ordering Unit 1piece) Caulking(400ml)10pieces, Primer,brush,nozzle2pieces *Holder set are sold separately	1 set/box Inorganic over-drying type Paint Base(9g)2 kinds each, Hardener(7g)2pieces, Primer(7.5g)1piece,brush3pieces

\*1 The dedicated primer (part number B85AA or B85BB) will be shipped at the same time.

# Mesh Line

<b>Coating performance</b>	<b>Weather resistance</b>	<b>Installation</b>
Photocatalytic Self-cleaning	Weather resistance grade ★★	Installation Horizontal and Vertical



NH5891U



NH5892U



NH5893U



NH5894U

## Specifications

Size	18×455(exposed width)×3030mm
Price	<b>9,500JPY</b> /piece 6,890JPY/m <sup>2</sup>
Number of panel per package	2pieces
Coverage	1.38m <sup>2</sup> /piece
Weight	Approx. 23kg/piece

## Outside corner

Outside corner l=455

18×outside:93(inside:75)  
×455(exposed width)

## Accessories list

Genuine accessories are required to install siding panels

Panel	Accessories	Outside corner l=455	Through Wall Flashing l=3030	Caulking (Holder set: B80E)	Repair Paint
NH5891U		NHD5891U	B2241557	B84301807	B96L3104CU
NH5892U		NHD5892U	B2241417	B8430976B	B96L3003AU
NH5893U		NHD5893U	B2241W1	B84302632	B96L2416BU
NH5894U		NHD5894U	B22412606	B84303272	B96L3218AU
Price		<b>4,100JPY</b> /piece	<b>3,200JPY</b> /piece	<b>6,600JPY</b> /piece	<b>6,600JPY</b> /box
Number of panel per package		10 pieces/box (Ordering Unit 1piece)	5 pieces/box	10 pieces/box <sup>*1</sup> (Ordering Unit 1piece) Caulking(600ml)10pieces, Primer,brush,nozzle2pieces <small>*Holder set are sold separately</small>	1 set/box Inorganic ever-drying type Paint Base(10g)1piece, Hardener(7g)1piece, Primer(7.5g)1piece,brush2pieces

\*1 The dedicated primer (part number B85AA or B85BB) will be shipped at the same time.

# Eclath

Coating performance	Weather resistance	Installation
Photocatalytic Self-cleaning	Weather resistance grade ★★★	Installation Horizontal



NH5401A



NH5402A



NH5404A

## Specifications

Size	18×455(exposed width)×3030mm
Price	<b>9,200JPY</b> /piece 6,670JPY/m <sup>2</sup>
Number of panel per package	2pieces
Coverage	1.38m <sup>2</sup> /piece
Weight	Approx. 22kg/piece

## Outside corner



## Accessories list

Genuine accessories are required to install siding panels

Panel	Accessories	Outside corner l=455	Caulking (Holder set: B80E)	Repair Paint
NH5401A		NHD5401A	B84303051	B96L3051CA
NH5402A		NHD5402A	B84302491C	B96L2531EA
NH5404A		NHD5404A	B8430713B	B96L2416BA
Price		<b>4,100JPY</b> /piece	<b>6,600JPY</b> /piece	<b>6,600JPY</b> /box
Number of panel per package		10 pieces/box (Ordering Unit 1piece)	10 pieces/box <sup>*1</sup> (Ordering Unit 1piece) Caulking(600ml)10pieces, Primer,brush,nozzle2pieces <small>*Holder set are sold separately</small>	1 set/box Inorganic ever-drying type Paint Base(10g)1piece, Hardener(7g)1piece, Primer(7.5g)1piece,brush2pieces

\*1 The dedicated primer (part number B85AA or B85BB) will be shipped at the same time.

## Neorock Photocatalytic Ceramic Coating 18

# Resti

Coating performance	Weather resistance	Installation
Photocatalytic Self-cleaning	Weather resistance grade ★★★	Installation Horizontal



NH5231U



NH5232U



NH5234U



NH5235U

### Specifications

Size	18×455(exposed width)×3030mm
Price	<b>9,200JPY</b> /piece 6,670JPY/m <sup>2</sup>
Number of panel per package	2pieces
Coverage	1.38m <sup>2</sup> /piece
Weight	Approx. 23kg/piece

### Outside corner



### Accessories list

Genuine accessories are required to install siding panels

Panel	Accessories	Outside corner l=455	Caulking (Holder set: B80E)	Repair Paint
NH5231U		NHD5231U	B8430495	B96L1438DU
NH5232U		NHD5232U	B8430746	B96L1439BU
NH5234U		NHD5234U	B84303051	B96L3106BU
NH5235U		NHD5235U	B84302767	B96L2767AU
Price		<b>4,100JPY</b> /piece	<b>6,600JPY</b> /piece	<b>6,600JPY</b> /box
Number of panel per package		10 pieces/box (Ordering Unit 1piece)	10 pieces/box <sup>*1</sup> (Ordering Unit 1piece) Caulking(600ml)10pieces, Primer,brush,nozzle2pieces <small>*Holder set are sold separately</small>	1 set/box Inorganic ever-drying type, Paint Base(10g)1piece, Hardener(7g)1piece, Primer(7.5g)1piece,brush2pieces

<sup>\*1</sup> The dedicated primer (part number B85AA or B85BB) will be shipped at the same time.

# Round Wave

<b>Coating performance</b>	<b>Weather resistance</b>	<b>Installation</b>
Photocatalytic Self-cleaning	Weather resistance grade ★★ ★	Installation Horizontal and Vertical



NH5125K



NH5126K



NH5127K



NH5128K

## Specifications

Size	18×455(exposed width)×3030mm
Price	<b>9,200JPY</b> /piece 6,670JPY/m <sup>2</sup>
Number of panel per package	2pieces
Coverage	1.38m <sup>2</sup> /piece
Weight	Approx. 22kg/piece

## Outside corner

Shiplap corner

Vertical installation with clips

18×outside:93(inside:75) ×455(exposed width)    18×outside:93(inside:75) ×3030

## Accessories list

Genuine accessories are required to install siding panels

Panel	Outside corner l=455	Outside corner l=3030	Through Wall Flashing l=3030	Caulking (Holder set: B80E)	Repair Paint
NH5125K	NHD5125K	NHP5125K	B2241W2	B84302491C	B96L3160AK
NH5126K	NHD5126K	NHP5126K	B2241550	B84302503	B96L3165BK
NH5127K	NHD5127K	NHP5127K	B2241W3	B8430713	B96L3152AK
NH5128K	NHD5128K	NHP5128K	B2241578	B84303003A	B96L3168AK
Price	<b>4,100JPY</b> /piece	<b>18,200JPY</b> /piece	<b>3,200JPY</b> /piece	<b>6,600JPY</b> /piece	<b>6,600JPY</b> /box
Number of panel per package	10 pieces/box (Ordering Unit 1piece)	1piece	5 pieces/box	10 pieces/box*1 (Ordering Unit 1piece) Caulking(600ml)10pieces, Primer,brush,nozzle2pieces *Holder set are sold separately	1 set/box Inorganic ever-drying type Paint Base(10g)1piece, Hardener(7g)1piece, Primer(7.5g)1piece,brush2pieces

\*1 The dedicated primer (part number B85AA or B85BB) will be shipped at the same time.

# Imperial

Coating performance	Weather resistance	Installation
Photocatalytic Self-cleaning	Weather resistance grade ★★★	Installation Horizontal



**E** NH5721U  
**F** NH5721K



**E** NH5722U  
**F** NH5722K



**E** NH5723U  
**F** NH5723K



**E** NH5724U  
**F** NH5724K



**E** NH5725U  
**F** NH5725K



**E** NH5726U  
**F** NH5726K



**E** NH5727U  
**F** NH5727K

## Specifications

Size	18×455(exposed width)×3030mm
Price	<b>9,200JPY/piece</b> 6,670JPY/m <sup>2</sup>
Number of panel per package	2pieces
Coverage	1.38m <sup>2</sup> /piece
Weight	Approx. 23kg/piece

## Outside corner



## Accessories list

Genuine accessories are required to install siding panels

Panel	Accessories	Outside corner l=455	Caulking (Holder set: B80E)	Repair Paint
E	NH5721U	NHD5721U	B84303051	B96L3106AU
	NH5722U	NHD5722U	B84302491C	B96L3104AU
	NH5723U	NHD5723U	B8430557	B96L2546BU
	NH5724U	NHD5724U	B84301823	B96L3211AU
	NH5725U	NHD5725U	B84301758A	B96L2583BU
	NH5726U	NHD5726U	B8430713	B96L2416BU
	NH5727U	NHD5727U	B84303045	B96L3222AU
F	NH5721K	NHD5721K	B84303051	B96L3167AK
	NH5722K	NHD5722K	B84302491C	B96L3160AK
	NH5723K	NHD5723K	B8430557	B96L3156CK
	NH5724K	NHD5724K	B84301823	B96L3211AU
	NH5725K	NHD5725K	B84301758A	B96L3166AK
	NH5726K	NHD5726K	B8430713	B96L3152AK
	NH5727K	NHD5727K	B84303045	B96L3224AK
Price		<b>4,100JPY/piece</b>	<b>6,600JPY/piece</b>	<b>6,600JPY/box</b>
Number of panel per package	10 pieces/box (Ordering Unit 1piece)	10 pieces/box <sup>*1</sup> (Ordering Unit 1piece)		1 set/box
		Caulking(600ml)10pieces, Primer,brush,nozzle2pieces		Inorganic ever-drying type Paint Base(10g)1piece,Hardener(7g)1piece, Primer(7.5g)1piece,brush2pieces
		*Holder set are sold separately		

\*1 The dedicated primer (part number B85AA or B85BB) will be shipped at the same time.

# Sho Sugi Ban

<b>Coating performance</b>	<b>Weather resistance</b>	<b>Installation</b>
Photocatalytic Self-cleaning	Weather resistance grade ★★ ★	Installation Horizontal and Vertical



NH5481U



NH5491U

## Specifications

Size	18×455(exposed width)×3030mm
Price	<b>9,200JPY</b> /piece 6,670JPY/m <sup>2</sup>
Number of panel per package	2pieces
Coverage	1.38m <sup>2</sup> /piece
Weight	Approx. 24kg/piece

## Outside corner

Outside corner l=455      Outside corner l=3030

Shiplap corner  
Vertical installation with clips

18×outside:93(inside:75) ×455(exposed width)      18×outside:93(inside:75) ×3030

## Accessories list

Genuine accessories are required to install siding panels

Panel	Outside corner l=455	Outside corner l=3030	Through Wall Flashing l=3030	Caulking (Holder set: B80E)	Repair Paint
NH5481U	NHD5481U	NHP5481U	B2241W1	B84303045	B96L3222AU
NH5491U	NHD5491U	NHP5491U	B2241W1	B84303045	B96L3222AU
Price	<b>4,100JPY</b> /piece	<b>18,200JPY</b> /piece	<b>3,200JPY</b> /piece	<b>6,600JPY</b> /piece	<b>6,600JPY</b> /box
Number of panel per package	10 pieces/box (Ordering Unit 1piece)	1piece	5 pieces/box	10 pieces/box*1 (Ordering Unit 1piece) Caulking(600ml)10pieces, Primer,brush,nozzle2pieces *Holder set are sold separately	1 set/box Inorganic ever-drying type Paint Base(10g)1piece, Hardener(7g)1piece, Primer(7.5g)1piece, brush2pieces

\*1 The dedicated primer (part number B85AA or B85BB) will be shipped at the same time.

# Carnac 18

Coating performance Photocatalytic Self-cleaning	Weather resistance Weather resistance grade ★★★	Installation Installation Horizontal
---	--	---



**G** NH5501A  
**H** NH5501U  
**F** NH5501K



**G** NH5502A  
**H** NH5502U  
**F** NH5502K



**G** NH5503A  
**H** NH5503U  
**F** NH5503K



**G** NH5504A  
**H** NH5504U  
**F** NH5504K



**G** NH5505A  
**H** NH5505U  
**F** NH5505K

## Specifications

Size	18×455(exposed width)×3030mm
Price	<b>9,200JPY/piece</b> 6,670JPY/m <sup>2</sup>
Number of panel per package	2pieces
Coverage	1.38m <sup>2</sup> /piece
Weight	Approx. 23kg/piece

## Outside corner



## Accessories list

Genuine accessories are required to install siding panels

Panel	Accessories	Outside corner L=455	Caulking (Holder set: B80E)	Repair Paint
<b>G</b>	NH5501A	NHD5501A	B84302491C	B96L2531EA
	NH5502A	NHD5502A	B84301615	B96L3209AA
	NH5503A	NHD5503A	B84303051	B96L3051CA
	NH5504A	NHD5504A	B84301758A	B96L2583BA
	NH5505A	NHD5505A	B84303045	B96L3222AA
<b>H</b>	NH5501U	NHD5501U	B84302491C	B96L2531EA
	NH5502U	NHD5502U	B84301615	B96L3177AK
	NH5503U	NHD5503U	B84303051	B96L3051CA
	NH5504U	NHD5504U	B84301758A	B96L2583BU
	NH5505U	NHD5505U	B84303045	B96L3224AK
<b>F</b>	NH5501K	NHD5501K	B84302491C	B96L3160AK
	NH5502K	NHD5502K	B84301615	B96L3177AK
	NH5503K	NHD5503K	B84303051	B96L3167AK
	NH5504K	NHD5504K	B84301758A	B96L3166AK
	NH5505K	NHD5505K	B84303045	B96L3224BK
Price		<b>4,100JPY/piece</b>	<b>6,600JPY/piece</b>	<b>6,600JPY/box</b>
Number of panel per package	10 pieces/box (Ordering Unit 1piece)	10 pieces/box <sup>*1</sup> (Ordering Unit 1piece)		1 set/box
		Caulking(600ml)10pieces, Primer,brush,nozzle2pieces <small>*1 Holder set are sold separately</small>		Inorganic ever-drying type Paint Base(10g)1piece,Hardener(7g)1piece, Primer(7.5g)1piece,brush2pieces

\*1 The dedicated primer (part number B85AA or B85BB) will be shipped at the same time.

# Simple Stripe 18

Coating performance	Weather resistance	Installation
Photocatalytic Self-cleaning	Weather resistance grade ★★★	Installation Horizontal and Vertical



**E** NH5881U  
**F** NH5881K



**E** NH5882U  
**F** NH5882K



**E** NH5883U  
**F** NH5883K



**E** NH5884U  
**F** NH5884K



**E** NH5885U  
**F** NH5885K



**E** NH5886U  
**F** NH5886K



**E** NH5887U  
**F** NH5887K



**E** NH5888U  
**F** NH5888K

## Specifications

Size	18×455(exposed width)×3030mm
Price	<b>9,200JPY/piece</b> 6,670JPY/m <sup>2</sup>
Number of panel per package	2pieces
Coverage	1.38m <sup>2</sup> /piece
Weight	Approx. 23kg/piece

## Outside corner

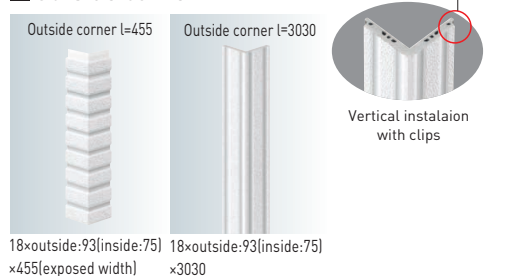

## Accessories list

Genuine accessories are required to install siding panels

Panel	Accessories	Outside corner l=455	Outside corner l=3030	Through Wall Flashing l=3030	Caulking (Holder set: B80E)	Repair Paint
E	NH5881U	NHD5881U	NHP5881U	B22413058	B84303051	B96L3106AU
	NH5882U	NHD5882U	NHP5882U	B2241W2	B84302491C	B96L3104AU
	NH5883U	NHD5883U	NHP5883U	B2241549	B84303212	B96L3212AU
	NH5884U	NHD5884U	NHP5884U	B2241549	B84303219	B96L3219AU
	NH5885U	NHD5885U	NHP5885U	B2241462	B84301758A	B96L2583BU
	NH5886U	NHD5886U	NHP5886U	B2241W3	B8430713B	B96L2416BU
	NH5887U	NHD5887U	NHP5887U	B2241W1	B84303045	B96L3222AU
	NH5888U	NHD5888U	NHP5888U	B2241468	B84303431A	B96L3431AU
F	NH5881K	NHD5881K	NHP5881K	B22413058	B84303051	B96L3167AK
	NH5882K	NHD5882K	NHP5882K	B2241W2	B84302491C	B96L3160AK
	NH5883K	NHD5883K	NHP5883K	B2241549	B84303212	B96L3212AU
	NH5884K	NHD5884K	NHP5884K	B2241549	B84303219	B96L3219AU
	NH5885K	NHD5885K	NHP5885K	B2241462	B84301758A	B96L3166AK
	NH5886K	NHD5886K	NHP5886K	B2241W3	B8430713B	B96L3152AK
	NH5887K	NHD5887K	NHP5887K	B2241W1	B84303045	B96L3224AK
	NH5888K	NHD5888K	NHP5888K	B2241468	B84303431	B96L3431AU
Price	<b>4,100JPY/piece</b>	<b>18,200JPY/piece</b>	<b>3,200JPY/piece</b>	<b>6,600JPY/piece</b>	<b>6,600JPY/box</b>	
Number of panel per package	10 pieces/box (Ordering Unit 1piece)	1piece	5 pieces/box	10 pieces/box <sup>*</sup> (Ordering Unit 1piece) Caulking(600ml)10pieces, Primer,brush,nozzle2pieces <sup>*</sup> Holder set are sold separately	1 set/box Inorganic ever-drying type Paint Base(10g)1piece, Hardener(7g)1piece, Primer(7.5g)1piece,brush2pieces	

\*1 The dedicated primer (part number B85AA or B85BB) will be shipped at the same time.

# Modern Slit 18

<b>Coating performance</b>	<b>Weather resistance</b>	<b>Installation</b>
Photocatalytic Self-cleaning	Weather resistance grade ★★ ★	Installation Horizontal and Vertical



NH5441K



NH5445K



NH5447K



NH5449K



NH54410K

## Specifications

Size	18×455(exposed width)×3030mm
Price	<b>9,200JPY</b> /piece 6,670JPY/m <sup>2</sup>
Number of panel per package	2pieces
Coverage	1.38m <sup>2</sup> /piece
Weight	Approx. 23kg/piece

## Outside corner

Shiplap corner

Vertical installation with clips

18×outside:93(inside:75)×455(exposed width)

18×outside:93(inside:75)×3030

## Accessories list

Genuine accessories are required to install siding panels

Panel	Accessories	Outside corner l=455	Outside corner l=3030	Through Wall Flashing l=3030	Caulking (Holder set: B80E)	Repair Paint
NH5441K		NHD5441K	NHP5441K	B2241W2	B84302491C	B96L3160AK
NH5445K		NHD5445K	NHP5445K	B2241462	B84301758A	B96L3166AK
NH5447K		NHD5447K	NHP5447K	B2241550	B84302503	B96L3165AK
NH5449K		NHD5449K	NHP5449K	B22413060	B8430708	B96L3235AK
NH54410K		NHD54410K	NHP54410K	B2241W3	B8430713B	B96L3152AK
Price		<b>4,100JPY</b> /piece	<b>18,200JPY</b> /piece	<b>3,200JPY</b> /piece	<b>6,600JPY</b> /piece	<b>6,600JPY</b> /box
Number of panel per package		10 pieces/box (Ordering Unit 1piece)	1piece	5 pieces/box	10 pieces/box <sup>1)</sup> (Ordering Unit 1piece) Caulking[600ml]10pieces, Primer,brush,nozzle2pieces	1 set/box Inorganic ever-drying type Paint Base[10g]1piece, Hardener[7g]1piece, Primer[7.5g]1piece,brush2pieces

<sup>1)</sup> The dedicated primer (part number B85AA or B85BB) will be shipped at the same time.

# Cantabile

<b>Coating performance</b> Photocatalytic Self-cleaning	<b>Weather resistance</b> Weather resistance grade ★★★	<b>Installation</b> Installation Horizontal and Vertical
--	---	---



NH5921A



NH5922A



NH5923A



NH5924A

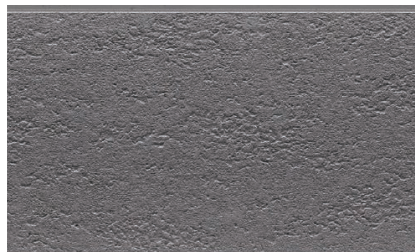

NH5925A

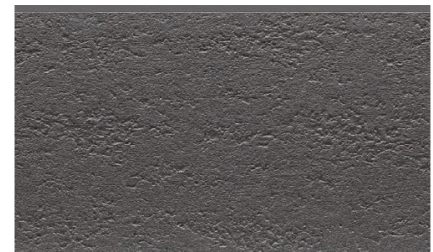

NH5926A

## Specifications

Size	18×455(exposed width)×3030mm
Price	<b>9,200JPY</b> /piece 6,670JPY/m <sup>2</sup>
Number of panel per package	2pieces
Coverage	1.38m <sup>2</sup> /piece
Weight	Approx. 24kg/piece

## Outside corner

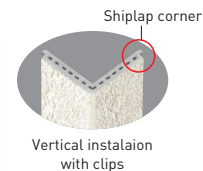

## Accessories list

Genuine accessories are required to install siding panels

Panel	Outside corner l=455	Outside corner l=3030	Through Wall Flashing l=3030	Caulking (Holder set: B80E)	Repair Paint
NH5921A	NHD5921A	NHP5921A	B2241W2	B84302491C	B96L2531EA
NH5922A	NHD5922A	NHP5922A	B2241417	B84302690A	B96L2690CA
NH5923A	NHD5923A	NHP5923A	B2241550	B84302503	B96L2525DA
NH5924A	NHD5924A	NHP5924A	B2241550	B84301823	B96L3211AA
NH5925A	NHD5925A	NHP5925A	B2241549	B84303212	B96L3212AU
NH5926A	NHD5926A	NHP5926A	B2241549	B84302632	B96L2632HU
Price	<b>4,100JPY</b> /piece	<b>18,200JPY</b> /piece	<b>3,200JPY</b> /piece	<b>6,600JPY</b> /piece	<b>6,600JPY</b> /box
Number of panel per package	10 pieces/box (Ordering Unit 1piece)	1piece	5 pieces/box	10 pieces/box*1 (Ordering Unit 1piece) Caulking(600ml)10pieces, Primer,brush,nozzle2pieces *Holder set are sold separately	1 set/box Inorganic ever-drying type Paint Base(10g)1piece, Hardener(7g)1piece, Primer(7.5g)1piece,brush2pieces

\*1 The dedicated primer (part number B85AA or B85BB) will be shipped at the same time.

# Knitty 18

Coating performance	Weather resistance	Installation
Photocatalytic Self-cleaning	Weather resistance grade ★★★	Installation Horizontal and Vertical



NH5621K



NH5622K



NH5624K

## Specifications

Size	18×455(exposed width)×3030mm
Price	<b>9,200JPY</b> /piece 6,670JPY/m <sup>2</sup>
Number of panel per package	2pieces
Coverage	1.38m <sup>2</sup> /piece
Weight	Approx. 23kg/piece

## Outside corner

Outside corner l=455      Outside corner l=3030      Shiplap corner

Vertical installation with clips

18×outside:93(inside:75) ×455(exposed width)      18×outside:93(inside:75) ×3030

## Accessories list

Genuine accessories are required to install siding panels

Panel	Outside corner l=455	Outside corner l=3030	Through Wall Flashing l=3030	Caulking (Holder set: B80E)	Repair Paint
NH5621K	NHD5621K	NHP5621K	B2241W2	B84302491	B96L3160AK
NH5622K	NHD5622K	NHP5622K	B2241512	B8430746	B96L3148AK
NH5624K	NHD5624K	NHP5624K	B2241550	B84301843	B96L2533AU
Price	<b>4,100JPY</b> /piece	<b>18,200JPY</b> /piece	<b>3,200JPY</b> /piece	<b>6,600JPY</b> /piece	<b>6,600JPY</b> /box
Number of panel per package	10 pieces/box (Ordering Unit 1piece)	1piece	5 pieces/box	10 pieces/box*1 (Ordering Unit 1piece) Caulking(600ml)10pieces, Primer,brush,nozzle2pieces *Holder set are sold separately	1 set/box Inorganic ever-drying type Paint Base(10g)1piece, Hardener(7g)1piece, Primer(7.5g)1piece,brush2pieces

\*1 The dedicated primer (part number B85AA or B85BB) will be shipped at the same time.



# Strahl 18

Coating performance	Weather resistance	Installation
Photocatalytic Self-cleaning	Weather resistance grade ★★★	Installation Horizontal



G NH5791A  
H NH5791U  
F NH5791K



G NH5792A  
H NH5792U  
F NH5792K



G NH5793A  
H NH5793U  
F NH5793K



G NH5794A  
H NH5794U  
F NH5794K



G NH5796A  
H NH5796U  
F NH5796K



G NH5797A  
H NH5797U  
F NH5797K



G NH5798A  
H NH5798U  
F NH5798K



G NH5799A  
H NH5799U  
F NH5799K



G NH57910A  
H NH57910U  
F NH57910K



G NH57911A  
H NH57911U  
F NH57911K

## Specifications

Size	18×455(exposed width)×3030mm
Price	<b>9,200JPY/piece</b> 6,670JPY/m <sup>2</sup>
Number of panel per package	2pieces
Coverage	1.38m <sup>2</sup> /piece
Weight	Approx. 23kg/piece

## Outside corner



## Accessories list

Genuine accessories are required to install siding panels

Panel	Accessories	Outside corner l=455	Caulking (Holder set: B80E)	Repair Paint
G	NH5791A	NHD5791A	B84302491C	B96L2531EA
	NH5792A	NHD5792A	B8430495	B96L1438CA
	NH5793A	NHD5793A	B8430746	B96L1439CA
	NH5794A	NHD5794A	B84302503	B96L2525CA
	NH5796A	NHD5796A	B84301758A	B96L2583BA
	NH5797A	NHD5797A	B84303051	B96L3051CA
	NH5798A	NHD5798A	B84303003A	B96L3003AA
	NH5799A	NHD5799A	B84302715	B96L2715CA
	NH57910A	NHD57910A	B8430582	B96L2528CA
	NH57911A	NHD57911A	B84303215	B96L3222AA
H	NH5791U	NHD5791U	B84302491C	B96L3104AU
	NH5792U	NHD5792U	B8430495A	B96L1438DU
	NH5793U	NHD5793U	B8430746	B96L1439BU
	NH5794U	NHD5794U	B84301823	B96L3165AK
	NH5796U	NHD5796U	B84301758A	B96L2583BU
	NH5797U	NHD5797U	B84303051	B96L3106AU
	NH5798U	NHD5798U	B84303003A	B96L3168AK
	NH5799U	NHD5799U	B84302715	B96L2715CA
	NH57910U	NHD57910U	B8430582	B96L3150AK
	NH57911U	NHD57911U	B84303215	B96L3224AK
F	NH5791K	NHD5791K	B84302491C	B96L3160AK
	NH5792K	NHD5792K	B8430495	B96L3143AK
	NH5793K	NHD5793K	B8430746	B96L3148AK
	NH5794K	NHD5794K	B84302503	B96L3165AK
	NH5796K	NHD5796K	B84301758A	B96L3166AK
	NH5797K	NHD5797K	B84303051	B96L3167AK
	NH5798K	NHD5798K	B84303003A	B96L3168AK
	NH5799K	NHD5799K	B84302715	B96L3169AK
	NH57910K	NHD57910K	B8430582	B96L3150AK
	NH57911K	NHD57911K	B84303215	B96L3224AK
Price		<b>4,100JPY/piece</b>	<b>6,600JPY/piece</b>	<b>6,600JPY/box</b>
Number of panel per package	10 pieces/box (Ordering Unit 1piece)	10 pieces/box <sup>*1</sup> (Ordering Unit 1piece)		1 set/box
		Caulking(600ml)10pieces, Primer,brush,nozzle2pieces <small>*1Holder set are sold separately</small>		Inorganic ever-drying type Paint Base(10g)1piece,Hardener(7g)1piece, Primer(7.5g)1piece,brush2pieces

\*1 The dedicated primer (part number B85AA or B85BB) will be shipped at the same time.

# Fiotto 18

<b>Coating performance</b> Photocatalytic Self-cleaning	<b>Weather resistance</b> Weather resistance grade ★★	<b>Installation</b> Installation Horizontal and Vertical
--	--	---



**E** NH5631U  
**F** NH5631K



**E** NH5632U  
**F** NH5632K



**E** NH5633U  
**F** NH5633K



**E** NH5636U  
**F** NH5636K



**E** NH56313U  
**F** NH56313K



**E** NH56314U  
**F** NH56314K

## Specifications

Size	18×455(exposed width)×3030mm
Price	<b>9,200JPY</b> /piece 6,670JPY/m <sup>2</sup>
Number of panel per package	2pieces
Coverage	1.38m <sup>2</sup> /piece
Weight	Approx. 23kg/piece

## Outside corner

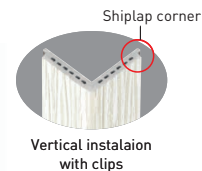
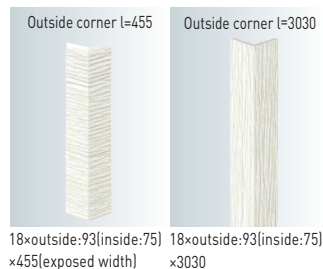

## Accessories list

Genuine accessories are required to install siding panels

Accessories		Outside corner l=455	Outside corner l=3030	Through Wall Flashing l=3030	Caulking (Holder set: B80E)	Repair Paint
<b>E</b>	NH5631U	NHD5631U	NHP5631U	B2241W2	B8430577	B96L2540CU
	NH5632U	NHD5632U	NHP5632U	B2241W2	B8430495	B96L1438DU
	NH5633U	NHD5633U	NHP5633U	B2241578	B84301616	B96L1622CU
	NH5636U	NHD5636U	NHP5636U	B2241W3	B8430713	B96L2416BU
	NH56313U	NHD56313U	NHP56313U	B2241417	B84302690A	B96L2712AU
	NH56314U	NHD56314U	NHP56314U	B22413114	B84303234	B96L3234AK
<b>F</b>	NH5631K	NHD5631K	NHP5631K	B2241W2	B8430577	B96L3170AK
	NH5632K	NHD5632K	NHP5632K	B2241W2	B8430495	B96L3143AK
	NH5633K	NHD5633K	NHP5633K	B2241578	B84301616	B96L3171AK
	NH5636K	NHD5636K	NHP5636K	B2241W3	B8430713	B96L3152AK
	NH56313K	NHD56313K	NHP56313K	B2241417	B84302690A	B96L3179AK
	NH56314K	NHD56314K	NHP56314K	B22413114	B84303234	B96L3234AK
Price		<b>4,100JPY</b> /piece	<b>18,200JPY</b> /piece	<b>3,200JPY</b> /piece	<b>6,600JPY</b> /piece	<b>6,600JPY</b> /box
Number of panel per package		10 pieces/box (Ordering Unit 1piece)	1piece	5 pieces/box	10 pieces/box <sup>*1</sup> (Ordering Unit 1piece) Caulking(600ml)10pieces, Primer,brush,nozzle2pieces <small>*Holder set are sold separately</small>	1 set/box <small>Inorganic ever-drying type Paint Base(10g)1piece,Hardener(7g)1piece, Primer(7.5g)1piece,brush2pieces</small>

\*1 The dedicated primer (part number B85AA or B85BB) will be shipped at the same time.





Excellage Photocatalytic Ceramic Coating 15  
Roche Stripe  
EH4833K

## Excellage Photocatalytic Ceramic Coating 15

### Excellage Photocatalytic Ceramic Coating 15

Bastia  
 Solennael  
 Silbus Tile 15  
 Fine Cresta 15  
 Roche Stripe  
 Traditional Border 15  
 Baker Brick  
 Stable Tile  
 Cube Sucre 15  
 Scratch Cross  
 Clair Wood 15  
 Cimant Flat  
 Plaster Flat 15  
 Smash Line 15  
 Placido 15

### Joint Alignment & Connection Sections

#### Joint Alignment with Caulking

- To enhance the natural appearance of the design, the joint width intentionally varies.

In addition, the joints on both sides of the caulking may be misaligned by approximately 3mm.

- The joint width varies to create a natural design expression.

- The joints on either side of the caulking may be offset by around 3mm.

#### Connection Sections

A joint is placed every approx. 455mm in the vertical direction.

Depending on lighting conditions, sunlight, or viewing angle, subtle shadows or slight gaps may appear along the joint lines.

### Performance List

item	unit	Excellage Photocatalytic Ceramic Coating 15	note
		15mm thickness	
specific gravity	—	1.1*	Drying at 105°C for 24 hours
Water content	%	20 or under	JISA5422
Water absorption rate	%	50 or under	Water absorption 24h→105°C 24h
Bending Failure Load	N	785 or over	JISA5422
Impact resistance	—	Passed	JISA5422

\*These are our measured values.

# Bastia

Coating performance	Weather resistance	Installation
Photocatalytic Self-cleaning	Weather resistance grade ★★	Installation Horizontal



EH7721H



EH7722H



EH7723H



EH7724H



EH7725H

## Specifications

Size	15×455(exposed width)×3030mm
Price	<b>8,900JPY</b> /piece 6,460JPY/m <sup>2</sup>
Number of panel per package	2pieces
Coverage	1.38m <sup>2</sup> /piece
Weight	Approx. 25kg/piece

## Outside corner



## Accessories list

Genuine accessories are required to install siding panels

Panel	Accessories	Outside corner l=455	Caulking (Holder set: B80E)	Repair Paint	
EH7721H		EHD7721H	B84304196	B96L3300AH	—
EH7722H		EHD7722H	B84304197	B96L2419AH	—
EH7723H		EHD7723H	B84303958	—	B97L3059AH
EH7724H		EHD7724H	B84304199	B96L3108AH	—
EH7725H		EHD7725H	B84304200	B96L3342AH	—
Price		<b>4,000JPY</b> /piece	<b>6,600JPY</b> /piece	<b>6,600JPY</b> /box	<b>13,100JPY</b> /box
Number of panel per package	10 pieces/box (Ordering Unit 1piece)		10 pieces/box*1 (Ordering Unit 1piece)	1 set/box	1 set/box
			Caulking(600ml)10pieces, Primer,brush,nozzle2pieces *Holder set are sold separately	Inorganic ever-drying type Paint Base(10g)1piece, Hardener(7g)1piece, Primer(7.5g)1piece,brush2pieces	Inorganic ever-drying type Paint Base(10g)2 kinds each, Hardener(7g)2pieces, Primer(7.5g)1piece,brush3pieces

\*1 The dedicated primer (part number B85AA or B85BB) will be shipped at the same time.

# Solennael

<b>Coating performance</b>	<b>Weather resistance</b>	<b>Installation</b>
Photocatalytic Self-cleaning	Weather resistance grade ★★	Installation Horizontal and Vertical



EH7081K



EH7082K



EH7083K



EH7084K

## Specifications

Size	15×455(exposed width)×3030mm
Price	<b>8,900JPY/piece</b> 6,460JPY/m <sup>2</sup>
Number of panel per package	2pieces
Coverage	1.38m <sup>2</sup> /piece
Weight	Approx. 24kg/piece

## Outside corner

Outside corner l=455



15×outside:90(inside:75) ×455(exposed width)

Outside corner l=3030



15×outside:90(inside:75) ×3030



Shiplap corner  
Vertical installation with clips

## Accessories list

Genuine accessories are required to install siding panels

Panel	Accessories		Through Wall Flashing l=3030	Caulking (Holder set: B80E)	Repair Paint	
	Outside corner l=455	Outside corner l=3030				
EH7081K	EHD7081K	EHP7081K	B2241W2	B84302491A	B96L1438DU	—
EH7082K	EHD7082K	EHP7082K	B2241512	B84302818	—	B97L3929AK
EH7083K	EHD7083K	EHP7083K	B2241550	B84302503	—	B97L3930AK
EH7084K	EHD7084K	EHP7084K	B2241W1	B8430709	B96L3931AK	—
Price	4,000JPY/piece	17,600JPY/piece	3,200JPY/piece	6,600JPY/piece	6,600JPY/box	13,100JPY/box
Number of panel per package	10 pieces/box (Ordering Unit 1piece)	1piece	5 pieces/box	10 pieces/box* (Ordering Unit 1piece) Caulking(600ml)10pieces, Primer,brush, nozzle2pieces *Holder set are sold separately	1 set/box Inorganic ever-drying type Paint Base(10g)1piece, Hardener(7g)1piece, Primer(7.5g)1piece,brush2pieces	1 set/box Inorganic ever-drying type Paint Base(10g)2 kinds each, Hardener(7g)2pieces, Primer(7.5g)1piece,brush3pieces

\*1 The dedicated primer (part number B85AA or B85BB) will be shipped at the same time.

# Silbus Tile 15

Coating performance Photocatalytic Self-cleaning	Weather resistance Weather resistance grade ★★★	Installation Installation Horizontal
---	---	--



EH37012K



EH37013K



EH37014K



EH37015K



EH37016K

## Specifications

Size	15×455(exposed width)×3030mm
Price	<b>8,900JPY</b> /piece 6,460JPY/m <sup>2</sup>
Number of panel per package	2pieces
Coverage	1.38m <sup>2</sup> /piece
Weight	Approx. 24kg/piece

## Outside corner

Outside corner l=455

15×outside:90(inside:75)  
×455(exposed width)

## Accessories list

Genuine accessories are required to install siding panels

Panel	Accessories	Outside corner l=455	Caulking (Holder set: B80E)	Repair Paint
EH37012K		EHD37012K	B84302491A	B97L3996AK
EH37013K		EHD37013K	B84304111	B97L3997AK
EH37014K		EHD37014K	B84304040	B97L3998AK
EH37015K		EHD37015K	B84302996	B97L3999AK
EH37016K		EHD37016K	B8430713	B97L4000AK
Price		<b>4,000JPY</b> /piece	<b>6,600JPY</b> /piece	<b>13,100JPY</b> /box
Number of panel per package		10 pieces/box (Ordering Unit 1piece)	10 pieces/box <sup>*1</sup> (Ordering Unit 1piece) Caulking(600ml)10pieces, Primer,brush,nozzle2pieces <small>*Holder set are sold separately</small>	1 set/box Inorganic ever-drying type Paint Base(10g)2 kinds each, Hardener(7g)2pieces, Primer(7.5g)1piece,brush3pieces

\*1 The dedicated primer (part number B85AA or B85BB) will be shipped at the same time.

# Fine Cresta 15

Coating performance	Weather resistance	Installation
Photocatalytic Self-cleaning	Weather resistance grade ★★	Installation Horizontal



EH3491K



EH3493K



EH3497K



EH3498K

## Specifications

Size	15×455(exposed width)×3030mm
Price	<b>8,900JPY</b> /piece 6,460JPY/m <sup>2</sup>
Number of panel per package	2pieces
Coverage	1.38m <sup>2</sup> /piece
Weight	Approx. 24kg/piece

## Outside corner



## Accessories list

Genuine accessories are required to install siding panels

Panel	Accessories	Outside corner l=455	Caulking (Holder set: B80E)	Repair Paint	
EH3491K		EHD3491K	B8430746	B96644DK	—
EH3493K		EHD3493K	B8430408	—	B97808BK
EH3497K		EHD3497K	B8430743	B96743CK	—
EH3498K		EHD3498K	B8430409	—	B971853BK
Price		<b>4,000JPY</b> /piece	<b>6,600JPY</b> /piece	<b>6,600JPY</b> /box	<b>13,100JPY</b> /box
Number of panel per package	10 pieces/box (Ordering Unit 1piece)	10 pieces/box <sup>*1</sup> (Ordering Unit 1piece)	1 set/box	1 set/box	
				Inorganic ever-drying type Paint Base(9g)1piece, Hardener(7g)1piece, Primer(7.5g)1piece,brush2pieces	
		*Holder set are sold separately		Inorganic ever-drying type Paint Base(9g)2 kinds each, Hardener(7g)2pieces, Primer(7.5g)1piece,brush3pieces	

\*1 The dedicated primer (part number B85AA or B85BB) will be shipped at the same time.

# Roche Stripe

Coating performance	Weather resistance	Installation
Photocatalytic Self-cleaning	Weather resistance grade ★★ ★	Installation Horizontal



EH4832K



EH4833K



EH4834K

## Specifications

Size	15×455(exposed width)×3030mm
Price	<b>8,900JPY</b> /piece 6,460JPY/m <sup>2</sup>
Number of panel per package	2pieces
Coverage	1.38m <sup>2</sup> /piece
Weight	Approx. 23kg/piece

## Outside corner

Outside corner l=455

15×outside:90(inside:75)  
×455(exposed width)

## Accessories list

Genuine accessories are required to install siding panels

Panel	Accessories	Outside corner l=455	Caulking (Holder set: B80E)	Repair Paint
EH4832K		EHD4832K	B84302818	B98L3831AK
EH4833K		EHD4833K	B84302417B	B98L3832AK
EH4834K		EHD4834K	B8430709	B98L3833AK
Price		<b>4,000JPY</b> /piece	<b>6,600JPY</b> /piece	<b>13,600JPY</b> /box
Number of panel per package		10 pieces/box (Ordering Unit 1piece)	10 pieces/box <sup>*1</sup> (Ordering Unit 1piece) Caulking(600ml)10pieces, Primer,brush,nozzle2pieces <small>*Holder set are sold separately</small>	1 set/box Inorganic ever-drying type Paint Base(10g)3 kinds each, Hardener(7g)3pieces, Primer(7.5g)1piece,brush4pieces

<sup>\*1</sup> The dedicated primer (part number B85AA or B85BB) will be shipped at the same time.

# Traditional Border 15

<b>Coating performance</b> Photocatalytic Self-cleaning	<b>Weather resistance</b> Weather resistance grade ★★	<b>Installation</b> Installation Horizontal and Vertical
--	--	---



EH3674K



EH3678K



EH3679K



EH36710K



EH36711K

## Specifications

Size	15×455(exposed width)×3030mm
Price	<b>8,900JPY</b> /piece 6,460JPY/m <sup>2</sup>
Number of panel per package	2pieces
Coverage	1.38m <sup>2</sup> /piece
Weight	Approx. 24kg/piece

## Outside corner

Outside corner l=455



15×outside:90(inside:75)×455(exposed width)

Outside corner l=3030



15×outside:90(inside:75)×3030

Shiplap corner



Vertical installation with clips

## Accessories list

Genuine accessories are required to install siding panels

Panel	Accessories		Through Wall Flashing l=3030	Caulking (Holder set: B80E)	Repair Paint	
	Outside corner l=455	Outside corner l=3030				
EH3674K	EHD3674K	EHP3674K	B2241W3	B8430743	B961468BK	—
EH3678K	EHD3678K	EHP3678K	B2241W3	B8430581	B961736BK	—
EH3679K	EHD3679K	EHP3679K	B2241512	B8430746	B96644EK	—
EH36710K	EHD36710K	EHP36710K	B2241W4	B84302503	—	B971916BK
EH36711K	EHD36711K	EHP36711K	B2241427	B8430498A	—	B971917AK
Price	<b>4,000JPY</b> /piece	<b>17,600JPY</b> /piece	<b>3,200JPY</b> /piece	<b>6,600JPY</b> /piece	<b>6,600JPY</b> /box	<b>13,100JPY</b> /box
Number of panel per package	10 pieces/box (Ordering Unit 1piece)	1piece	5 pieces/box	10 pieces/box*1 (Ordering Unit 1piece) Caulking(600ml)10pieces, Primer,brush,nozzle2pieces *Holder set are sold separately	1 set/box Inorganic ever-drying type Paint Base(9g)1piece, Hardener(7g)1piece, Primer(7.5g)1piece,brush2pieces	1 set/box Inorganic ever-drying type Paint Base(9g)2 kinds each, Hardener(7g)2pieces, Primer(7.5g)1piece,brush3pieces

\*1 The dedicated primer (part number B85AA or B85BB) will be shipped at the same time.

# Baker Brick

Coating performance	Weather resistance	Installation
Photocatalytic Self-cleaning	Weather resistance grade ★★★	Installation Horizontal



EH4276K



EH4278K



EH4279K

## Specifications

Size	15×455(exposed width)×3030mm
Price	<b>8,900JPY</b> /piece 6,460JPY/m <sup>2</sup>
Number of panel per package	2pieces
Coverage	1.38m <sup>2</sup> /piece
Weight	Approx. 24kg/piece

## Outside corner

Outside corner l=455

15×outside:90(inside:75)  
×455(exposed width)

## Accessories list

Genuine accessories are required to install siding panels

Panel	Accessories	Outside corner l=455	Caulking (Holder set: B80E)	Repair Paint
EH4276K		EHD4276K	B84303827	B97L4001AK
EH4278K		EHD4278K	B8430969	B97L4003AK
EH4279K		EHD4279K	B8430743	B97L4004AK
Price		<b>4,000JPY</b> /piece	<b>6,600JPY</b> /piece	<b>13,100JPY</b> /box
Number of panel per package		10 pieces/box (Ordering Unit 1piece)	10 pieces/box <sup>*1</sup> (Ordering Unit 1piece) Caulking(600ml)10pieces, Primer,brush,nozzle2pieces <small>*Holder set are sold separately</small>	1 set/box Inorganic ever-drying type Paint Base(10g)2 kinds each, Hardener(7g)2pieces, Primer(7.5g)1piece,brush3pieces

\*1 The dedicated primer (part number B85AA or B85BB) will be shipped at the same time.

# Stable Tile

Coating performance	Weather resistance	Installation
Photocatalytic Self-cleaning	Weather resistance grade ★★★	Installation Horizontal



EH4412K



EH4417K

## Specifications

Size	15×455(exposed width)×3030mm
Price	<b>8,900JPY</b> /piece 6,460JPY/m <sup>2</sup>
Number of panel per package	2pieces
Coverage	1.38m <sup>2</sup> /piece
Weight	Approx. 23kg/piece

## Outside corner



## Accessories list

Genuine accessories are required to install siding panels

Panel	Accessories	Outside corner l=455	Caulking (Holder set: B80E)	Repair Paint
EH4412K		EHD4412K	B84302818	B96L2899AK
EH4417K		EHD4417K	B84302491A	B96L2669AK
Price		<b>4,000JPY</b> /piece	<b>6,600JPY</b> /piece	<b>6,600JPY</b> /box
Number of panel per package		10 pieces/box (Ordering Unit 1piece)	10 pieces/box <sup>*1</sup> (Ordering Unit 1piece) Caulking(600ml)10pieces, Primer,brush,nozzle2pieces <small>*Holder set are sold separately</small>	1 set/box Inorganic ever-drying type Paint Base(10g)1piece, Hardener(7g)1piece, Primer(7.5g)1piece,brush2pieces

\*1 The dedicated primer (part number B85AA or B85BB) will be shipped at the same time.

# Cube Sucre 15

Coating performance	Weather resistance	Installation
Photocatalytic Self-cleaning	Weather resistance grade ★★★	Installation Horizontal



EH3946K

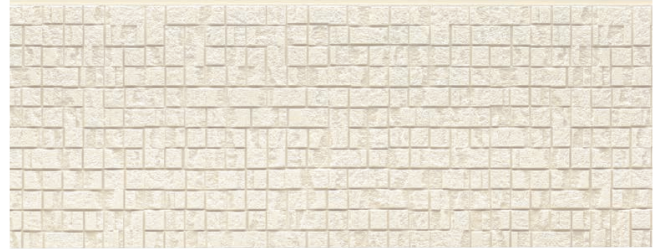

EH3947K

## Specifications

Size	15×455(exposed width)×3030mm
Price	<b>8,900JPY</b> /piece 6,460JPY/m <sup>2</sup>
Number of panel per package	2pieces
Coverage	1.38m <sup>2</sup> /piece
Weight	Approx. 24kg/piece

## Outside corner



## Accessories list

Genuine accessories are required to install siding panels

Panel	Accessories	Outside corner l=455	Caulking (Holder set: B80E)	Repair Paint
EH3946K		EHD3946K	B8430582	B961912CK
EH3947K		EHD3947K	B8430746	B961910BK
Price		<b>4,000JPY</b> /piece	<b>6,600JPY</b> /piece	<b>6,600JPY</b> /box
Number of panel per package		10 pieces/box (Ordering Unit 1piece)	10 pieces/box <sup>*1</sup> (Ordering Unit 1piece) Caulking(600ml)10pieces, Primer,brush, nozzle2pieces <small>*Holder set are sold separately</small>	1 set/box Inorganic ever-drying type Paint Base(9g)1piece, Hardener(7g)1piece, Primer(7.5g)1piece,brush2pieces

\*1 The dedicated primer (part number B85AA or B85BB) will be shipped at the same time.

# Scratch Cross

Coating performance	Weather resistance	Installation
Photocatalytic Self-cleaning	Weather resistance grade ★★★	Installation Horizontal



EH4041K



EH4044K

## Specifications

Size	15×455(exposed width)×3030mm
Price	<b>8,900JPY/piece</b> 6,460JPY/m <sup>2</sup>
Number of panel per package	2pieces
Coverage	1.38m <sup>2</sup> /piece
Weight	Approx. 24kg/piece

## Outside corner



## Accessories list

Genuine accessories are required to install siding panels

Panel	Accessories	Outside corner l=455	Caulking (Holder set: B80E)	Repair Paint	
EH4041K		EHD4041K	B84302491	B97L1891AK	—
EH4044K		EHD4044K	B8430709	—	B98L1894AK
Price		4,000JPY/piece	6,600JPY/piece	13,100JPY/box	13,600JPY/box
Number of panel per package		10 pieces/box (Ordering Unit 1piece)	10 pieces/box <sup>*1</sup> (Ordering Unit 1piece)	1 set/box	1 set/box
			Caulking(600ml)10pieces, Primer,brush,nozzle2pieces	Inorganic ever-drying type Paint Base(10g)2 kinds each, Hardener(7g)2pieces, Primer(7.5g)1piece,brush3pieces	Inorganic ever-drying type Paint Base(10g)3 kinds each, Hardener(7g)3pieces, Primer(7.5g)1piece,brush4pieces
			*Holder set are sold separately		

\*1 The dedicated primer (part number B85AA or B85BB) will be shipped at the same time.

# Clair Wood 15

Coating performance	Weather resistance	Installation
Photocatalytic Self-cleaning	Weather resistance grade ★★ ★	Installation Horizontal and Vertical



EH42310K



EH42311K



EH42312K



EH42313K



EH42314K



EH42315K



EH42316K

## Specifications

Size	15×455(exposed width)×3030mm
Price	<b>8,900JPY/piece</b> 6,460JPY/m <sup>2</sup>
Number of panel per package	2pieces
Coverage	1.38m <sup>2</sup> /piece
Weight	Approx. 24kg/piece

## Outside corner

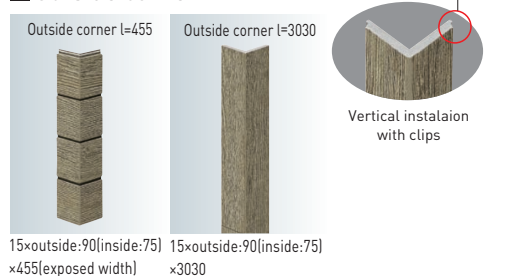

## Accessories list

Genuine accessories are required to install siding panels

Panel	Outside corner l=455	Outside corner l=3030	Through Wall Flashing l=3030	Caulking (Holder set: B80E)	Repair Paint
EH42310K	EHD42310K	EHP42310K	B2241W2	B8430495	B97L4005AK
EH42311K	EHD42311K	EHP42311K	B2241W4	B84301566C	B97L4006AK
EH42312K	EHD42312K	EHP42312K	B2241549	B84304007	B97L4007AK
EH42313K	EHD42313K	EHP42313K	B22412606	B84304008	B97L4008AK
EH42314K	EHD42314K	EHP42314K	B22413060	B84304009	B97L4009AK
EH42315K	EHD42315K	EHP42315K	B2241476	B8430748	B97L4010AK
EH42316K	EHD42316K	EHP42316K	B2241W3	B84302417B	B97L4011AK
Price	<b>4,000JPY/piece</b>	<b>17,600JPY/piece</b>	<b>3,200JPY/piece</b>	<b>6,600JPY/piece</b>	<b>13,100JPY/box</b>
Number of panel per package	10 pieces/box (Ordering Unit 1piece)	1piece	5 pieces/box	10 pieces/box <sup>*)</sup> (Ordering Unit 1piece) Caulking(600ml)10pieces, Primer,brush,nozzle2pieces <small>*Holder set are sold separately</small>	1 set/box Inorganic over-drying type Paint Base(10g)2 kinds each, Hardener(7g)2pieces, Primer(7.5g)1piece,brush3pieces

\*1 The dedicated primer (part number B85AA or B85BB) will be shipped at the same time.

# Cimant Flat

<b>Coating performance</b> Photocatalytic Self-cleaning	<b>Weather resistance</b> Weather resistance grade ★★★	<b>Installation</b> Installation Horizontal and Vertical
--	---	---



EH7301H



EH7302H



**A** EH7303H  
**B** EH7303K

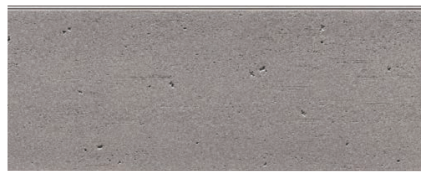

**A** EH7304H  
**B** EH7304K



EH7305H

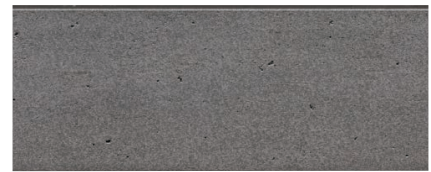

EH7306K

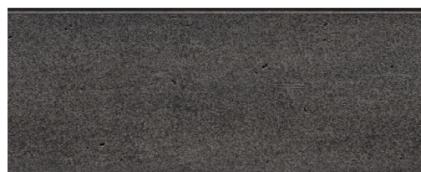

EH7307K

## Specifications

Size	15×455(exposed width)×3030mm
Price	<b>8,900JPY</b> /piece 6,460JPY/m <sup>2</sup>
Number of panel per package	2pieces
Coverage	1.38m <sup>2</sup> /piece
Weight	Approx. 25kg/piece

## Outside corner

Shiplap corner  
Vertical installation with clips

Outside corner l=455    Outside corner l=3030

15×outside:90(inside:75)×455(exposed width)    15×outside:90(inside:75)×3030

## Accessories list

Genuine accessories are required to install siding panels

Panel	Outside corner l=455	Outside corner l=3030	Through Wall Flashing l=3030	Caulking (Holder set: B80E)	Repair Paint
EH7301H	EHD7301H	EHP7301H	B2241W2	B84302491A	B96644EK
EH7302H	EHD7302H	EHP7302H	B2241557	B84303990	B963177AK
<b>A</b> EH7303H	EHD7303H	EHP7303H	B2241550	B84301937	B963327AH
<b>B</b> EH7303K	EHD7303K	EHP7303K	B2241550	B84301937	B963067AK
<b>A</b> EH7304H	EHD7304H	EHP7304H	B2241550	B84302414	B963326AH
<b>B</b> EH7304K	EHD7304K	EHP7304K	B2241550	B84302414	B963066AK
EH7305H	EHD7305H	EHP7305H	B2241549	B8430713	B96783BH
EH7306K	EHD7306K	EHP7306K	B2241549	B8430749B	B963290AK
EH7307K	EHD7307K	EHP7307K	B2241W3	B84303045	B963053AK
Price	<b>4,000JPY</b> /piece	<b>17,600JPY</b> /piece	<b>3,200JPY</b> /piece	<b>6,600JPY</b> /piece	<b>6,600JPY</b> /box
Number of panel per package	10 pieces/box (Ordering Unit 1piece)	1piece	5 pieces/box	10 pieces/box <sup>*)</sup> (Ordering Unit 1piece) Caulking[600ml]10pieces, Primer,brush,nozzle2pieces <small>*Holder set are sold separately</small>	1 set/box Inorganic ever-drying type Paint Base[9g]1piece, Hardener[7g]1piece, Primer[7.5g]1piece,brush2pieces

\*1 The dedicated primer (part number B85AA or B85BB) will be shipped at the same time.

# Plaster Flat 15

Coating performance	Weather resistance	Installation
Photocatalytic Self-cleaning	Weather resistance grade ★★★	Installation Horizontal



**A** EH7531H  
**B** EH7531K



**A** EH7532H  
**B** EH7532K



**A** EH7533H  
**B** EH7533K

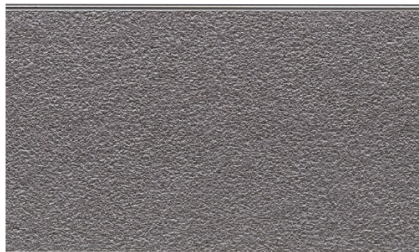

**A** EH7534H  
**B** EH7534K



**A** EH7535H  
**B** EH7535K



**A** EH7536H  
**B** EH7536K

## Specifications

Size	15×455(exposed width)×3030mm
Price	<b>8,900JPY</b> /piece 6,460JPY/m <sup>2</sup>
Number of panel per package	2pieces
Coverage	1.38m <sup>2</sup> /piece
Weight	Approx. 25kg/piece

## Outside corner

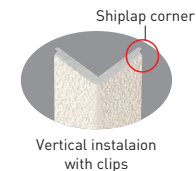
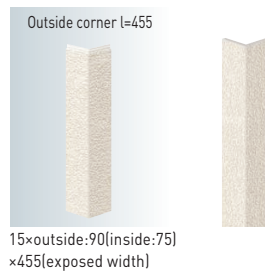

## Accessories list

Genuine accessories are required to install siding panels

Panel	Accessories	Outside corner l=455	Outside corner l=3030	Through Wall Flashing l=3030	Caulking (Holder set: B80E)	Repair Paint
<b>A</b>	EH7531H	EHD7531H	EHP7531H	B2241W2	B84302491A	B96L2597AH
	EH7532H	EHD7532H	EHP7532H	B2241417	B84302873	B96L3257AH
	EH7533H	EHD7533H	EHP7533H	B2241550	B84302503	B96L3327AH
	EH7534H	EHD7534H	EHP7534H	B2241549	B84304101	B96L3049AH
	EH7535H	EHD7535H	EHP7535H	B2241W3	B84301713B	B96L3353AH
	EH7536H	EHD7536H	EHP7536H	B2241W1	B84304103	B96L3419AH
<b>B</b>	EH7531K	EHD7531K	EHP7531K	B2241W2	B84302491A	B96L2551AK
	EH7532K	EHD7532K	EHP7532K	B2241417	B8430976B	B96L3257AH
	EH7533K	EHD7533K	EHP7533K	B2241550	B84302503	B96L2720BK
	EH7534K	EHD7534K	EHP7534K	B2241549	B84303342	B96L3049AH
	EH7535K	EHD7535K	EHP7535K	B2241W3	B84302417B	B96L2562AK
	EH7536K	EHD7536K	EHP7536K	B2241W1	B84303258	B96L3419AH
Price		<b>4,000JPY</b> /piece	<b>17,600JPY</b> /piece	<b>3,200JPY</b> /piece	<b>6,600JPY</b> /piece	<b>6,600JPY</b> /box
Number of panel per package		10 pieces/box (Ordering Unit 1piece)	1piece	5 pieces/box	10 pieces/box <sup>*)</sup> (Ordering Unit 1piece) Caulking(600ml)10pieces, Primer,brush,nozzle2pieces	1 set/box Inorganic ever-drying type Paint Base(9g)1piece, Hardener(7g)1piece, Primer(7.5g)1piece,brush2pieces

\*1 The dedicated primer (part number B85AA or B85BB) will be shipped at the same time.

# Smash Line 15

Coating performance	Weather resistance	Installation
Photocatalytic Self-cleaning	Weather resistance grade ★★★	Installation Horizontal

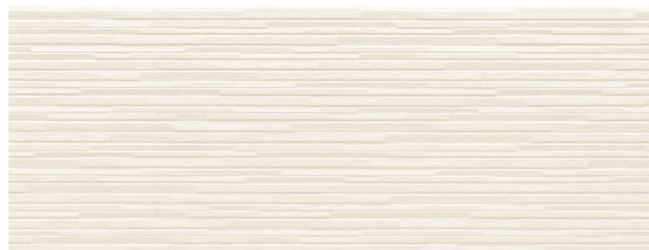

EH4221K

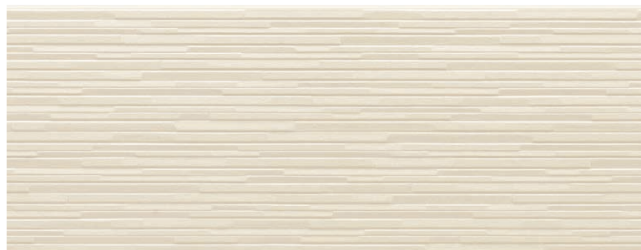

EH4222K



EH4223K



EH4224K



EH4225K

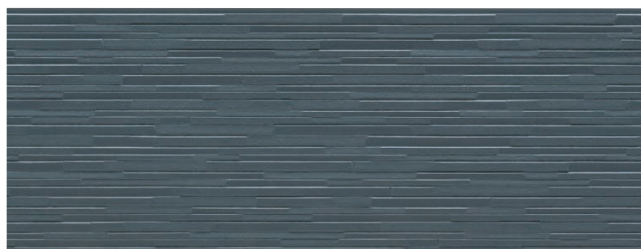

EH4226K



EH4227K



EH4228K

## ■ Specifications

Size	15×455(exposed width)×3030mm
Price	<b>8,600JPY/piece</b> 6,240JPY/m <sup>2</sup>
Number of panel per package	2pieces
Coverage	1.38m <sup>2</sup> /piece
Weight	Approx. 24kg/piece

## ■ Outside corner

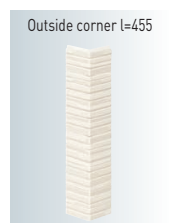

15×outside:90(inside:75)  
×455(exposed width)

## ■ Accessories list

Genuine accessories are required to install siding panels

Panel	Accessories	Outside corner l=455	Caulking (Holder set: B80E)	Repair Paint
EH4221K		EHD4221K	B84302491A	B962551BK
EH4222K		EHD4222K	B8430746	B96746BK
EH4223K		EHD4223K	B84302503	B962720AK
EH4224K		EHD4224K	B8430709	B96709GK
EH4225K		EHD4225K	B8430495	B96644BK
EH4226K		EHD4226K	B84301758A	B96747CK
EH4227K		EHD4227K	B84303044	B963167AK
EH4228K		EHD4228K	B84303045	B963224AK
Price		<b>4,000JPY/piece</b>	<b>6,600JPY/piece</b>	<b>6,600JPY/box</b>
Number of panel per package	10 pieces/box (Ordering Unit 1piece)	10 pieces/box <sup>*1</sup> (Ordering Unit 1piece)		1 set/box
		Caulking(600ml)10pieces, Primer,brush,nozzle2pieces <small>*Holder set are sold separately</small>		Inorganic ever-drying type Paint Base(9g)1piece, Hardener(7g)1piece, Primer(7.5g)1piece,brush2pieces

\*1 The dedicated primer (part number B85AA or B85BB) will be shipped at the same time.

# Placido 15

Coating performance	Weather resistance	Installation
Photocatalytic Self-cleaning	Weather resistance grade ★★★	Installation Horizontal



EH3871H



EH38710H



EH38711H

## Specifications

Size	15×455(exposed width)×3030mm
Price	<b>8,600JPY</b> /piece 6,240JPY/m <sup>2</sup>
Number of panel per package	2pieces
Coverage	1.38m <sup>2</sup> /piece
Weight	Approx. 23kg/piece

## Outside corner



## Accessories list

Genuine accessories are required to install siding panels

Panel	Accessories	Outside corner l=455	Caulking (Holder set: B80E)	Repair Paint
EH3871H		EHD3871H	B8430495	B961602CH
EH38710H		EHD38710H	B84302491A	B962597CH
EH38711H		EHD38711H	B8430976	B962818AK
Price		<b>4,000JPY</b> /piece	<b>6,600JPY</b> /piece	<b>6,600JPY</b> /box
Number of panel per package		10 pieces/box (Ordering Unit 1piece)	10 pieces/box <sup>*1</sup> (Ordering Unit 1piece) Caulking(600ml)10pieces, Primer,brush,nozzle2pieces <small>*Holder set are sold separately</small>	1 set/box Inorganic ever-drying type Paint Base(9g)1piece, Hardener(7g)1piece, Primer(7.5g)1piece,brush2pieces

<sup>\*1</sup> The dedicated primer (part number B85AA or B85BB) will be shipped at the same time.





Neorock Hydrophilic 16  
Mortan  
NW7602U

## Neorock Hydrophilic 16

New Ridge Wave 16  
 New slim stone  
 Natural Brick 16  
 Drawer Tile 16  
 Sephiro Wood 16  
 Carnac 16  
 Ahmar Wood  
 Simple Stripe 16  
 Modern Slit 16  
 Mortan  
 Knitty 16  
 Fiotto 16  
 Strahl 16

### ■ Joint Alignment & Connection Sections

#### Joint Alignment with Caulking

- To enhance the natural appearance of the design, the joint width intentionally varies.  
In addition, the joints on both sides of the caulking may be misaligned by approximately 3mm.
- The joint width varies to create a natural design expression.
- The joints on either side of the caulking may be offset by around 3mm.

#### Connection Sections

A joint is placed every approx. 455mm in the vertical direction.  
Depending on lighting conditions, sunlight, or viewing angle, subtle shadows or slight gaps may appear along the joint lines.

### ■ Performance List

item	unit	Neorock Hydrophilic 16	note
		16mm thickness	
specific gravity	—	1.0*	Drying at 105°C for 24 hours
Water content	%	20 or under	JISA5422
Water absorption rate	%	50 or under	Water absorption 24h→105°C 24h
Bending Failure Load	N	785 or over	JISA5422
Impact resistance	—	Passed	JISA5422

\*These are our measured values.

# New Ridge Wave 16

Coating performance	Weather resistance	Installation
Hydrophilic Self-cleaning	Weather resistance grade ★	Installation Horizontal



**G** NW7591A  
**J** NW7591K



**G** NW7592A  
**J** NW7592K



**G** NW7593A  
**J** NW7593K

## Specifications

Size	16×455(exposed width)×3030mm
Price	<b>7,800JPY</b> /piece 5,660JPY/m <sup>2</sup>
Number of panel per package	2pieces
Coverage	1.38m <sup>2</sup> /piece
Weight	Approx. 21kg/piece

## Outside corner

Outside corner l=455

16×outside:91(inside:75)  
×455(exposed width)

## Accessories list

Genuine accessories are required to install siding panels

Accessories		Outside corner l=455	Caulking (Holder set: B80E)	Repair Paint	
Panel					
<b>G</b>	NW7591A	NWD7591A	B8430495A	B93HB3106BA(Light color)	B93HB3073BA(Dark color)
	NW7592A	NWD7592A	B84302873	B93HB3003CA(Light color)	B93HB3074BA(Dark color)
	NW7593A	NWD7593A	B84303971	B93HB2632DA(Dark color)	B93HB3319AA(Light color)
<b>J</b>	NW7591K	NWD7591K	B8430495A	B93HB3106BA(Light color)	B93HB3073BA(Dark color)
	NW7592K	NWD7592K	B84302873	B93HB3003CA(Light color)	B93HB3074BA(Dark color)
	NW7593K	NWD7593K	B84303971	B93HB2632DA(Dark color)	B93HB3319AA(Light color)
Price		<b>4,000JPY</b> /piece	<b>6,600JPY</b> /piece	<b>2,900JPY</b> /bottle	
Number of panel per package		10 pieces/box (Ordering Unit 1piece)	10 pieces/box* (Ordering Unit 1piece) Caulking(600ml)10pieces, Primer,brush,nozzle2pieces	60g/bottle	
*Holder set are sold separately					

# New Slim Stone

Coating performance	Weather resistance	Installation
Hydrophilic Self-cleaning	Weather resistance grade ★	Installation Horizontal and Vertical



**G** NW4691A  
**J** NW4691K



**G** NW4694A  
**J** NW4694K



**G** NW4696A  
**J** NW4696K



**G** NW4697A  
**J** NW4697K



**G** NW4698A  
**J** NW4698K



**G** NW4699A  
**J** NW4699K



**G** NW46910A  
**J** NW46910K

## Specifications

Size	16×455(exposed width)×3030mm
Price	<b>7,800JPY/piece</b> 5,660JPY/m <sup>2</sup>
Number of panel per package	2pieces
Coverage	1.38m <sup>2</sup> /piece
Weight	Approx. 21kg/piece

## Outside corner

Outside corner l=455

16×outside:91(inside:75)  
×455(exposed width)

Outside corner l=3030

16×outside:91(inside:75)  
×3030

Shiplap corner

Vertical installation with clips

## Accessories list

Genuine accessories are required to install siding panels

Accessories		Outside corner l=455	Outside corner l=3030	Through Wall Flashing l=3030	Caulking (Holder set: B80E)	Repair Paint	
<b>G</b>	NW4691A	NWD4691A	NWP4691A	B2241W2	B84301944	B93HB2531BA	—
	NW4694A	NWD4694A	NWP4694A	B2241550	B84301935A	B93HB2533AA(Light color)	B93HB2535AA(Dark color)
	NW4696A	NWD4696A	NWP4696A	B2241W4	B84301937	B93HB1623AA(Dark color)	B93HB2666AA(Light color)
	NW4697A	NWD4697A	NWP4697A	B2241427	B84302970	B93HB2620AA	—
	NW4698A	NWD4698A	NWP4698A	B2241459	B84302837	B93HB2616AA	—
	NW4699A	NWD4699A	NWP4699A	B22413114	B84303840	B93HB2716CA(Dark color)	B93HB3220AA(Light color)
	NW46910A	NWD46910A	NWP46910A	B2241W3	B84303841	B93HB2533BA	—
<b>J</b>	NW4691K	NWD4691K	NWP4691K	B2241W2	B84301944	B93HB3160BNK	—
	NW4694K	NWD4694K	NWP4694K	B2241550	B84301935A	B93HB3183ANK(Light color)	B93HB3187ANK(Dark color)
	NW4696K	NWD4696K	NWP4696K	B2241W4	B84301937	B93HB3185ANK(Dark color)	B93HB3189ANK(Light color)
	NW4697K	NWD4697K	NWP4697K	B2241427	B84302970	B93HB3161ANK	—
	NW4698K	NWD4698K	NWP4698K	B2241459	B84302837	B93HB3163ANK	—
	NW4699K	NWD4699K	NWP4699K	B22413114	B84303840	B93HB3235ANK(Dark color)	B93HB3238ANK(Light color)
	NW46910K	NWD46910K	NWP46910K	B2241W3	B84303841	B93HB3183BNK	—
Price	4,000JPY/piece	17,600JPY/piece	3,200JPY/piece	6,600JPY/piece	2,900JPY/bottle		
Number of panel per package	10 pieces/box (Ordering Unit 1piece)	1piece	5 pieces/box	10 pieces/box*1(Ordering Unit 1piece) Caulking(600ml)10pieces, Primer,brush, nozzle2pieces, *Holder set are sold separately	60g/bottle		

\*1 The dedicated primer (part number B85AA or B85BB) will be shipped at the same time.

# Natural Brick 16

Coating performance	Weather resistance	Installation
Hydrophilic Self-cleaning	Weather resistance grade ★	Installation Horizontal



NW3835K



NW3836K

## Specifications

Size	16×455(exposed width)×3030mm
Price	<b>7,800JPY</b> /piece 5,660JPY/m <sup>2</sup>
Number of panel per package	2pieces
Coverage	1.38m <sup>2</sup> /piece
Weight	Approx. 20kg/piece

## Outside corner

Outside corner l=455

16×outside:91(inside:75)  
×455(exposed width)

## Accessories list

Genuine accessories are required to install siding panels

Panel	Accessories			
	Outside corner l=455	Caulking (Holder set: B80E)	Repair Paint	
NW3835K	NWD3835K	B8430401	B93HB3155ANK(Dark color)	B93HB3173ANK(Light color)
NW3836K	NWD3836K	B84302491C	B93HB3164ANK	—
Price	4,000JPY/piece	6,600JPY/piece	2,900JPY/bottle	
Number of panel per package	10 pieces/box (Ordering Unit 1piece)	10 pieces/box*1 (Ordering Unit 1piece)	60g/bottle	
		Caulking(600ml)10pieces, Primer,brush,nozzle2pieces		
*Holder set are sold separately				

\*1 The dedicated primer (part number B85AA or B85BB) will be shipped at the same time.

# Drawer Tile 16

Coating performance	Weather resistance	Installation
Hydrophilic Self-cleaning	Weather resistance grade ★	Installation Horizontal



NW4525A



NW4526A



NW4527A

## Specifications

Size	16×455(exposed width)×3030mm
Price	<b>7,800JPY/piece</b> 5,660JPY/m <sup>2</sup>
Number of panel per package	2pieces
Coverage	1.38m <sup>2</sup> /piece
Weight	Approx. 21kg/piece

## Outside corner

Outside corner l=455

16×outside:91(inside:75)  
×455(exposed width)

## Accessories list

Genuine accessories are required to install siding panels

Panel	Accessories	Outside corner l=455	Caulking (Holder set: B80E)	Repair Paint	
NW4525A		NWD4525A	B84304111	B93HB2526AA(Dark color)	B93HB3429AA(Light color)
NW4526A		NWD4526A	B84304112	B93HB3211AA(Dark color)	B93HB3430AA(Light color)
NW4527A		NWD4527A	B84304114	B93HB2632CA(Dark color)	B93HB2535BA(Light color)
Price		4,000JPY/piece	6,600JPY/piece	2,900JPY/bottle	
Number of panel per package	10 pieces/box (Ordering Unit 1piece)	10 pieces/box <sup>*1</sup> (Ordering Unit 1piece)		60g/bottle	
		Caulking(600ml)10pieces, Primer,brush,nozzle2pieces			
		*Holder set are sold separately			

\*1 The dedicated primer (part number B85AA or B85BB) will be shipped at the same time.

# Sephiro Wood 16

Coating performance	Weather resistance	Installation
Hydrophilic Self-cleaning	Weather resistance grade ★	Installation Horizontal and Vertical



NW4054K



NW4056K



NW4057K



NW4058K



NW4059K



NW40510K

## Specifications

Size	16×455(exposed width)×3030mm
Price	<b>7,800JPY</b> /piece 5,660JPY/m <sup>2</sup>
Number of panel per package	2pieces
Coverage	1.38m <sup>2</sup> /piece
Weight	Approx. 20kg/piece

## Outside corner

Outside corner l=455      Outside corner l=3030      Shiplap corner

Vertical installation with clips

16×outside:91(inside:75)×455(exposed width)      16×outside:91(inside:75)×3030

## Accessories list

Genuine accessories are required to install siding panels

Panel	Outside corner l=455	Outside corner l=3030	Through Wall Flashing l=3030	Caulking (Holder set: B80E)	Repair Paint
NW4054K	NWD4054K	NWP4054K	B2241W1	B8430713B	B93HB3182BNK
NW4056K	NWD4056K	NWP4056K	B2241W4	B84304040	B93HB3156BNK
NW4057K	NWD4057K	NWP4057K	B2241458	B84301698	B93HB3162ANK
NW4058K	NWD4058K	NWP4058K	B2241423	B84304030	B93HB3155CNK
NW4059K	NWD4059K	NWP4059K	B22413060	B8430708	B93HB3299BNK
NW40510K	NWD40510K	NWP40510K	B2241550	B84301781	B93HB3182CNK
Price	<b>4,000JPY</b> /piece	<b>17,600JPY</b> /piece	<b>3,200JPY</b> /piece	<b>6,600JPY</b> /piece	<b>2,900JPY</b> /bottle
Number of panel per package	10 pieces/box (Ordering Unit 1piece)	1piece	5 pieces/box	10 pieces/box <sup>*1</sup> (Ordering Unit 1piece) Caulking(400ml)10pieces, Primer,brush,nozzle2pieces	60g/bottle
				*Holder set are sold separately	

\*1 The dedicated primer (part number B85AA or B85BB) will be shipped at the same time.

# Carnac 16

Coating performance	Weather resistance	Installation
Hydrophilic Self-cleaning	Weather resistance grade ★	Installation Horizontal



**G** NW7571A  
**H** NW7571U  
**F** NW7571K



**G** NW7572A  
**H** NW7572U  
**F** NW7572K



**G** NW7573A  
**H** NW7573U  
**F** NW7573K



**G** NW7574A  
**H** NW7574U  
**F** NW7574K



**G** NW7575A  
**H** NW7575U  
**F** NW7575K



**G** NW7576A  
**H** NW7576U  
**F** NW7576K



**G** NW7577A  
**H** NW7577U  
**F** NW7577K

## Specifications

Size	16×455(exposed width)×3030mm
Price	<b>7,800JPY</b> /piece 5,660JPY/m <sup>2</sup>
Number of panel per package	2pieces
Coverage	1.38m <sup>2</sup> /piece
Weight	Approx. 21kg/piece

## Outside corner



## Accessories list

Genuine accessories are required to install siding panels

Panel	Accessories	Outside corner l=455	Caulking (Holder set: B80E)	Repair Paint	
<b>G</b>	NW7571A	NWD7571A	B84302491	B93HB2531AU	
	NW7572A	NWD7572A	B8430557	B93HB3156ANK	
	NW7573A	NWD7573A	B8430747	B93HB2583AU	
	NW7574A	NWD7574A	B8430713A	B93HB3152ANK	
	NW7575A	NWD7575A	B84303051	B93HB3167ANK	
	NW7576A	NWD7576A	B84302767A	B93HB3434ANK	
<b>H</b>	NW7577A	NWD7577A	B84303045	B93HB3224BNK	
	NW7571U	NWD7571U	B84302491	B93HB3160ANK	
	NW7572U	NWD7572U	B8430557	B93HB3156ANK	
	NW7573U	NWD7573U	B8430747	B93HB2583AU	
	NW7574U	NWD7574U	B8430713A	B93HB3152ANK	
	NW7575U	NWD7575U	B84303051	B93HB3167ANK	
<b>F</b>	NW7576U	NWD7576U	B84302767B	B93HB3434ANK	
	NW7577U	NWD7577U	B84303045	B93HB3224BNK	
	NW7571K	NWD7571K	B84302491	B93HB3160ANK	
	NW7572K	NWD7572K	B8430557	B93HB3156ANK	
	NW7573K	NWD7573K	B8430747	B93HB3166ANK	
	NW7574K	NWD7574K	B8430713A	B93HB3152ANK	
		NW7575K	NWD7575K	B84303051	B93HB3167ANK
		NW7576K	NWD7576K	B84302767A	B93HB3434ANK
		NW7577K	NWD7577K	B84303045	B93HB3224BNK
	Price	<b>4,000JPY</b> /piece	<b>6,600JPY</b> /piece	<b>2,900JPY</b> /bottle	
	Number of panel per package	10 pieces/box (Ordering Unit 1piece)	10 pieces/box* (Ordering Unit 1piece) Caulking(60ml)10pieces, Primer,brush,nozzle2pieces *Holder set are sold separately	60g/bottle	

\*1 The dedicated primer (part number B85AA or B85BB) will be shipped at the same time.

# Ahmar Wood

Coating performance	Weather resistance	Installation
Hydrophilic Self-cleaning	Weather resistance grade ★	Installation Horizontal and Vertical



NW4541A



NW4542A



NW4543A

## Specifications

Size	16×455(exposed width)×3030mm
Price	<b>7,800JPY</b> /piece 5,660JPY/m <sup>2</sup>
Number of panel per package	2pieces
Coverage	1.38m <sup>2</sup> /piece
Weight	Approx. 21kg/piece

## Outside corner

Shiplap corner

Vertical installation with clips

16×outside:91(inside:75) ×455(exposed width)

16×outside:91(inside:75) ×3030

## Accessories list

Genuine accessories are required to install siding panels

Panel	Outside corner l=455	Outside corner l=3030	Through Wall Flashing l=3030	Caulking (Holder set: B80E)	Repair Paint
NW4541A	NWD4541A	NWP4541A	B2241W2	B84302491	B93HB2531AA
NW4542A	NWD4542A	NWP4542A	B2241476	B84304031	B93HB2716AA
NW4543A	NWD4543A	NWP4543A	B2241W3	B84302417B	B93HB2417AA
Price	<b>4,000JPY</b> /piece	<b>17,600JPY</b> /piece	<b>3,200JPY</b> /piece	<b>6,600JPY</b> /piece	<b>2,900JPY</b> /bottle
Number of panel per package	10 pieces/box (Ordering Unit 1piece)	1piece	5 pieces/box	10 pieces/box <sup>*1</sup> (Ordering Unit 1piece) Caulking(600ml)10pieces, Primer,brush,nozzle2pieces	60g/bottle
				*Holder set are sold separately	

\*1 The dedicated primer (part number B85AA or B85BB) will be shipped at the same time.

# Simple Stripe 16

Coating performance	Weather resistance	Installation
Hydrophilic Self-cleaning	Weather resistance grade ★	Installation Horizontal and Vertical



NW7621U



NW7622U



NW7623U



NW7624U

## Specifications

Size	16×455(exposed width)×3030mm
Price	<b>7,800JPY</b> /piece 5,660JPY/m <sup>2</sup>
Number of panel per package	2pieces
Coverage	1.38m <sup>2</sup> /piece
Weight	Approx. 21kg/piece

## Outside corner

Outside corner l=455      Outside corner l=3030

Shiplap corner  
Vertical installation with clips

16×outside:91(inside:75) ×455(exposed width)      16×outside:91(inside:75) ×3030

## Accessories list

Genuine accessories are required to install siding panels

Panel	Outside corner l=455	Outside corner l=3030	Through Wall Flashing l=3030	Caulking (Holder set: B80E)	Repair Paint
NW7621U	NWD7621U	NWP7621U	B2241549	B84303212	B93HB3391ANK
NW7622U	NWD7622U	NWP7622U	B2241468	B84303431	B93HB3431AU
NW7623U	NWD7623U	NWP7623U	B2241462	B8430462A	B93HB2583AU
NW7624U	NWD7624U	NWP7624U	B2241W1	B84303045	B93HB3222AU
Price	<b>4,000JPY</b> /piece	<b>17,600JPY</b> /piece	<b>3,200JPY</b> /piece	<b>6,600JPY</b> /piece	<b>2,900JPY</b> /bottle
Number of panel per package	10 pieces/box (Ordering Unit 1piece)	1piece	5 pieces/box	10 pieces/box <sup>*1</sup> (Ordering Unit 1piece) Caulking(600ml)10pieces, Primer,brush,nozzle2pieces <small>*Holder set are sold separately</small>	60g/bottle

\*1 The dedicated primer (part number B85AA or B85BB) will be shipped at the same time.

# Modern Slit 16

Coating performance	Weather resistance	Installation
Hydrophilic Self-cleaning	Weather resistance grade ★	Installation Horizontal and Vertical



NW7611U



NW7612U



NW7613U



NW7614U



NW7615U



NW7616U

## Specifications

Size	16×455(exposed width)×3030mm
Price	<b>7,800JPY</b> /piece 5,660JPY/m <sup>2</sup>
Number of panel per package	2pieces
Coverage	1.38m <sup>2</sup> /piece
Weight	Approx. 22kg/piece

## Outside corner

Outside corner l=455    Outside corner l=3030    Shiplap corner

Vertical installation with clips

16×outside:91(inside:75) ×455(exposed width)    16×outside:91(inside:75) ×3030

## Accessories list

Genuine accessories are required to install siding panels

Panel	Outside corner l=455	Outside corner l=3030	Through Wall Flashing l=3030	Caulking (Holder set: B80E)	Repair Paint
NW7611U	NWD7611U	NWP7611U	B2241W2	B84302491C	B93HB2531AU
NW7612U	NWD7612U	NWP7612U	B2441462	B8430747	B93HB2583AU
NW7613U	NWD7613U	NWP7613U	B2241550	B84302503A	B93HB2525CU
NW7614U	NWD7614U	NWP7614U	B22413058	B84303044	B93HB3051AU
NW7615U	NWD7615U	NWP7615U	B2241557	B84301615	B93HB1765ANK
NW7616U	NWD7616U	NWP7616U	B2241W3	B8430713B	B93HB2416AA
Price	<b>4,000JPY</b> /piece	<b>17,600JPY</b> /piece	<b>3,200JPY</b> /piece	<b>6,600JPY</b> /piece	<b>2,900JPY</b> /bottle
Number of panel per package	10 pieces/box (Ordering Unit 1piece)	1piece	5 pieces/box	10 pieces/box <sup>*1</sup> (Ordering Unit 1piece) Caulking(600ml)10pieces, Primer,brush,nozzle2pieces <small>*Holder set are sold separately</small>	60g/bottle

\*1 The dedicated primer (part number B85AA or B85BB) will be shipped at the same time.

# Mortan

Coating performance	Weather resistance	Installation
Hydrophilic Self-cleaning	Weather resistance grade ★	Installation Horizontal and Vertical



NW7601U



NW7602U



NW7603U



NW7604U



NW7605U

## Specifications

Size	16×455(exposed width)×3030mm
Price	<b>7,800JPY</b> /piece 5,660JPY/m <sup>2</sup>
Number of panel per package	2pieces
Coverage	1.38m <sup>2</sup> /piece
Weight	Approx. 22kg/piece

## Outside corner

Outside corner l=455      Outside corner l=3030

16×outside:91(inside:75) ×455(exposed width)      16×outside:91(inside:75) ×3030

Shiplap corner  
Vertical installation with clips

## Accessories list

Genuine accessories are required to install siding panels

Panel	Outside corner l=455	Outside corner l=3030	Through Wall Flashing l=3030	Caulking (Holder set: B80E)	Repair Paint
NW7601U	NWD7601U	NWP7601U	B2241W2	B84302491C	B93HB2531AA
NW7602U	NWD7602U	NWP7602U	B2241550	B84302503	B93HB2525CU
NW7603U	NWD7603U	NWP7603U	B2241549	B84303212	B93HB3316ANK
NW7604U	NWD7604U	NWP7604U	B2241468	B84303431	B93HB3431AU
NW7605U	NWD7605U	NWP7605U	B2241W1	B84303045A	B93HB3222AA
Price	<b>4,000JPY</b> /piece	<b>17,600JPY</b> /piece	<b>3,200JPY</b> /piece	<b>6,600JPY</b> /piece	<b>2,900JPY</b> /bottle
Number of panel per package	10 pieces/box (Ordering Unit 1piece)	1piece	5 pieces/box	10 pieces/box <sup>*1</sup> (Ordering Unit 1piece) Caulking(600ml)10pieces, Primer,brush,nozzle2pieces <small>*Holder set are sold separately</small>	60g/bottle

\*1 The dedicated primer (part number B85AA or B85BB) will be shipped at the same time.

# Knitty 16

Coating performance	Weather resistance	Installation
Hydrophilic Self-cleaning	Weather resistance grade ★	Installation Horizontal and Vertical



NW4951U



NW4952U



NW4954U

## Specifications

Size	16×455(exposed width)×3030mm
Price	<b>7,800JPY</b> /piece 5,660JPY/m <sup>2</sup>
Number of panel per package	2pieces
Coverage	1.38m <sup>2</sup> /piece
Weight	Approx. 22kg/piece

## Outside corner

Outside corner l=455      Outside corner l=3030

16×outside:91(inside:75) ×455(exposed width)      16×outside:91(inside:75) ×3030

Shiplap corner  
Vertical installation with clips

## Accessories list

Genuine accessories are required to install siding panels

Panel	Outside corner l=455	Outside corner l=3030	Through Wall Flashing l=3030	Caulking (Holder set: B80E)	Repair Paint
NW4951U	NWD4951U	NWP4951U	B2241W2	B84302491C	B93HB2531AU
NW4952U	NWD4952U	NWP4952U	B2241512	B8430746	B93HB1439AU
NW4954U	NWD4954U	NWP4954U	B2241550	B84301843	B93HB2533CU
Price	<b>4,000JPY</b> /piece	<b>17,600JPY</b> /piece	<b>3,200JPY</b> /piece	<b>6,600JPY</b> /piece	<b>2,900JPY</b> /bottle
Number of panel per package	10 pieces/box (Ordering Unit 1piece)	1piece	5 pieces/box	10 pieces/box <sup>*1</sup> (Ordering Unit 1piece) Caulking(600ml)10pieces, Primer,brush,nozzle2pieces <small>*Holder set are sold separately</small>	60g/bottle

\*1 The dedicated primer (part number B85AA or B85BB) will be shipped at the same time.

# Fiotto 16

Coating performance	Weather resistance	Installation
Hydrophilic Self-cleaning	Weather resistance grade ★	Installation Horizontal and Vertical



**G** NW3751A  
**J** NW3751K



**G** NW3752A  
**J** NW3752K



**G** NW3753A  
**J** NW3753K



**G** NW3757A  
**J** NW3757K

## Specifications

Size	16×455(exposed width)×3030mm
Price	<b>7,800JPY</b> /piece 5,660JPY/m <sup>2</sup>
Number of panel per package	2pieces
Coverage	1.38m <sup>2</sup> /piece
Weight	Approx. 21kg/piece

## Outside corner

Outside corner l=455      Outside corner l=3030

Shiplap corner  
Vertical installation with clips

16×outside:91(inside:75)×455(exposed width)      16×outside:91(inside:75)×3030

## Accessories list

Genuine accessories are required to install siding panels

Accessories		Outside corner l=455	Outside corner l=3030	Through Wall Flashing l=3030	Caulking (Holder set: B80E)	Repair Paint
<b>G</b>	NW3751A	NWD3751A	NWP3751A	B2241W2	B8430577	B93HB2540AA
	NW3752A	NWD3752A	NWP3752A	B2241W2	B8430495	B93HB1438AA
	NW3753A	NWD3753A	NWP3753A	B2241578	B84301616	B93HB1622AA
	NW3757A	NWD3757A	NWP3757A	B2241W3	B8430713A	B93HB2416AA
<b>J</b>	NW3751K	NWD3751K	NWP3751K	B2241W2	B8430577	B93HB3170ANK
	NW3752K	NWD3752K	NWP3752K	B2241W2	B8430495	B93HB3143ANK
	NW3753K	NWD3753K	NWP3753K	B2241578	B84301616	B93HB3171ANK
	NW3757K	NWD3757K	NWP3757K	B2241W3	B8430713A	B93HB3152ANK
Price		<b>4,000JPY</b> /piece	<b>17,600JPY</b> /piece	<b>3,200JPY</b> /piece	<b>6,600JPY</b> /piece	<b>2,900JPY</b> /bottle
Number of panel per package		10 pieces/box (Ordering Unit 1piece)	1piece	5 pieces/box	10 pieces/box <sup>*1</sup> (Ordering Unit 1piece) Caulking(600ml)10pieces, Primer,brush,nozzle2pieces <small>*Holder set are sold separately</small>	60g/bottle

\*1 The dedicated primer (part number B85AA or B85BB) will be shipped at the same time.

# Strahl 16

Coating performance	Weather resistance	Installation
Hydrophilic Self-cleaning	Weather resistance grade ★	Installation Horizontal



NW4341A



NW4343A



NW4344A

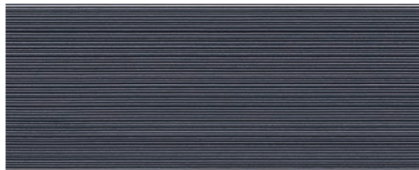

NW4346A



NW4347A



NW4349A

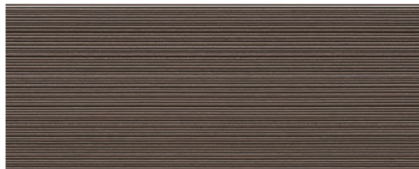

NW43410A



NW43411A

## Specifications

Size	16×455(exposed width)×3030mm
Price	<b>7,800JPY</b> /piece 5,660JPY/m <sup>2</sup>
Number of panel per package	2pieces
Coverage	1.38m <sup>2</sup> /piece
Weight	Approx. 22kg/piece

## Outside corner

Outside corner l=455

16×outside:91(inside:75)  
×455(exposed width)

## Accessories list

Genuine accessories are required to install siding panels

Panel	Accessories	Outside corner l=455	Caulking (Holder set: B80E)	Repair Paint
NW4341A		NWD4341A	B84302491	B93HB2531AA
NW4343A		NWD4343A	B8430746	B93HB1439CA
NW4344A		NWD4344A	B84302503	B93HB2525BA
NW4346A		NWD4346A	B8430747	B93HB2583AA
NW4347A		NWD4347A	B84303051	B93HB3051AA
NW4349A		NWD4349A	B84302715	B93HB2715BA
NW43410A		NWD43410A	B8430582	B93HB2528AA
NW43411A		NWD43411A	B84303215	B93HB3222AA
Price		<b>4,000JPY</b> /piece	<b>6,600JPY</b> /piece	<b>2,900JPY</b> /bottle
Number of panel per package		10 pieces/box (Ordering Unit 1piece)	10 pieces/box <sup>*1</sup> (Ordering Unit 1piece) Caulking(600ml)10pieces, Primer,brush, nozzle2pieces <small>*Holder set are sold separately</small>	60g/bottle

\*1 The dedicated primer (part number B85AA or B85BB) will be shipped at the same time.





Excellage Hydrophilic 15  
Bastia  
EW7724H

## Excellage Hydrophilic 15

Bastia  
 Silbus Tile 15  
 Pietra Relief  
 Lapis Wave  
 Elongated Stone  
 Traditional Border 15  
 Verde Brick  
 Baker Brick  
 Stable Tile  
 Cube Sucre 15  
 Scratch Cross  
 Bare Concrete 15  
 Luminous Wood  
 Clair Wood 15  
 Cimant Flat  
 Plaster Flat 15  
 Orden  
 Pebble  
 Elenore  
 Alivio  
 Smash Line 15  
 Placido 15  
 Luge 15

### ■ Joint Alignment & Connection Sections

#### Joint Alignment with Caulking

•To enhance the natural appearance of the design, the joint width intentionally varies.

In addition, the joints on both sides of the caulking may be misaligned by approximately 3mm.

•The joint width varies to create a natural design expression.

•The joints on either side of the caulking may be offset by around 3mm.

#### Connection Sections

A joint is placed every approx. 455mm in the vertical direction.

Depending on lighting conditions, sunlight, or viewing angle, subtle shadows or slight gaps may appear along the joint lines.

### ■ Performance List

item	unit	Excellage Hydrophilic 15	note
		15mm thickness	
specific gravity	—	1.1*	Drying at 105°C for 24 hours
Water content	%	20 or under	JISA5422
Water absorption rate	%	50 or under	Water absorption 24h→105°C 24h
Bending Failure Load	N	785 or over	JISA5422
Impact resistance	—	Passed	JISA5422

\*These are our measured values.

# Bastia

Coating performance	Weather resistance	Installation
Hydrophilic Self-cleaning	Weather resistance grade ★★	Installation Horizontal



EW7721H



EW7722H



EW7723H



EW7724H



EW7725H

## Specifications

Size	15×455(exposed width)×3030mm
Price	<b>6,500JPY</b> /piece 4,710JPY/m <sup>2</sup>
Number of panel per package	2pieces
Coverage	1.38m <sup>2</sup> /piece
Weight	Approx. 25kg/piece

## Outside corner



## Accessories list

Genuine accessories are required to install siding panels

Panel	Accessories			
	Outside corner l=455	Caulking (Holder set: B80E)	Repair Paint	
EW7721H	EWD7721H	B84304196	B93HB3259ANH	—
EW7722H	EWD7722H	B84304197	B93HB3256ANH	—
EW7723H	EWD7723H	B84303958	B93HB3059CNH (Light color)	B93HB3326BNH (Dark color)
EW7724H	EWD7724H	B84304199	B93HB3277ANH	—
EW7725H	EWD7725H	B84304200	B93HB3419BNH	—
Price	<b>3,900JPY</b> /piece	<b>6,600JPY</b> /piece	<b>2,900JPY</b> /bottle	
Number of panel per package	10 pieces/box (Ordering Unit 1piece)	10 pieces/box <sup>*1</sup> (Ordering Unit 1piece)	60g/bottle	
		Caulking(600ml)10pieces, Primer,brush,nozzle2pieces <small>*Holder set are sold separately</small>		

\*1 The dedicated primer (part number B85AA or B85BB) will be shipped at the same time.

# Silbus Tile 15

Coating performance	Weather resistance	Installation
Hydrophilic Self-cleaning	Weather resistance grade ★★	Installation Horizontal



EW37010K



EW37011K



EW37012K



EW37013K

## Specifications

Size	15×455(exposed width)×3030mm
Price	<b>6,500JPY</b> /piece 4,710JPY/m <sup>2</sup>
Number of panel per package	2pieces
Coverage	1.38m <sup>2</sup> /piece
Weight	Approx. 24kg/piece

## Outside corner



## Accessories list

Genuine accessories are required to install siding panels

Panel	Accessories	Outside corner l=455	Caulking (Holder set: B80E)	Repair Paint
EW37010K		EWD37010K	B8430495	B93HB2669ANK
EW37011K		EWD37011K	B8430580	B93HB1772ANK
EW37012K		EWD37012K	B84304040	B93HB2600DNK
EW37013K		EWD37013K	B84304073	B93HB743DNK
Price		<b>3,900JPY</b> /piece	<b>6,600JPY</b> /piece	<b>2,900JPY</b> /bottle
Number of panel per package		10 pieces/box (Ordering Unit 1piece)	10 pieces/box <sup>*1</sup> (Ordering Unit 1piece) Caulking(600ml)10pieces, Primer,brush,nozzle2pieces <small>*Holder set are sold separately</small>	60g/bottle

\*1 The dedicated primer (part number B85AA or B85BB) will be shipped at the same time.

# Pietra Relief

Coating performance	Weather resistance	Installation
Hydrophilic Self-cleaning	Weather resistance grade ★★	Installation Horizontal



EW7541H



EW7542H



EW7543H



EW7544H

## Specifications

Size	15×455(exposed width)×3030mm
Price	<b>6,500JPY</b> /piece 4,710JPY/m <sup>2</sup>
Number of panel per package	2pieces
Coverage	1.38m <sup>2</sup> /piece
Weight	Approx. 24kg/piece

## Outside corner



## Accessories list

Genuine accessories are required to install siding panels

Panel	Accessories	Outside corner l=455	Caulking (Holder set: B80E)	Repair Paint	
EW7541H		EWD7541H	B84304104	B93HB2581ANK	B93HB1602CNH (Light color) B93HB1602DNH (Dark color)
EW7542H		EWD7542H	B84304105	B93HB2597FNH (Light color)	B93HB2597GNH (Dark color) —
EW7543H		EWD7543H	B84304106	B93HB783DNH	B93HB743DNK (Light color) B93HB783ENH (Dark color)
EW7544H		EWD7544H	B84304107	B93HB1708HNNH (Light color)	B93HB1708JNHH (Dark color) —
Price		<b>3,900JPY</b> /piece	<b>6,600JPY</b> /piece	<b>2,900JPY</b> /bottle	
Number of panel per package		10 pieces/box (Ordering Unit 1piece)	10 pieces/box <sup>*1</sup> (Ordering Unit 1piece) Caulking(600ml)10pieces, Primer,brush,nozzle2pieces	60g/bottle	
				*Holder set are sold separately	

\*1 The dedicated primer (part number B85AA or B85BB) will be shipped at the same time.

# Lapis Wave

Coating performance	Weather resistance	Installation
Hydrophilic Self-cleaning	Weather resistance grade ★★	Installation Horizontal



EW7333K



EW7334K



EW7335K



EW7336K

## Specifications

Size	15×455(exposed width)×3030mm
Price	<b>6,500JPY</b> /piece 4,710JPY/m <sup>2</sup>
Number of panel per package	2pieces
Coverage	1.38m <sup>2</sup> /piece
Weight	Approx. 24kg/piece

## Outside corner



## Accessories list

Genuine accessories are required to install siding panels

Panel	Accessories	Outside corner l=455	Caulking (Holder set: B80E)	Repair Paint
EW7333K		EWD7333K	B8430707C	B93HB707ANK
EW7334K		EWD7334K	B8430713	B93HB743BNK
EW7335K		EWD7335K	B84304036	B93HB2551BNK
EW7336K		EWD7336K	B84302873	B93HB2818DNK
Price		<b>3,900JPY</b> /piece	<b>6,600JPY</b> /piece	<b>2,900JPY</b> /bottle
Number of panel per package		10 pieces/box (Ordering Unit 1piece)	10 pieces/box <sup>*1</sup> (Ordering Unit 1piece) Caulking(600ml)10pieces, Primer,brush,nozzle2pieces <small>*Holder set are sold separately</small>	60g/bottle

\*1 The dedicated primer (part number B85AA or B85BB) will be shipped at the same time.

# Elongated Stone

Coating performance	Weather resistance	Installation
Hydrophilic Self-cleaning	Weather resistance grade ★★	Installation Horizontal and Vertical



EW7344K



EW7345K



EW7346K



EW7347K



EW7348K



EW7349K



EW73410K

## Specifications

Size	15×455(exposed width)×3030mm
Price	<b>6,500JPY</b> /piece 4,710JPY/m <sup>2</sup>
Number of panel per package	2pieces
Coverage	1.38m <sup>2</sup> /piece
Weight	Approx. 24kg/piece

## Outside corner

Outside corner l=455      Outside corner l=3030

Shiplap corner

Vertical installation with clips

15×outside:90(inside:75) ×455(exposed width)      15×outside:90(inside:75) ×3030

## Accessories list

Genuine accessories are required to install siding panels

Panel	Accessories		Through Wall Flashing l=3030	Caulking (Holder set: B80E)	Repair Paint	
	Outside corner l=455	Outside corner l=3030				
EW7344K	EWD7344K	EWP7344K	B2241557	B84301937	—	B93HB1454BNK
EW7345K	EWD7345K	EWP7345K	B2241550	B84301935A	—	B93HB753ANK
EW7346K	EWD7346K	EWP7346K	B2241W3	B84304073	—	B93HB743CNK
EW7347K	EWD7347K	EWP7347K	B2241549	B84303841	B93HB753ANK (Light color)	B93HB4074ANK (Dark color)
EW7348K	EWD7348K	EWP7348K	B2241512	B8430495	—	B93HB2669ANK
EW7349K	EWD7349K	EWP7349K	B2241512	B84304069	—	B93HB4069ANK
EW73410K	EWD73410K	EWP73410K	B2241427	B84304070	—	B93HB4070BNK
Price	<b>3,900JPY</b> /piece	<b>17,100JPY</b> /piece	<b>3,200JPY</b> /piece	<b>6,600JPY</b> /piece	<b>2,900JPY</b> /bottle	
Number of panel per package	10 pieces/box (Ordering Unit 1piece)	1piece	5 pieces/box	10 pieces/box*1 (Ordering Unit 1piece) Caulking(600ml)10pieces, Primer,brush,nozzle2pieces *Holder set are sold separately	60g/bottle	

\*1 The dedicated primer (part number B85AA or B85BB) will be shipped at the same time.

# Traditional Border 15

Coating performance	Weather resistance	Installation
Hydrophilic Self-cleaning	Weather resistance grade ★★	Installation Horizontal and Vertical



EW3679K



EW36710K



EW36711K

## Specifications

Size	15×455(exposed width)×3030mm
Price	<b>6,500JPY</b> /piece 4,710JPY/m <sup>2</sup>
Number of panel per package	2pieces
Coverage	1.38m <sup>2</sup> /piece
Weight	Approx. 24kg/piece

## Outside corner

Outside corner l=455



15×outside:90(inside:75)  
×455(exposed width)

Outside corner l=3030



15×outside:90(inside:75)  
×3030

Shiplap corner



Vertical installation with clips

## Accessories list

Genuine accessories are required to install siding panels

Panel	Outside corner l=455	Outside corner l=3030	Through Wall Flashing l=3030	Caulking (Holder set: B80E)	Repair Paint
EW3679K	EWD3679K	EWP3679K	B2241W3	B8430709	B93HB743CNK
EW36710K	EWD36710K	EWP36710K	B2241512	B8430746	B93HB644ENK
EW36711K	EWD36711K	EWP36711K	B2241557	B84302503	B93HB1454BNK
Price	<b>3,900JPY</b> /piece	<b>17,100JPY</b> /piece	<b>3,200JPY</b> /piece	<b>6,600JPY</b> /piece	<b>2,900JPY</b> /bottle
Number of panel per package	10 pieces/box (Ordering Unit 1piece)	1piece	5 pieces/box	10 pieces/box*1 (Ordering Unit 1piece) Caulking(600ml)10pieces, Primer,brush,nozzle2pieces	60g/bottle
				*Holder set are sold separately	

\*1 The dedicated primer (part number B85AA or B85BB) will be shipped at the same time.

# Verde Brick

Coating performance	Weather resistance	Installation
Hydrophilic Self-cleaning	Weather resistance grade ★★	Installation Horizontal



EW7352H



EW7355H

## Specifications

Size	15×455(exposed width)×3030mm
Price	<b>6,500JPY</b> /piece 4,710JPY/m <sup>2</sup>
Number of panel per package	2pieces
Coverage	1.38m <sup>2</sup> /piece
Weight	Approx. 24kg/piece

## Outside corner

Outside corner l=455

15×outside:90(inside:75)  
×455(exposed width)

## Accessories list

Genuine accessories are required to install siding panels

Panel	Accessories			
	Outside corner l=455	Caulking (Holder set: B80E)	Repair Paint	
EW7352H	EWD7352H	B8430746	B93HB2597CNH (Light color)	B93HB2597DNH (Dark color)
EW7355H	EWD7355H	B84304028	B93HB2605BNH (Light color)	B93HB2605CNH (Dark color)
Price	<b>3,900JPY</b> /piece	<b>6,600JPY</b> /piece	<b>2,900JPY</b> /bottle	
Number of panel per package	10 pieces/box (Ordering Unit 1piece)	10 pieces/box <sup>*1</sup> (Ordering Unit 1piece)	60g/bottle	
		Caulking(600ml)10pieces, Primer,brush,nozzle2pieces <small>*Holder set are sold separately</small>		

\*1 The dedicated primer (part number B85AA or B85BB) will be shipped at the same time.

## Excellage Hydrophilic 15

# Baker Brick

Coating performance	Weather resistance	Installation
Hydrophilic Self-cleaning	Weather resistance grade ★★	Installation Horizontal



EW4274K



EW4275K



EW4276K

### Specifications

Size	15×455(exposed width)×3030mm
Price	<b>6,500JPY</b> /piece 4,710JPY/m <sup>2</sup>
Number of panel per package	2pieces
Coverage	1.38m <sup>2</sup> /piece
Weight	Approx. 24kg/piece

### Outside corner



### Accessories list

Genuine accessories are required to install siding panels

Panel	Accessories	Outside corner l=455	Caulking (Holder set: B80E)	Repair Paint
EW4274K		EWD4274K	B84304069	B93HB2551DNK
EW4275K		EWD4275K	B84302969	B93HB707ANK
EW4276K		EWD4276K	B8430713	B93HB743CNK
Price		<b>3,900JPY</b> /piece	<b>6,600JPY</b> /piece	<b>2,900JPY</b> /bottle
Number of panel per package		10 pieces/box (Ordering Unit 1piece)	10 pieces/box <sup>*1</sup> (Ordering Unit 1piece) Caulking(600ml)10pieces, Primer,brush,nozzle2pieces	60g/bottle
			*Holder set are sold separately	

\*1 The dedicated primer (part number B85AA or B85BB) will be shipped at the same time.

# Stable Tile

Coating performance	Weather resistance	Installation
Hydrophilic Self-cleaning	Weather resistance grade ★★	Installation Horizontal



EW4416K



EW4417K



EW4418K

## Specifications

Size	15×455(exposed width)×3030mm
Price	<b>6,500JPY</b> /piece 4,710JPY/m <sup>2</sup>
Number of panel per package	2pieces
Coverage	1.38m <sup>2</sup> /piece
Weight	Approx. 23kg/piece

## Outside corner



## Accessories list

Genuine accessories are required to install siding panels

Panel	Accessories	Outside corner l=455	Caulking (Holder set: B80E)	Repair Paint
EW4416K		EWD4416K	B84302491A	B93HB2669ANK
EW4417K		EWD4417K	B84302503	B93HB1454BNK
EW4418K		EWD4418K	B84302818	B93HB2600DNK
Price		<b>3,900JPY</b> /piece	<b>6,600JPY</b> /piece	<b>2,900JPY</b> /bottle
Number of panel per package		10 pieces/box (Ordering Unit 1piece)	10 pieces/box <sup>*1</sup> (Ordering Unit 1piece) Caulking(600ml)10pieces, Primer,brush,nozzle2pieces	60g/bottle
			*Holder set are sold separately	

\*1 The dedicated primer (part number B85AA or B85BB) will be shipped at the same time.

# Scratch Cross

Coating performance	Weather resistance	Installation
Hydrophilic Self-cleaning	Weather resistance grade ★★	Installation Horizontal



EW4044K



EW4046K



EW4047K

## Specifications

Size	15×455(exposed width)×3030mm
Price	<b>6,500JPY</b> /piece 4,710JPY/m <sup>2</sup>
Number of panel per package	2pieces
Coverage	1.38m <sup>2</sup> /piece
Weight	Approx. 24kg/piece

## Outside corner

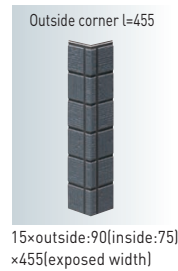

## Accessories list

Genuine accessories are required to install siding panels

Panel	Accessories	Outside corner l=455	Caulking (Holder set: B80E)	Repair Paint
EW4044K		EWD4044K	B8430581	B93HB747ANK
EW4046K		EWD4046K	B8430709	B93HB743BNK
EW4047K		EWD4047K	B84302491A	B93HB2669CNK
Price		<b>3,900JPY</b> /piece	<b>6,600JPY</b> /piece	<b>2,900JPY</b> /bottle
Number of panel per package		10 pieces/box (Ordering Unit 1piece)	10 pieces/box <sup>*1</sup> (Ordering Unit 1piece) Caulking(600ml)10pieces, Primer,brush,nozzle2pieces	60g/bottle
			*Holder set are sold separately	

\*1 The dedicated primer (part number B85AA or B85BB) will be shipped at the same time.

# Bare Concrete 15

Coating performance	Weather resistance	Installation
Hydrophilic Self-cleaning	Weather resistance grade ★★	Installation Horizontal and Vertical



EW3572H

## Specifications

Size	15×455(exposed width)×3030mm
Price	<b>6,500JPY</b> /piece 4,710JPY/m <sup>2</sup>
Number of panel per package	2pieces
Coverage	1.38m <sup>2</sup> /piece
Weight	Approx. 24kg/piece

## Outside corner

15×outside:90(inside:75)×455(exposed width)    15×outside:90(inside:75)×3030

## Accessories list

Genuine accessories are required to install siding panels

Panel	Outside corner l=455	Outside corner l=3030	Through Wall Flashing l=3030	Caulking (Holder set: B80E)	Repair Paint
EW3572H	EWD3572H	EWP3572H	B2241557	B84301403	B93HB1404BNH
Price	<b>3,900JPY</b> /piece	<b>17,100JPY</b> /piece	<b>3,200JPY</b> /piece	<b>6,600JPY</b> /piece	<b>2,900JPY</b> /bottle
Number of panel per package	10 pieces/box (Ordering Unit 1piece)	1piece	5 pieces/box	10 pieces/box*1 (Ordering Unit 1piece) Caulking(600ml)10pieces, Primer,brush,nozzle2pieces	60g/bottle
				*Holder set are sold separately	

\*1 The dedicated primer (part number B85AA or B85BB) will be shipped at the same time.

# Luminous Wood

Coating performance	Weather resistance	Installation
Hydrophilic Self-cleaning	Weather resistance grade ★★	Installation Horizontal and Vertical



EW7361H



EW7362H



EW7363H



EW7364H



EW7365H

## Specifications

Size	15×455(exposed width)×3030mm
Price	<b>6,500JPY</b> /piece 4,710JPY/m <sup>2</sup>
Number of panel per package	2pieces
Coverage	1.38m <sup>2</sup> /piece
Weight	Approx. 25kg/piece

## Outside corner

Shiplap corner

Vertical installation with clips

Outside corner l=455    Outside corner l=3030

15×outside:90(inside:75)×455(exposed width)    15×outside:90(inside:75)×3030

## Accessories list

Genuine accessories are required to install siding panels

Panel	Accessories		Through Wall Flashing l=3030	Caulking (Holder set: B80E)	Repair Paint	
	Outside corner l=455	Outside corner l=3030				
EW7361H	EWD7361H	EWP7361H	B2241457	B84304029	B93HB1603DNH (Light color)	B93HB1603CNH (Dark color)
EW7362H	EWD7362H	EWP7362H	B2241423	B84304030	B93HB2604DNH (Light color)	B93HB2604ENH (Dark color)
EW7363H	EWD7363H	EWP7363H	B22413060	B84304031	B93HB3060BNH (Light color)	B93HB3060CNH (Dark color)
EW7364H	EWD7364H	EWP7364H	B2241W3	B84304032	B93HB1708FNH (Light color)	B93HB1708GNH (Dark color)
EW7365H	EWD7365H	EWP7365H	B2241550	B84302867	B93HB2510ENH	—
Price	<b>3,900JPY</b> /piece	<b>17,100JPY</b> /piece	<b>3,200JPY</b> /piece	<b>6,600JPY</b> /piece	<b>2,900JPY</b> /bottle	
Number of panel per package	10 pieces/box (Ordering Unit 1piece)	1piece	5 pieces/box	10 pieces/box*1 (Ordering Unit 1piece) Caulking(600ml)10pieces, Primer,brush,nozzle2pieces *Holder set are sold separately	60g/bottle	

\*1 The dedicated primer (part number B85AA or B85BB) will be shipped at the same time.

# Clair Wood 15

Coating performance	Weather resistance	Installation
Hydrophilic Self-cleaning	Weather resistance grade ★★	Installation Horizontal and Vertical



EW4239K



EW42310K



EW42311K



EW42312K



EW42313K

## Specifications

Size	15×455(exposed width)×3030mm
Price	<b>6,500JPY</b> /piece 4,710JPY/m <sup>2</sup>
Number of panel per package	2pieces
Coverage	1.38m <sup>2</sup> /piece
Weight	Approx. 24kg/piece

## Outside corner

Outside corner l=455



15×outside:90(inside:75) ×455(exposed width)

Outside corner l=3030



15×outside:90(inside:75) ×3030

Shiplap corner



Vertical installation with clips

## Accessories list

Genuine accessories are required to install siding panels

Panel	Accessories					Repair Paint	
	Outside corner l=455	Outside corner l=3030	Through Wall Flashing l=3030	Caulking (Holder set: B80E)			
EW4239K	EWD4239K	EWP4239K	B2241512	B84302491	B93HB2669ANK	—	
EW42310K	EWD42310K	EWP42310K	B2241W4	B84302636	B93HB2721ANK	—	
EW42311K	EWD42311K	EWP42311K	B2241550	B84304007	B93HB3010CNK (Light color)	B93HB3361ANK (Dark color)	
EW42312K	EWD42312K	EWP42312K	B22413060	B84304009	B93HB3328ANK (Light color)	B93HB3365ANK (Dark color)	
EW42313K	EWD42313K	EWP42313K	B2241W3	B84302417B	B93HB2562BNK	—	
Price	<b>3,900JPY</b> /piece	<b>17,100JPY</b> /piece	<b>3,200JPY</b> /piece	<b>6,600JPY</b> /piece	<b>2,900JPY</b> /bottle		
Number of panel per package	10 pieces/box (Ordering Unit: 1piece)	1piece	5 pieces/box	10 pieces/box*1 (Ordering Unit: 1piece) Caulking(600ml)10pieces, Primer,brush,nozzle2pieces	60g/bottle		
				*Holder set are sold separately			

\*1 The dedicated primer (part number B85AA or B85BB) will be shipped at the same time.

# Cimant Flat

Coating performance	Weather resistance	Installation
Hydrophilic Self-cleaning	Weather resistance grade ★★	Installation Horizontal and Vertical



EW7301H



EW7302H



**A** EW7303H  
**B** EW7303K



**A** EW7304H  
**B** EW7304K



EW7305H

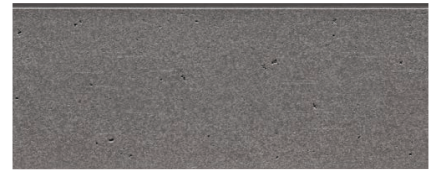

EW7306K



EW7307K

## Specifications

Size	15×455(exposed width)×3030mm
Price	<b>6,500JPY</b> /piece 4,710JPY/m <sup>2</sup>
Number of panel per package	2pieces
Coverage	1.38m <sup>2</sup> /piece
Weight	Approx. 25kg/piece

## Outside corner

Outside corner l=455    Outside corner l=3030    Shiplap corner

Vertical installation with clips

15×outside:90(inside:75)×455(exposed width)    15×outside:90(inside:75)×3030

## Accessories list

Genuine accessories are required to install siding panels

Panel	Accessories	Outside corner l=455	Outside corner l=3030	Through Wall Flashing l=3030	Caulking (Holder set: B80E)	Repair Paint
EW7301H		EWD7301H	EWP7301H	B2241W2	B84302491A	B93HB3257ANH
EW7302H		EWD7302H	EWP7302H	B2241557	B84303990	B93HB2515CNH
<b>A</b> EW7303H		EWD7303H	EWP7303H	B2241550	B84301937	B93HB3213AU
<b>B</b> EW7303K		EWD7303K	EWP7303K	B2241550	B84301937	B93HB3067BNK
<b>A</b> EW7304H		EWD7304H	EWP7304H	B2241550	B84302414	B93HB3326ANH
<b>B</b> EW7304K		EWD7304K	EWP7304K	B2241550	B84302414	B93HB3066ANK
EW7305H		EWD7305H	EWP7305H	B2241549	B8430713B	B93HB783ANH
EW7306K		EWD7306K	EWP7306K	B2241549	B8430749B	B93HB3290ANK
EW7307K		EWD7307K	EWP7307K	B2241W3	B84303045	B93HB3053ANK
Price		<b>3,900JPY</b> /piece	<b>17,100JPY</b> /piece	<b>3,200JPY</b> /piece	<b>6,600JPY</b> /piece	<b>2,900JPY</b> /bottle
Number of panel per package		10 pieces/box (Ordering Unit 1piece)	1piece	5 pieces/box	10 pieces/box <sup>*1</sup> (Ordering Unit 1piece) Caulking[600ml]10pieces, Primer,brush,nozzle2pieces	60g/bottle
						<small>*Holder set are sold separately</small>

\*1 The dedicated primer (part number B85AA or B85BB) will be shipped at the same time.

# Plaster Flat 15

Coating performance	Weather resistance	Installation
Hydrophilic Self-cleaning	Weather resistance grade ★★	Installation Horizontal and Vertical



**A** EW7531H  
**B** EW7531K



**A** EW7532H  
**B** EW7532K



**A** EW7533H  
**B** EW7533K



**A** EW7534H  
**B** EW7534K



**A** EW7535H  
**B** EW7535K



**A** EW7536H  
**B** EW7536K

## Specifications

Size	15×455(exposed width)×3030mm
Price	<b>6,500JPY</b> /piece 4,710JPY/m <sup>2</sup>
Number of panel per package	2pieces
Coverage	1.38m <sup>2</sup> /piece
Weight	Approx. 25kg/piece

## Outside corner

Outside corner l=455    Outside corner l=3030

Shiplap corner

Vertical installation with clips

15×outside:90(inside:75) ×455(exposed width)    15×outside:90(inside:75) ×3030

## Accessories list

Genuine accessories are required to install siding panels

Panel	Outside corner l=455	Outside corner l=3030	Through Wall Flashing l=3030	Caulking (Holder set: B80E)	Repair Paint	
<b>A</b>	EW7531H	EWD7531H	EWP7531H	B2241W2	B84302491A	B93HB2597ANH
	EW7532H	EWD7532H	EWP7532H	B2241417	B84302873	B93HB3257BNH
	EW7533H	EWD7533H	EWP7533H	B2241550	B84302594A	B93HB3327BNH
	EW7534H	EWD7534H	EWP7534H	B2241549	B84303342	B93HB3342BNH
	EW7535H	EWD7535H	EWP7535H	B2241W3	B84301713	B93HB3353ANH
	EW7536H	EWD7536H	EWP7536H	B2241W1	B84303258	B93HB3419ANH
<b>B</b>	EW7531K	EWD7531K	EWP7531K	B2241W2	B84302491A	B93HB3192ANK
	EW7532K	EWD7532K	EWP7532K	B2241417	B8430976B	B93HB3257BNH
	EW7533K	EWD7533K	EWP7533K	B2241550	B84302503	B93HB2720BNK
	EW7534K	EWD7534K	EWP7534K	B2241549	B84303342	B93HB3342BNH
	EW7535K	EWD7535K	EWP7535K	B2241W3	B84302417B	B93HB2562ANK
	EW7536K	EWD7536K	EWP7536K	B2241W1	B84303258	B93HB3091ANK
Price	<b>3,900JPY</b> /piece	<b>17,100JPY</b> /piece	<b>3,200JPY</b> /piece	<b>6,600JPY</b> /piece	<b>2,900JPY</b> /bottle	
Number of panel per package	10 pieces/box (Ordering Unit 1piece)	1piece	5 pieces/box	10 pieces/box <sup>1)</sup> (Ordering Unit 1piece) Caulking(600ml)10pieces, Primer,brush,nozzle2pieces <small>*Holder set are sold separately</small>	60g/bottle	

<sup>1)</sup> The dedicated primer (part number B85AA or B85BB) will be shipped at the same time.

# Orden

Coating performance	Weather resistance	Installation
Hydrophilic Self-cleaning	Weather resistance grade ★★	Installation Horizontal and Vertical



EW7072H



EW7075H

## Specifications

Size	15×455(exposed width)×3030mm
Price	<b>6,500JPY</b> /piece 4,710JPY/m <sup>2</sup>
Number of panel per package	2pieces
Coverage	1.38m <sup>2</sup> /piece
Weight	Approx. 24kg/piece

## Outside corner

Outside corner l=455      Outside corner l=3030

Shiplap corner  
Vertical installation with clips

15×outside:90(inside:75)×455(exposed width)      15×outside:90(inside:75)×3030

## Accessories list

Genuine accessories are required to install siding panels

Accessories	Outside corner l=455	Outside corner l=3030	Through Wall Flashing l=3030	Caulking (Holder set: B80E)	Repair Paint
Panel					
EW7072H	EWD7072H	EWP7072H	B2241462	B84301758A	B93HB1428BNH
EW7075H	EWD7075H	EWP7075H	B2241W1	B84303045	B93HB3258BNH
Price	<b>3,900JPY</b> /piece	<b>17,100JPY</b> /piece	<b>3,200JPY</b> /piece	<b>6,600JPY</b> /piece	<b>2,900JPY</b> /bottle
Number of panel per package	10 pieces/box (Ordering Unit 1piece)	1piece	5 pieces/box	10 pieces/box <sup>*1</sup> (Ordering Unit 1piece) Caulking(600ml)10pieces, Primer,brush,nozzle2pieces <small>*Holder set are sold separately</small>	60g/bottle

\*1 The dedicated primer (part number B85AA or B85BB) will be shipped at the same time.

# Pebble

Coating performance	Weather resistance	Installation
Hydrophilic Self-cleaning	Weather resistance grade ★★	Installation Horizontal



EW7371K



EW7372K



EW7373K



EW7374K



EW7375K

## Specifications

Size	15×455(exposed width)×3030mm
Price	<b>6,500JPY</b> /piece 4,710JPY/m <sup>2</sup>
Number of panel per package	2pieces
Coverage	1.38m <sup>2</sup> /piece
Weight	Approx. 24kg/piece

## Outside corner



## Accessories list

Genuine accessories are required to install siding panels

Panel	Accessories	Outside corner l=455	Caulking (Holder set: B80E)	Repair Paint
EW7371K		EWD7371K	B84303044	B93HB3064ANK
EW7372K		EWD7372K	B84302491A	B93HB2551ANK
EW7373K		EWD7373K	B84301615	B93HB788ANK
EW7374K		EWD7374K	B8430462	B93HB747DNK
EW7375K		EWD7375K	B8430709	B93HB709DNK
Price		<b>3,900JPY</b> /piece	<b>6,600JPY</b> /piece	<b>2,900JPY</b> /bottle
Number of panel per package		10 pieces/box (Ordering Unit 1piece)	10 pieces/box <sup>1)</sup> (Ordering Unit 1piece) Caulking(600ml)10pieces, Primer,brush, nozzle2pieces	60g/bottle
			*Holder set are sold separately	

<sup>1)</sup> The dedicated primer (part number B85AA or B85BB) will be shipped at the same time.

# Elenore

Coating performance	Weather resistance	Installation
Hydrophilic Self-cleaning	Weather resistance grade ★★	Installation Horizontal



EW7061K



EW7063K

## Specifications

Size	15×455(exposed width)×3030mm
Price	<b>6,500JPY</b> /piece 4,710JPY/m <sup>2</sup>
Number of panel per package	2pieces
Coverage	1.38m <sup>2</sup> /piece
Weight	Approx. 23kg/piece

## Outside corner



## Accessories list

Genuine accessories are required to install siding panels

Panel	Accessories	Outside corner l=455	Caulking (Holder set: B80E)	Repair Paint
EW7061K		EWD7061K	B84302491C	B93HB2551ANK
EW7063K		EWD7063K	B84304040	B93HB2600ANK
Price		<b>3,900JPY</b> /piece	<b>6,600JPY</b> /piece	<b>2,900JPY</b> /bottle
Number of panel per package		10 pieces/box (Ordering Unit 1piece)	10 pieces/box <sup>*1</sup> (Ordering Unit 1piece) Caulking(600ml)10pieces, Primer,brush, nozzle2pieces	60g/bottle
			*Holder set are sold separately	

\*1 The dedicated primer (part number B85AA or B85BB) will be shipped at the same time.

# Alivio

Coating performance	Weather resistance	Installation
Hydrophilic Self-cleaning	Weather resistance grade ★★	Installation Horizontal



EW7101K



EW7103K

## Specifications

Size	15×455(exposed width)×3030mm
Price	<b>6,500JPY</b> /piece 4,710JPY/m <sup>2</sup>
Number of panel per package	2pieces
Coverage	1.38m <sup>2</sup> /piece
Weight	Approx. 24kg/piece

## Outside corner

Outside corner l=455

15×outside:90(inside:75) ×455(exposed width)

## Accessories list

Genuine accessories are required to install siding panels

Panel	Accessories	Outside corner l=455	Caulking (Holder set: B80E)	Repair Paint
EW7101K		EWD7101K	B84303044	B93HB3064ANK
EW7103K		EWD7103K	B84302546	B93HB1765ANK
Price		<b>3,900JPY</b> /piece	<b>6,600JPY</b> /piece	<b>2,900JPY</b> /bottle
Number of panel per package		10 pieces/box (Ordering Unit 1piece)	10 pieces/box <sup>*1</sup> (Ordering Unit 1piece) Caulking(600ml)10pieces, Primer,brush, nozzle2pieces	60g/bottle
			*Holder set are sold separately	

\*1 The dedicated primer (part number B85AA or B85BB) will be shipped at the same time.

# Smash Line 15

Coating performance	Weather resistance	Installation
Hydrophilic Self-cleaning	Weather resistance grade ★★	Installation Horizontal



**A** EW4221H  
**B** EW4221K



**A** EW4222H  
**B** EW4222K



**A** EW4223H  
**B** EW4223K



**A** EW4224H  
**B** EW4224K



**A** EW4225H  
**B** EW4225K



**A** EW4226H  
**B** EW4226K

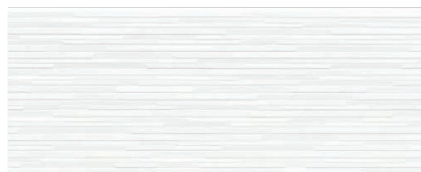

**A** EW4228H  
**B** EW4228K

## Specifications

Size	15×455(exposed width)×3030mm
Price	<b>6,500JPY</b> /piece 4,710JPY/m <sup>2</sup>
Number of panel per package	2pieces
Coverage	1.38m <sup>2</sup> /piece
Weight	Approx. 24kg/piece

## Outside corner



## Accessories list

Genuine accessories are required to install siding panels

Panel	Accessories	Outside corner l=455	Caulking (Holder set: B80E)	Repair Paint
<b>A</b>	EW4221H	EWD4221H	B84302491A	B93HB2597ANH
	EW4222H	EWD4222H	B8430746	B93HB1484CNH
	EW4223H	EWD4223H	B84302503	B93HB2594ANH
	EW4224H	EWD4224H	B8430709	B93HB1708BNH
	EW4225H	EWD4225H	B8430495	B93HB1602ANH
	EW4226H	EWD4226H	B84301758A	B93HB1428ANH
	EW4228H	EWD4228H	B84303044	B93HB3300ANH
	EW4221K	EWD4221K	B84302491A	B93HB2551ANK
<b>B</b>	EW4222K	EWD4222K	B8430746	B93HB746ANK
	EW4223K	EWD4223K	B84302503	B93HB2720BNK
	EW4224K	EWD4224K	B8430709	B93HB709ENK
	EW4225K	EWD4225K	B8430495	B93HB644CNK
	EW4226K	EWD4226K	B84301758A	B93HB747BNK
	EW4228K	EWD4228K	B84303044	B93HB3064ANK
	Price	<b>3,900JPY</b> /piece	<b>6,600JPY</b> /piece	<b>2,900JPY</b> /bottle
	Number of panel per package	10 pieces/box (Ordering Unit 1piece)	10 pieces/box <sup>*1</sup> (Ordering Unit 1piece) Caulking(600ml)10pieces, Primer,brush, nozzle2pieces <small>*Holder set are sold separately</small>	60g/bottle

\*1 The dedicated primer (part number B85AA or B85BB) will be shipped at the same time.

# Placido 15

Coating performance	Weather resistance	Installation
Hydrophilic Self-cleaning	Weather resistance grade ★★	Installation Horizontal



EW3871H



EW38710H



EW38711H

## Specifications

Size	15×455(exposed width)×3030mm
Price	<b>6,500JPY</b> /piece 4,710JPY/m <sup>2</sup>
Number of panel per package	2pieces
Coverage	1.38m <sup>2</sup> /piece
Weight	Approx. 23kg/piece

## Outside corner



## Accessories list

Genuine accessories are required to install siding panels

Panel	Accessories	Outside corner l=455	Caulking (Holder set: B80E)	Repair Paint
EW3871H		EWD3871H	B8430495	B93HB1602ANH
EW38710H		EWD38710H	B84302491A	B93HB2597ANH
EW38711H		EWD38711H	B8430976	B93HB2819ANH
Price		<b>3,900JPY</b> /piece	<b>6,600JPY</b> /piece	<b>2,900JPY</b> /bottle
Number of panel per package		10 pieces/box (Ordering Unit 1piece)	10 pieces/box <sup>*1</sup> (Ordering Unit 1piece) Caulking(600ml)10pieces, Primer,brush,nozzle2pieces	60g/bottle
			*Holder set are sold separately	

\*1 The dedicated primer (part number B85AA or B85BB) will be shipped at the same time.

# Luge 15

Coating performance	Weather resistance	Installation
Hydrophilic Self-cleaning	Weather resistance grade ★★	Installation Horizontal



EW7381H



EW7382H



EW7383H



EW7384H



EW7385H



EW7386H

## Specifications

Size	15×455(exposed width)×3030mm
Price	<b>6,500JPY</b> /piece 4,710JPY/m <sup>2</sup>
Number of panel per package	2pieces
Coverage	1.38m <sup>2</sup> /piece
Weight	Approx. 24kg/piece

## Outside corner



## Accessories list

Genuine accessories are required to install siding panels

Panel	Accessories	Outside corner l=455	Caulking (Holder set: B80E)	Repair Paint
EW7381H		EWD7381H	B84302491A	B93HB2597ANH
EW7382H		EWD7382H	B8430495	B93HB1602ANH
EW7383H		EWD7383H	B84301616	B93HB1746ANH
EW7384H		EWD7384H	B84302652	B93HB2594BNH
EW7385H		EWD7385H	B84303212	B93HB3342BNH
EW7386H		EWD7386H	B8430709	B93HB3258BNH
Price		<b>3,900JPY</b> /piece	<b>6,600JPY</b> /piece	<b>2,900JPY</b> /bottle
Number of panel per package		10 pieces/box (Ordering Unit 1piece)	10 pieces/box <sup>*1</sup> (Ordering Unit 1piece) Caulking(600ml)10pieces, Primer,brush,nozzle2pieces <small>*Holder set are sold separately</small>	60g/bottle

\*1 The dedicated primer (part number B85AA or B85BB) will be shipped at the same time.

# Horizontal Application (for 5mm panel clip)

Products

Legerair Filltect Neorock Excellage Ceradier

Clip(5mm)				
	Panel Clip		Corner Clip	Starter bar for horizontal application
Shape				
Item number	<b>B1005</b>	<b>B1305</b>	<b>B10053</b>	<b>B101052</b>
Price	11,200JPY/bag	12,000JPY/bag	6,400JPY/bag	2,100JPY/piece
Number of panel per package	70 pieces/bag		50 pieces/bag	4 pieces/box
Material	Hot-dip zinc-aluminum magnesium alloy coated steel		Hot-dip zinc-aluminum magnesium alloy coated steel	Hot-dip zinc-aluminum magnesium alloy coated steel

Clip Fixing Component					
	Clip Screw25 (for wood substructure)	Clip Screw35 (for wood substructure)	Clip Screw19 (for steel substructure)	Clip Screw16 (for steel substructure)	Clip Screw30 (for steel substructure)
Shape					
Item number	<b>RY8830</b>	<b>B881135</b>	<b>RY8840</b>	<b>B885116</b>	<b>B885130</b>
Price	10,500JPY/box	10,500JPY/box	13,600JPY/box	15,100JPY/box	19,000JPY/box
Number of panel per package	500 pieces/box	500 pieces/box	500 pieces/box	500 pieces/box	500 pieces/box
Material	Stainless Steel	Stainless Steel	Stainless Steel	Stainless Steel	Stainless Steel

Spacer		
	Spacer5 (for openings and eaves)	Spacer2 (for land adjustment)
Shape		
Item number	<b>RY82S05</b>	<b>RY82S02</b>
Price	21,700JPY/box	18,000JPY/box
Number of panel per package	20 pieces/box	20 pieces/box
Material	Polypropylene	Polypropylene

Flashing		
Internal Flashing	Sill Flashing50	Through Wall Flashing For 18/16/15mm thickness
<b>RCILK</b>	black <b>B238W1</b> white <b>B238W2</b> brown <b>B238W3</b> gray(metalic) <b>B238W4</b>	
1,400JPY/piece	3,200JPY/piece	3,200JPY/piece
20 pieces/box	5 pieces/box	5 pieces/box
Coated galvanized steel	Coated galvanized steel	Coated galvanized steel

Soffit Flashing		
	For 21/18mm thickness	For 16/15mm thickness
Shape		
	black <b>B257W1</b> white <b>B257W2</b> brown <b>B257W3</b> gray <b>B257W4</b>	black <b>B256W1</b> white <b>B256W2</b> brown <b>B256W3</b> gray <b>B256W4</b>
Price	4,800JPY/piece	4,200JPY/piece
Number of panel per package	5 pieces/box	5 pieces/box
Material	Coated galvanized steel	Coated galvanized steel

Repair Component
Repair Putty
<b>B4901</b>
3,700JPY/piece
1 pieces/350g
Acrylic emulsion

Long Clip	
<b>B10055</b>	
<b>3,800 JPY/piece</b>	
6 pieces/box	
Hot-dip zinc-aluminum magnesium alloy coated steel	

Face Nail / Screw				
Face Nail50(for wood substructure)	Face Nail45(for wood substructure)	Face Screw50 (for steel substructure)	Face Screw45 (for steel substructure)	Face Screw35 (for steel substructure)
For 21/18mm thickness	For 16/15mm thickness			
<b>B8750R400</b>	<b>B8745R400</b>	<b>B88501</b>	<b>B885245</b>	<b>B8852135</b>
<b>790 JPY/bag</b>	<b>580 JPY/bag</b>	<b>9,500 JPY/box</b>	<b>15,600 JPY/box</b>	<b>14,000 JPY/box</b>
40 pieces/bag	40 pieces/bag	200 pieces/box	300 pieces/box	300 pieces/box
Stainless Steel	Stainless Steel	Stainless Steel	Stainless Steel	Stainless Steel

Joint Component			
Metal Caulking Joiner			
For 15mm thickness	For 15mm thickness(one-side)	For 16mm or more thickness	For 16mm or more thickness(one-side)
<b>B2715</b>	<b>B2715K</b>	<b>B2721</b>	<b>B2718K</b>
<b>1,900 JPY/piece</b>	<b>1,800 JPY/piece</b>	<b>2,000 JPY/piece</b>	<b>2,000 JPY/piece</b>
15 pieces/box	15 pieces/box	15 pieces/box	15 pieces/box
Hot-dip zinc-aluminum magnesium alloy coated steel	Hot-dip zinc-aluminum magnesium alloy coated steel	Hot-dip zinc-aluminum magnesium alloy coated steel	Hot-dip zinc-aluminum magnesium alloy coated steel

Joint Component	
T-shaped joiner	L-shaped joiner
black <b>B3616F1</b> white <b>B3616F2</b> brown <b>B3616F3</b> dark stainless <b>B3616F4</b>	black <b>B3616KF1</b> white <b>B3616KF2</b> brown <b>B3616KF3</b> dark stainless <b>B3616KF4</b>
<b>6,500 JPY/piece</b>	<b>6,100 JPY/piece</b>
15 pieces/box	15 pieces/box
Aluminum	Aluminum

Waterproof Component	
Waterproof Sealer	Waterproof Sealer for Filteck
<b>RM875</b>	<b>LTKBM3103C</b>
<b>3,600 JPY/bottle</b>	<b>23,300 JPY/bottle</b>
1 bottle/100g	1 bottle/1liter
—	—

# Virtical Application (for 5mm panel clip)

Products

Filltect

Neorock

Excellage



Ceradier



Clip(5mm)					
	Panel Clip		Corner Clip	Starter bar for vertical application	
	t=0.8mm		t=0.8mm	For 16/15mm thickness	For 18mm thickness
Shape					
Item number	<b>B1005</b>	<b>B1305</b>	<b>RE10058</b>	<b>B130571</b>	<b>B1320572</b>
Price	11,200JPY/bag	12,000JPY/bag	4,400JPY/bag	6,500JPY/piece	5,900JPY/piece
Number of panel per package	70 pieces/bag		34 pieces/bag	5 pieces/box	5 pieces/box
Material	Hot-dip zinc-aluminum magnesium alloy coated steel		Hot-dip zinc-aluminum magnesium alloy coated steel	Hot-dip zinc-aluminum magnesium alloy coated steel	Hot-dip zinc-aluminum magnesium alloy coated steel

Face Nail / Screw					
	Face Nail50(for wood substructure)	Face Nail45(for wood substructure)	Face Screw50 (for steel substructure)	Face Screw45 (for steel substructure)	Face Screw60 (for steel substructure)
	For 18mm thickness	For 16/15mm thickness			
Shape					
Item number	<b>B8750R400</b>	<b>B8745R400</b>	<b>B88501</b>	<b>B885245</b>	<b>B885260</b>
Price	790JPY/bag	580JPY/bag	9,500JPY/box	15,600JPY/box	12,500JPY/box
Number of panel per package	40 pieces/bag	40 pieces/bag	200 pieces/box	300 pieces/box	200 pieces/box
Material	Stainless Steel	Stainless Steel	Stainless Steel	Stainless Steel	Stainless Steel

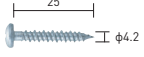
Spacer			Flashing	
	Spacer5 (for openings and eaves)	Spacer2 (for land adjustment)	Internal Flashing	Sill Flashing 50
	Shape			
Item number	<b>RY82S05</b>	<b>RY82S02</b>	<b>RCILK</b>	
Price	21,700JPY/box	18,000JPY/box	1,400JPY/piece	3,200JPY/piece
Number of panel per package	20 pieces/box	20 pieces/box	20 pieces/box	5 pieces/box
Material	Polypropylene	Polypropylene	Coated galvanized steel	Coated galvanized steel

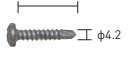
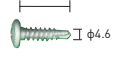
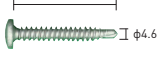
Repair Component		Waterproof Component	
	Repair Putty	Waterproof Sealer	Waterproof Sealer for Filltect
	Shape		
Item number	<b>B4901</b>	<b>RM875</b>	<b>LTKBM3103C</b>
Price	3,700JPY/piece	3,600JPY/bottle	23,300JPY/bottle
Number of panel per package	1 pieces/350g	1 bottle/100g	1 bottle/1liter
Material	Acrylic emulsion	—	—

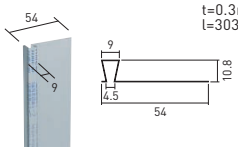
		Clip Fixing Component				
Corner cap for starter bar		Clip Screw25 (for wood substructure)	Clip Screw35 (for wood substructure)	Clip Screw19 (for steel substructure)	Clip Screw16 (for steel substructure)	Clip Screw30 (for steel substructure)
				 Sub Structure thickness :1.6 to 2.3mm	 Sub Structure thickness :1.2mm	 Sub Structure thickness :1.2mm
<b>B293W1D</b>		<b>RY8830</b>	<b>B881135</b>	<b>RY8840</b>	<b>B885116</b>	<b>B885130</b>
3,900JPY/bag		10,500JPY/box	10,500JPY/box	13,600JPY/box	15,100JPY/box	19,000JPY/box
10 pieces/bag		500 pieces/box	500 pieces/box	500 pieces/box	500 pieces/box	500 pieces/box
Coated galvanized steel		Stainless Steel	Stainless Steel	Stainless Steel	Stainless Steel	Stainless Steel

Joint Component		
Metal Caulking Joiner(one-side)	T-shaped joiner	L-shaped joiner
 t=0.3mm l=3030mm	 t=1.2mm l=3000mm	 t=1.2mm l=3000mm
black B3616F1 white B3616F2 brown B3616F3 dark stainless B3616F4		black B3616KF1 white B3616KF2 brown B3616KF3 dark stainless B3616KF4
<b>B2715K</b>		
1,800JPY/piece	6,500JPY/piece	6,100JPY/piece
15 pieces/box	15 pieces/box	15 pieces/box
Hot-dip zinc-aluminum magnesium alloy coated steel	Aluminum	Aluminum

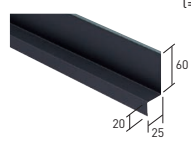
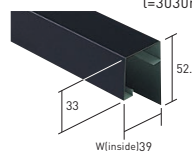
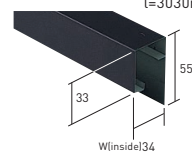
		Soffit Flashing	
Through Wall Flashing		For 21/18mm thickness	For 16/15mm thickness
For 18/16/15mm thickness			
 t=0.3mm l=3030mm		 t=0.35mm l=3030mm	 t=0.35mm l=3030mm
		black B257W1 white B257W2 brown B257W3 gray B257W4	black B256W1 white B256W2 brown B256W3 gray B256W4
3,200JPY/piece		4,800JPY/piece	4,200JPY/piece
5 pieces/box		5 pieces/box	5 pieces/box
Coated galvanized steel		Coated galvanized steel	Coated galvanized steel

# Horizontal Application (for 15mm panel clip)

Products

Legerair   Filltect   Neorock   Excellage   Ceradier

Clip(15mm)				
	Panel Clip	Corner Clip	Starter bar for horizontal application	
Shape				
Item number	<b>B10115</b>	<b>B101153</b>	<b>B101152</b>	
Price	<b>5,800JPY/bag</b>	<b>3,000JPY/bag</b>	<b>3,900JPY/piece</b>	
Number of panel per package	30 pieces/bag	20 pieces/bag	4 pieces/box	
Material	Hot-dip zinc-aluminum magnesium alloy coated steel	Hot-dip zinc-aluminum magnesium alloy coated steel	Hot-dip zinc-aluminum magnesium alloy coated steel	

Clip Fixing Component				
	Clip Screw25 (for wood substructure)	Clip Screw35 (for wood substructure)	Clip Screw55 (for wood substructure)	Clip Screw19 (for steel substructure)
Shape				 Sub Structure thickness :1.6 to 2.3mm
Item number	<b>RY8830</b>	<b>B881135</b>	<b>B88553</b>	<b>RY8840</b>
Price	<b>10,500JPY/box</b>	<b>10,500JPY/box</b>	<b>9,200JPY/box</b>	<b>13,600JPY/box</b>
Number of panel per package	500 pieces/box	500 pieces/box	200 pieces/box	500 pieces/box
Material	Stainless Steel	Stainless Steel	Stainless Steel	Stainless Steel

Face Nail / Screw					
	Face Nail65 (for wood substructure) 21/For 18/16/15mm thickness	Face Screw60 (for steel substructure) For 21mm thickness	Face Screw50 (for steel substructure) For 18/16/15mm thickness	Face Screw45 (for steel substructure)	Face Screw60 (for steel substructure)
Shape					
Item number	<b>B8765R400</b>	<b>B8860</b>	<b>B88501</b>	<b>B885245</b>	<b>B885260</b>
Price	<b>1,250JPY/bag</b>	<b>14,900JPY/box</b>	<b>9,500JPY/box</b>	<b>15,600JPY/box</b>	<b>12,500JPY/box</b>
Number of panel per package	40 pieces/bag	200 pieces/box	200 pieces/box	300 pieces/box	200 pieces/box
Material	Stainless Steel	Stainless Steel	Stainless Steel	Stainless Steel	Stainless Steel

Flashing			Soffit Flashing		
	Internal Flashing	Sill Flashing 50	For 21/18mm thickness	For 16/15mm thickness	
Shape					
Item number	<b>RCILK</b>	black <b>B238W1</b> white <b>B238W2</b> brown <b>B238W3</b> gray(metalic) <b>B238W4</b>	black <b>B257W1</b> white <b>B257W2</b> brown <b>B257W3</b> gray <b>B257W4</b>	black <b>B256W1</b> white <b>B256W2</b> brown <b>B256W3</b> gray <b>B256W4</b>	
Price	<b>1,400JPY/piece</b>	<b>3,200JPY/piece</b>	<b>4,800JPY/piece</b>	<b>4,200JPY/piece</b>	
Number of panel per package	20 pieces/box	5 pieces/box	5 pieces/box	5 pieces/box	
Material	Coated galvanized steel	Coated galvanized steel	Coated galvanized steel	Coated galvanized steel	

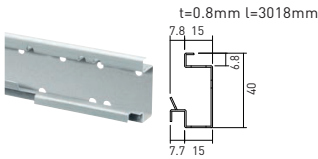
	<b>Long clip</b>
	 <p>t=0.8mm l=3018mm</p>
	<b>B10155</b>
	4,000JPY/piece
	6 pieces/box
	Hot-dip zinc-aluminum magnesium alloy coated steel

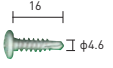
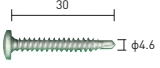
	<b>Clip Screw16 (for steel substructure)</b>	<b>Clip Screw30 (for steel substructure)</b>
	 <p>Sub Structure thickness :1.2mm</p>	 <p>Sub Structure thickness :1.2mm</p>
	<b>B885116</b>	<b>B885130</b>
	15,100JPY/box	19,000JPY/box
	500 pieces/box	500 pieces/box
	Stainless Steel	Stainless Steel

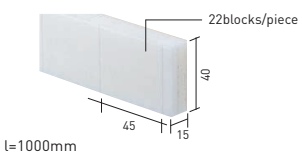
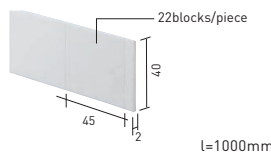
Spacer	
<b>Spacer15 (for openings and eaves)</b>	<b>Spacer2 (for land adjustment)</b>
 <p>22blocks/piece l=1000mm</p>	 <p>22blocks/piece l=1000mm</p>
<b>RY82S15</b>	<b>RY82S02</b>
15,200JPY/box	18,000JPY/box
6 pieces/box	20 pieces/box
Polypropylene	Polypropylene

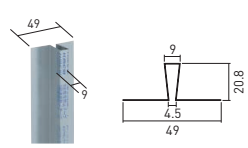
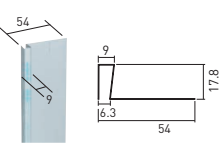
Joint Component	
Metal Caulking Joiner	
<b>For 15mm thickness</b>	<b>For 15mm thickness(one-side)</b>
	
<b>B2716</b>	<b>B2716K</b>
3,100JPY/piece	3,100JPY/piece
15 pieces/box	15 pieces/box
Hot-dip zinc-aluminum magnesium alloy coated steel	Hot-dip zinc-aluminum magnesium alloy coated steel

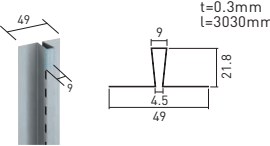
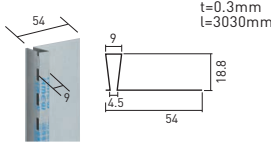
Joint Component	
Metal Caulking Joiner	
<b>For 16mm or more thickness</b>	<b>For 16mm or more thickness(one-side)</b>
 <p>t=0.3mm l=3030mm</p>	 <p>t=0.3mm l=3030mm</p>
<b>B2722</b>	<b>B2719K</b>
3,400JPY/piece	3,500JPY/piece
15 pieces/box	15 pieces/box
Hot-dip zinc-aluminum magnesium alloy coated steel	Hot-dip zinc-aluminum magnesium alloy coated steel

Repair Component	Waterproof Component	
Repair Putty	Waterproof Sealer	Waterproof Sealer for Filtect
		
<b>B4901</b>	<b>RM875</b>	<b>LTKBM3103C</b>
3,700JPY/piece	3,600JPY/bottle	23,300JPY/bottle
1 pieces/350g	1 bottle/100g	1 bottle/1liter
Acrylic emulsion	—	—

# Virtical Application (for 15mm panel clip)



Products



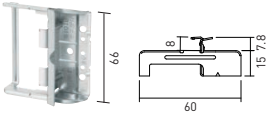
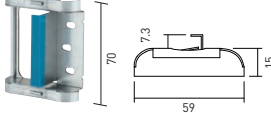

Filltect

Neorock



Excellage

Ceradier

Clip(15mm)			
	Panel Clip	Corner Clip	Starter bar for vertical application
			For 16/15mm thickness
Shape	 t=0.8mm 66, 60, 15 7.8	 t=0.8mm 70, 7.3, 15, 59	 t=0.8mm l=3030mm 36, 38.6
Item number	<b>B10115</b>	<b>RE10158</b>	<b>B1321571</b>
Price	<b>5,800JPY/bag</b>	<b>8,500JPY/bag</b>	<b>5,600JPY/piece</b>
Number of panel per package	30 pieces/bag	34 pieces/bag	5 pieces/box
Material	Hot-dip zinc-aluminum magnesium alloy coated steel	Hot-dip zinc-aluminum magnesium alloy coated steel	Hot-dip zinc-aluminum magnesium alloy coated steel

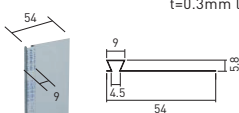
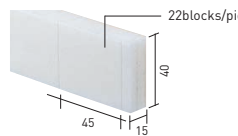
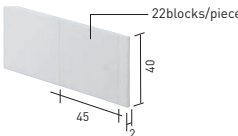
Clip Fixing Component					
	Clip Screw25 (for wood substructure)	Clip Screw35 (for wood substructure)	Clip Screw19 (for steel substructure)	Clip Screw16 (for steel substructure)	Clip Screw30 (for steel substructure)
Shape	 25, φ4.2	 35, φ4.1	 19, φ4.2 Sub Structure thickness :1.6 to 2.3mm	 16, φ4.6 Sub Structure thickness :1.2mm	 30, φ4.6 Sub Structure thickness :1.2mm
Item number	<b>RY8830</b>	<b>B881135</b>	<b>RY8840</b>	<b>B885116</b>	<b>B885130</b>
Price	<b>10,500JPY/box</b>	<b>10,500JPY/box</b>	<b>13,600JPY/box</b>	<b>15,100JPY/box</b>	<b>19,000JPY/box</b>
Number of panel per package	500 pieces/box	500 pieces/box	500 pieces/box	500 pieces/box	500 pieces/box
Material	Stainless Steel	Stainless Steel	Stainless Steel	Stainless Steel	Stainless Steel

Joint Component		Spacer	
	Metal Caulking Joiner(one-side)	Spacer15 (for openings and eaves)	Spacer2 (for land adjustment)
Shape	 t=0.3mm l=3030mm 54, 9, 4.5, 1.25	 22blocks/piece l=1000mm, 45, 15, 40	 22blocks/piece l=1000mm, 45, 2, 40
Item number	<b>B2713K</b>	<b>RY82S15</b>	<b>RY82S02</b>
Price	<b>1,570JPY/piece</b>	<b>15,200JPY/box</b>	<b>18,000JPY/box</b>
Number of panel per package	15 pieces/box	6 pieces/box	20 pieces/box
Material	Hot-dip zinc-aluminum magnesium alloy coated steel	Polypropylene	Polypropylene

Repair Component		Waterproof Component	
	Repair Putty	Waterproof Sealer	Waterproof Sealer for Filltect
Shape			
Item number	<b>B4901</b>	<b>RM875</b>	<b>LTKBM3103C</b>
Price	<b>3,700JPY/piece</b>	<b>3,600JPY/bottle</b>	<b>23,300JPY/bottle</b>
Number of panel per package	1 pieces/350g	1 bottle/100g	1 bottle/1liter
Material	Acrylic emulsion	—	—

Starter bar for vertical application		Corner cap for starter bar
For 18mm thickness		
<b>B1321572</b>		<b>B291W1D</b>
5,900JPY/piece		3,900JPY/bag
5 pieces/box		10 pieces/bag
Hot-dip zinc-aluminum magnesium alloy coated steel		Coated galvanized steel

Face Nail / Screw			
Face Nail65(for wood substructure)	Face Screw50(for steel substructure)	Face Screw45 (for steel substructure)	Face Screw60 (for steel substructure)
For 18/16/15mm thickness	For 18/16/15mm thickness		
	 Sub Structure thickness :1.6 to 2.3mm	 Sub Structure thickness :1.2mm	 Sub Structure thickness :1.2mm
<b>B8765R400</b>	<b>B88501</b>	<b>B885245</b>	<b>B885260</b>
1,250JPY/bag	9,500JPY/box	15,600JPY/box	12,500JPY/box
40 pieces/bag	200 pieces/box	300 pieces/box	200 pieces/box
Stainless Steel	Stainless Steel	Stainless Steel	Stainless Steel

Flashing	
Internal Flashing	Sill Flashing 50
 t=0.35mm l=3030mm	 t=0.35mm l=3030mm
<b>RCILK</b>	black <b>B238W1</b> white <b>B238W2</b> brown <b>B238W3</b> gray(metalic) <b>B238W4</b>
1,400JPY/piece	3,200JPY/piece
20 pieces/box	5 pieces/box
Coated galvanized steel	Coated galvanized steel

Soffit Flashing	
For 21/18mm thickness	For 16/15mm thickness
 t=0.35mm l=3030mm	 t=0.35mm l=3030mm
black <b>B257W1</b> white <b>B257W2</b> brown <b>B257W3</b> gray <b>B257W4</b>	black <b>B256W1</b> white <b>B256W2</b> brown <b>B256W3</b> gray <b>B256W4</b>
4,800JPY/piece	4,200JPY/piece
5 pieces/box	5 pieces/box
Coated galvanized steel	Coated galvanized steel



**KMEW Co.,Ltd.**

Head office: 13F, Crystal Tower Bldg.,  
1-2-27 Shiromi, Chuo-ku, Osaka, Japan